



USER MANUAL

VIA VAB-950

Fanless low-power platform for
AIoT applications with octa-core
MediaTek i500 processor



Copyright

Copyright © 2020 VIA Technologies Incorporated. All rights reserved.

No part of this document may be reproduced, transmitted, transcribed, stored in a retrieval system, or translated into any language, in any form or by any means, electronic, mechanical, magnetic, optical, chemical, manual or otherwise without the prior written permission of VIA Technologies, Incorporated.

Trademarks

All trademarks are the property of their respective holders.

Disclaimer

No license is granted, implied or otherwise, under any patent or patent rights of VIA Technologies. VIA Technologies makes no warranties, implied or otherwise, in regard to this document and to the products described in this document. The information provided in this document is believed to be accurate and reliable as of the publication date of this document. However, VIA Technologies assumes no responsibility for the use or misuse of the information (including use or connection of extra device/equipment/add-on card) in this document and for any patent infringements that may arise from the use of this document. The information and product specifications within this document are subject to change at any time, without notice and without obligation to notify any person of such change.

VIA Technologies, Inc. reserves the right to make changes to the products described in this manual at any time without prior notice.

Regulatory Compliance

FCC-A Radio Frequency Interference Statement

This equipment has been tested and found to comply with the limits for a class A digital device, pursuant to part 15 of the FCC rules. These limits are designed to provide reasonable protection against harmful interference when the equipment is operated in a commercial environment. This equipment generates, uses, and can radiate radio frequency energy and, if not installed and used in accordance with the instruction manual, may cause harmful interference to radio communications. Operation of this equipment in a residential area is likely to cause harmful interference, in which case the user will be required to correct the interference at his personal expense.

Notice 1

The changes or modifications not expressly approved by the party responsible for compliance could void the user's authority to operate the equipment.

Notice 2

Shielded interface cables and A.C. power cord, if any, must be used in order to comply with the emission limits.

Notice 3

The product described in this document is designed for general use, VIA Technologies assumes no responsibility for the conflicts or damages arising from incompatibility of the product. Check compatibility issue with your local sales representatives before placing an order.



Tested To Comply
With FCC Standards
FOR HOME OR OFFICE USE



Battery Recycling and Disposal

- Only use the appropriate battery specified for this product.
- Do not re-use, recharge, or reheat an old battery.
- Do not attempt to force open the battery.
- Do not discard used batteries with regular trash.
- Discard used batteries according to local regulations.



Safety Precautions

- Always read the safety instructions carefully.
- Keep this User's Manual for future reference.
- All cautions and warnings on the equipment should be noted.
- Keep this equipment away from humidity.
- Put this equipment on a reliable flat surface before setting it up.
- Check the voltage of the power source and adjust to 110/220V before connecting the equipment to the power inlet.
- Do not place the power cord where people will step on it.
- Always unplug the power cord before inserting any add-on card or module.
- If any of the following situations arise, get the equipment checked by authorized service personnel:
 - The power cord or plug is damaged.
 - Liquid has entered into the equipment.
 - The equipment has been exposed to moisture.
 - The equipment is faulty or you cannot get it work according to User's Manual.
 - The equipment has been dropped and damaged.
 - The equipment has an obvious sign of breakage.
- Do not leave this equipment in extreme temperatures or in a storage temperature above 60°C (140°F). The equipment may be damaged.
- Do not leave this equipment in direct sunlight.
- Never pour any liquid into the opening. Liquid can cause damage or electrical shock.
- Do not place anything over the power cord.
- Do not cover the ventilation holes. The openings on the enclosure protect the equipment from overheating.

Box Contents

- 1 x VIA VAB-950 board
- 1 x DC power jack cable

Ordering Information

Part Number	Description
10GMV20620020	EPIC board and SOM module with 2.0GHz MediaTek i500 octa-core Processor, 16GB eMMC, 2GB LPDDR4 SDRAM, HDMI, USB 2.0, Micro USB 2.0, DSI, CSI, COM, GPIO, 2 10/100Mbps Ethernet, miniPCIe, SIM card slot, Wi-Fi + Bluetooth 5.0, 12V DC-in
10GMV20610020	EPIC board and SOM module with 2.0GHz MediaTek i500 octa-core Processor, 16GB eMMC, 4GB LPDDR4 SDRAM, HDMI, USB 2.0, Micro USB 2.0, DSI, CSI, COM, GPIO, 2 10/100Mbps Ethernet, miniPCIe, SIM card slot, Wi-Fi + Bluetooth 5.0, 12V DC-in
10GMU20600020	SOM module with 2.0GHz MediaTek i500 octa-core Processor, 16GB eMMC, 2GB LPDDR4 SDRAM
10GMU20610020	SOM module with 2.0GHz MediaTek i500 octa-core Processor, 16GB eMMC, 4GB LPDDR4 SDRAM

Optional Accessories

AC-to-DC Adapter

Part Number	Description
99G63-020516	AC-to-DC adapter, DC 12V, 36W (Power cord not included)

MIPI DSI LCD Panel

Part Number	Description
99G47-01025F	10.1" WUXGA 16:10 Color TFT-LCD with LED Backlight

Wireless Accessories

Part Number	Description
EMIO-2574-00A0	SIM7600JC-H-PCIE 4G LTE mobile broadband full-size miniPCIe module with assembly kit and antenna (for Docomo/KDDI/Softbank)

Table of Contents

1.	Product Overview	1
1.1	Key Features	1
1.2	Product Specifications	2
1.3	Layout Diagram	4
1.4	Product Dimensions	5
1.5	Height Distribution	6
2.	External I/O Pin Descriptions and Functionality	7
2.1	HDMI® Port	7
2.2	USB 2.0 Port	7
2.3	10/100Mbps Ethernet Ports	8
2.4	Micro USB 2.0 Port	8
2.5	Headphone Jack	9
2.6	Reset Button	9
2.7	Power Button	9
3.	Onboard I/O	10
3.1	MiniPCIe Slot	10
3.2	SIM Card Slot	11
3.3	COM Connectors	12
3.4	Battery Charger Connector	13
3.5	DC-in Connector	13
3.6	MIPI CSI-2 Connector	14
3.7	MIPI DSI Connector	15
3.8	Touch Screen Connector	16
3.9	Mono Speaker-out Connector	17
3.10	MCU Firmware Pin Header	17
3.11	I ² C/SPI/GPIO Pin Header	18
3.12	Volume Buttons	19
3.13	IPEX Connectors	19
4.	Onboard Jumpers	20
4.1	OS Image Jumpers	21
4.2	Watchdog Jumper	21
5.	Hardware Installation	22
5.1	Installing into a Chassis	22
5.1.1	Suggested Minimum Chassis Dimensions	22
5.1.2	Suggested Minimum Chassis Height	23
5.1.3	Suggested Keepout Areas	23
6.	Software and Technical Support	24
6.1	Android and Yocto Support	24
6.2	Technical Support and Assistance	24
	Appendix A. FX8-100S-SV Connectors	25
A.1.	FX8-100S-SV Connectors Pinouts	25
A.2.	FX8-100S-SV Connectors Placement	27
	Appendix B. Installing Wireless Accessories	28
B.1.	Installing the VIA EMIO-2574 Mobile Broadband Module	28
	Appendix C. Connecting LCD Display	30
C.1.	Connecting the 10.1" TFT-LCD Display	30

List of Figures

Figure 1:	Layout diagram of the VIA VAB-950 (top side)	4
Figure 2:	Layout diagram of the VIA VAB-950 front panel I/O	4
Figure 3:	Layout diagram of the VIA VAB-950 back panel I/O	4
Figure 4:	Layout diagram of the VIA VAB-950 right panel I/O	4
Figure 5:	Dimensions of the VIA VAB-950 (top view)	5
Figure 6:	External I/O dimensions of the VIA VAB-950 (front panel)	5
Figure 7:	External I/O dimensions of the VIA VAB-950 (back panel)	5
Figure 8:	External I/O dimensions of the VIA VAB-950 (right panel)	5
Figure 9:	Height distribution of the VIA VAB-950 (top side)	6
Figure 10:	HDMI port diagram	7
Figure 11:	USB 2.0 port diagram	7
Figure 12:	10/100Mbps Ethernet port diagram	8
Figure 13:	Micro USB 2.0 port diagram	8
Figure 14:	Headphone jack diagram	9
Figure 15:	Reset button diagram	9
Figure 16:	Power button diagram	9
Figure 17:	MiniPCIe slot diagram	10
Figure 18:	SIM card slot diagram	11
Figure 19:	COM connectors diagram	12
Figure 20:	Battery charger connector diagram	13
Figure 21:	DC-in connector diagram	13
Figure 22:	MIPI CSI-2 connector diagram	14
Figure 23:	MIPI DSI connector diagram	15
Figure 24:	Touch screen connector diagram	16
Figure 25:	Mono speaker-out connector diagram	17
Figure 26:	MCU firmware pin header diagram	17
Figure 27:	I ² C/SPI/GPIO pin header diagram	18
Figure 28:	Volume buttons diagram	19
Figure 29:	IPEX connectors diagram	19
Figure 30:	Jumper settings example	20
Figure 31:	OS image jumpers diagram	21
Figure 32:	Watchdog jumper diagram	21
Figure 33:	Suggested minimum chassis dimensions	22
Figure 34:	Suggested minimum chassis height	23
Figure 35:	Suggested keepout areas	23
Figure 36:	FX8-100S-SV connectors diagram	25
Figure 37:	FX8-100S-SV connectors placement	27
Figure 38:	Installing the VIA EMIO-2574 module	28
Figure 39:	Securing the VIA EMIO-2574 module	28
Figure 40:	Installing the 4G antenna cable and antenna	29
Figure 41:	Connecting the 4G antenna cable to VIA EMIO-2574 module	29
Figure 42:	Connecting 34-pin FFC cable to the 10.1" TFT-LCD display	30
Figure 43:	Connecting 8-pin FFC cable to the 10.1" TFT-LCD display	31

List of Tables

Table 1:	HDMI port pinouts	7
Table 2:	USB 2.0 port pinouts	7
Table 3:	10/100Mbps Ethernet ports pinouts	8
Table 4:	10/100Mbps Ethernet port LED color definition.....	8
Table 5:	Micro USB 2.0 port pinouts.....	8
Table 6:	Power button behavior description	9
Table 7:	MiniPCIe slot pinouts	10
Table 8:	SIM card slot pinouts	11
Table 9:	COM connectors pinouts.....	12
Table 10:	Battery charger connector pinouts	13
Table 11:	DC-in connector pinouts	13
Table 12:	MIPI CSI-2 connector pinouts.....	14
Table 13:	MIPI DSI connector pinouts.....	15
Table 14:	Touch screen connector pinouts	16
Table 15:	Mono speaker-out connector pinouts	17
Table 16:	MCU firmware pin header pinouts.....	17
Table 17:	I ² C/SPI/GPIO pin header pinouts.....	18
Table 18:	OS image jumpers settings	21
Table 19:	Watchdog jumper settings	21
Table 20:	FX8-100S-SV connectors pinouts	26

1. Product Overview

Accelerate your time-to-market for groundbreaking Edge AI devices with the VIA VAB-950. Powered by the high-performance, power-efficient MediaTek i500 AIoT platform, the board combines advanced AI technology for display, object recognition, and voice with rich wireless and I/O connectivity features.

The VIA VAB-950's multimedia capabilities include hardware-accelerated H.265/H.264 Full HD video decoding and support for MIPI displays and cameras – making it the ideal solution for an unlimited array of home, commercial, industrial, and educational applications and use cases.

The VIA VAB-950 harnesses the power of the MediaTek i500 AIoT platform to deliver blistering edge processing and multimedia performance. In addition to quad-core ARM Cortex-A73 and quad-core Cortex-A53 processors, the i500 platform also features an integrated AI processor for deep learning, neural network acceleration, and computer vision applications, including facial recognition, object identification, and OCR.

Based on the EPIC 14cm x 10cm form factor, the VIA VAB-950 offers a wealth of connectivity options, including an integrated SIM card slot for LTE/4G, dual-band 802.11ac Wi-Fi, two 10/100Mbps Ethernet ports, and Bluetooth 5.0. The board also features one USB 2.0 port and one Micro USB 2.0 client port, as well as HDMI, MIPI DSI and MIPI CSI-2 display and camera support with multi-function pins for I²C, SPI and GPIO connectivity. Onboard storage is provided by 16GB eMMC flash memory.

1.1 Key Features

- High-performance octa-core MediateK i500 processor
- Integrated AI processor for AIoT applications
- Full HD hardware accelerated H.265/H.264 video decoding
- Dual-band 802.11ac Wi-Fi with Bluetooth 5.0, plus onboard SIM card slot
- 16GB onboard eMMC Flash memory
- MIPI DSI display, and MIPI CSI-2 camera support
- Supports up to twelve GPIO devices
- Supports Android 10 and Yocto 2.6 operating systems
- Fanless and low power consumption

1.2 Product Specifications

Processor

- MediaTek i500 octa-core Processor
 - Four Cortex-A73 @ 2.0GHz
 - Four Cortex-A53 @ 2.0GHz

System Memory

- 2GB LPDDR4 SDRAM (VAB-950-V2)
- 4GB LPDDR4 SDRAM (VAB-950-V4)

Storage

- 16GB eMMC Flash Memory

Graphics

- ARM Mali-G72 high-performance GPU
 - 3D graphics accelerator capable of processing 2400M pixel/sec @ 800MHz
 - Graphics engine supporting OpenGL® ES 3.0, OpenCL ES 1.1, and Vulkan 1.0 hardware acceleration
 - Supports H.265 and H.264 video decoding up to 1080p@30fps Supports Cadence Tensilica Vision P6 x2 DSP

Wireless Connectivity

- MediaTek MT7668
 - 2x2 Dual-band Wi-Fi 802.11ac with MU-MIMO
 - Bluetooth 5.0

Audio

- MediaTek MT6358

HDMI

- ITE IT66121FN Digital Parallel Interface to HDMI 1.3a transmitter

USB

- TI TS3USB21 High-speed USB 2.0 (480Mbps) 1:2 Multiplexer/Demultiplexer Switch with Single Enable
- Microchip LAN9514 USB 2.0 to USB hub and 10/100Mbps Ethernet controller

LAN

- ASIX AX88772 USB 2.0 to Fast Ethernet controller

Onboard I/O

- 1 COM port (supports RS-232 TX/RX)
- 1 Debug port (supports RS-232 TX/RX)
- 1 JTAG connector
- 1 MIPI DSI connector
- 1 MIPI CSI-2 connector
- 1 Touch screen connector (includes I²C for capacitive touch)
- 1 SIM card slot
- 1 MiniPCIe slot (supports USB 2.0 connectivity for optional 4G module)
- 2 Volume buttons
- 1 Mono speaker-out connector
- 1 Miscellaneous pin header (for 1 I²C pair, 1 SPI and 12 GPIOs)
- 1 Battery charger connector (supports I²C and Gas gauge)
- 3 IPEX connectors (for Wi-Fi and Bluetooth antennas)
- 1 12V DC-in connector

Front Panel I/O

- 1 Power button with LED
- 1 Reset button

Back Panel I/O

- 1 HDMI port
- 1 USB 2.0 port
- 1 Micro USB 2.0 port (for OS image upload only)
- 2 10/100Mbps Ethernet ports

Right Panel I/O

- 1 Audio jack (supports Headphone and Mic-in)

Power Supply

- 12V DC-in

Operating System

- Android 10
- Yocto 2.6

Operating Temperature

- 0°C ~ 60°C

Operating Humidity

- 0% ~ 95% (relative humidity; non-condensing)

Form Factor

- EPIC, 14cm x 10cm (140mm x 100mm, 5.51" x 3.94")

**Notes:**

1. As the operating temperature provided in the specifications is a result of testing performed in a testing chamber, a number of variables can influence this result. Please note that the working temperature may vary depending on the actual situation and environment. It is highly recommended to execute a solid testing program and take all variables into consideration when building the system. Please ensure that the system is stable under at the required operating temperature in terms of application.
2. Please note that the lifespan of the onboard eMMC memory chip may vary depending on the amount of access. More frequent and larger data access on the eMMC memory makes its lifespan shorter. Therefore, it is highly recommended to use a replaceable external storage (e.g., Micro SD card) for large data access.

1.3 Layout Diagram

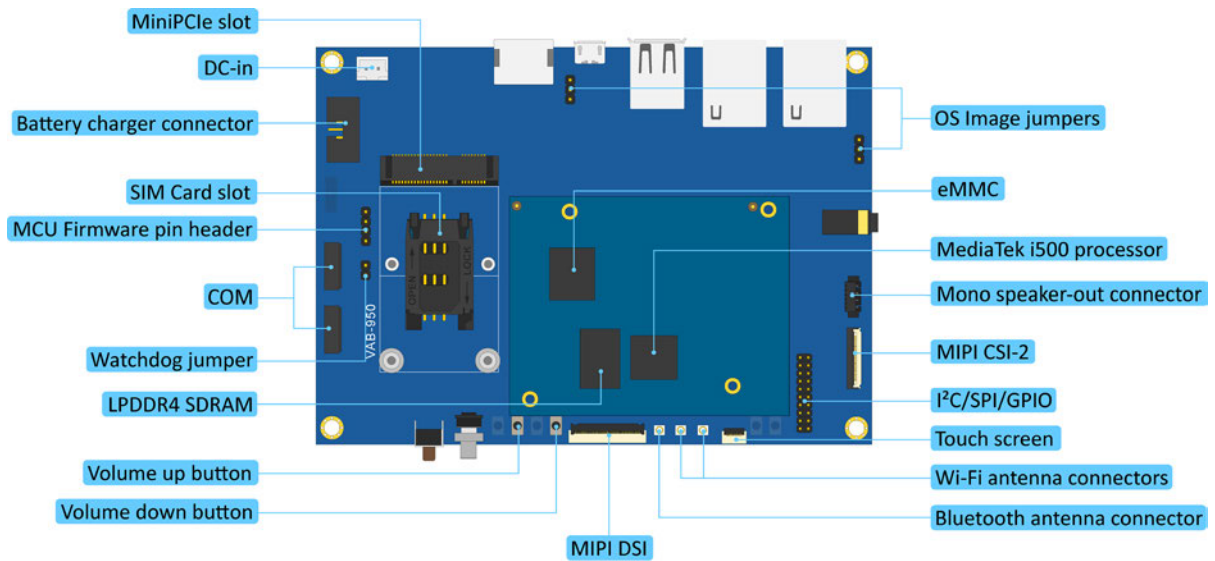

Figure 1: Layout diagram of the VIA VAB-950 (top side)

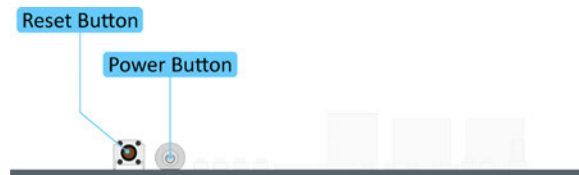

Figure 2: Layout diagram of the VIA VAB-950 front panel I/O

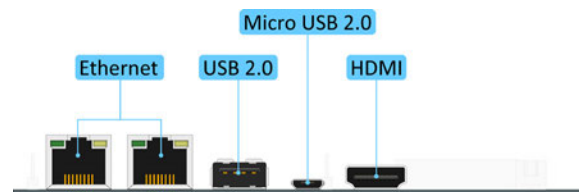

Figure 3: Layout diagram of the VIA VAB-950 back panel I/O



Figure 4: Layout diagram of the VIA VAB-950 right panel I/O

1.4 Product Dimensions

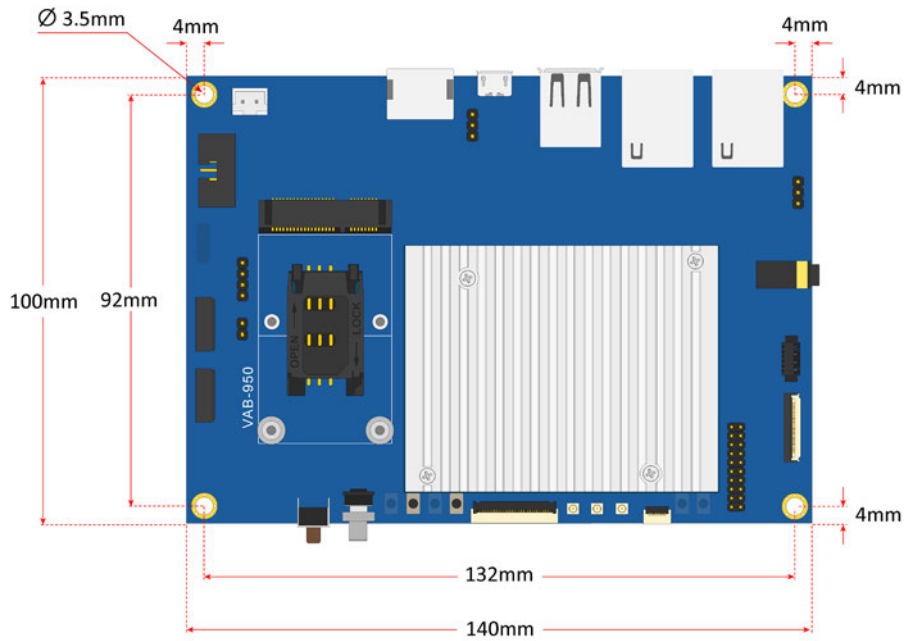

Figure 5: Dimensions of the VIA VAB-950 (top view)

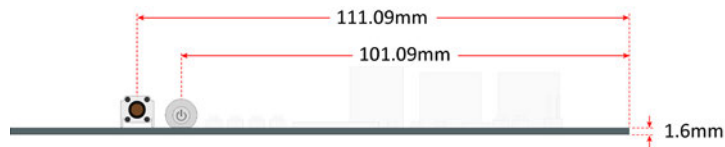

Figure 6: External I/O dimensions of the VIA VAB-950 (front panel)

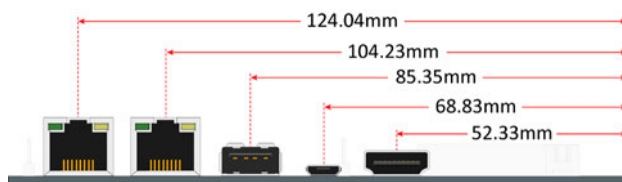

Figure 7: External I/O dimensions of the VIA VAB-950 (back panel)



Figure 8: External I/O dimensions of the VIA VAB-950 (right panel)

1.5 Height Distribution

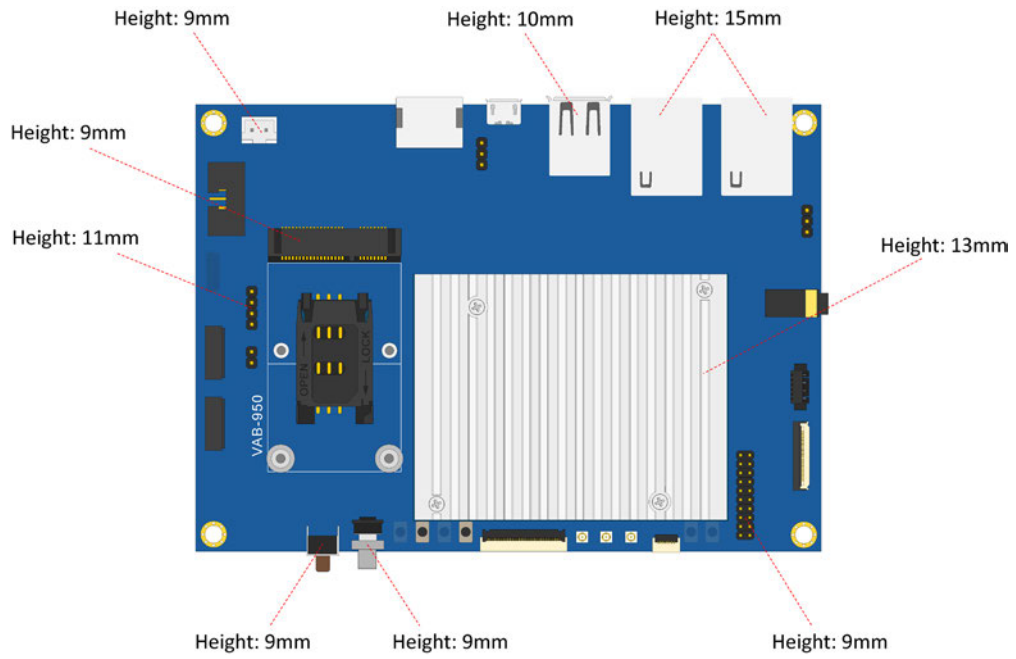

Figure 9: Height distribution of the VIA VAB-950 (top side)

2. External I/O Pin Descriptions and Functionality

The VIA VAB-950 has a wide selection of interfaces, and includes a selection of frequently-used ports as part of the external I/O coastline.

2.1 HDMI® Port

The VIA VAB-950 is equipped with one HDMI port on the back panel which uses an HDMI port Type A receptacle connector to connect High Definition video and digital audio using a single cable. The pinouts of the HDMI port are shown below.

Pin	Signal	Pin	Signal
1	D2+	11	GND
2	GND	12	CLK-
3	D2-	13	CEC
4	D1+	14	NC
5	GND	15	DDC_CLK
6	D1-	16	DDC_DATA
7	D0+	17	GND
8	GND	18	HDMI_5V
9	D0-	19	PLUG_DET
10	CLK+		



Figure 10: HDMI port diagram

Table 1: HDMI port pinouts

2.2 USB 2.0 Port

The VIA VAB-950 is equipped with a USB 2.0 port on the back panel. The USB 2.0 port provides complete Plug and Play and hot swap capabilities for external devices. The pinouts of the USB 2.0 port are shown below.

Pin	Signal
1	VCC
2	USB data -
3	USB data+
4	GND

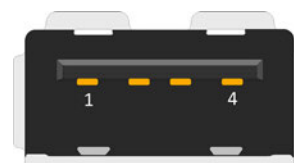

Figure 11: USB 2.0 port diagram

Table 2: USB 2.0 port pinouts

2.3 10/100Mbps Ethernet Ports

The VIA VAB-950 comes with two 10/100Mbps Ethernet ports on the back panel. Each 10/100Mbps Ethernet port uses an 8 Position and 8 Contact (8P8C) receptacle connector commonly known as RJ-45, which is fully compliant with the IEEE 802.3 (10BASE-T) and 802.3u (100BASE-TX) standards. The pinouts of the 10/100Mbps Ethernet ports are shown below.

LAN1		LAN2	
Pin	Signal	Pin	Signal
1	TD+	1	TD+
2	TD-	2	TD-
3	RD+	3	RD+
4	REGOUT	4	REGOUT
5	REGOUT	5	REGOUT
6	RD-	6	RD-
7	GND	7	GND
8	GND	8	GND

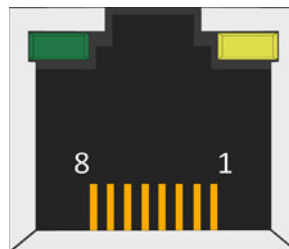

Figure 12: 10/100Mbps Ethernet port diagram

Table 3: 10/100Mbps Ethernet ports pinouts

Each 10/100Mbps Ethernet port has two individual LED indicators located on the front side to show its Active/Link status and Speed status.

	Link LED (Left LED on RJ-45 port)	Active LED (Right LED on RJ-45 port)
Link off	LED is off	LED is off
Speed_10Mbit	LED is off	Orange flash
Speed_100Mbit	Green is on	Orange flash

Table 4: 10/100Mbps Ethernet port LED color definition

2.4 Micro USB 2.0 Port

The VIA VAB-950 is equipped with a Micro USB 2.0 port on the back panel. The Micro USB 2.0 port is used for downloading the OS image. The pinouts of the Micro USB 2.0 port are shown below.

Pin	Signal
1	VBUS
2	D-
3	D+
4	ID
5	GND



Figure 13: Micro USB 2.0 port diagram

Table 5: Micro USB 2.0 port pinouts

2.5 Headphone Jack

The VIA VAB-950 comes with a 3.5mm headphone jack located on the right side panel. The headphone jack is used for connecting to external speakers or headphones. The diagram of the headphone jack is shown below.



Figure 14: Headphone jack diagram

2.6 Reset Button

The VIA VAB-950 comes with a reset button on the front panel which allows the user to reboot or reset the system forcibly. The diagram of the reset button is shown below.

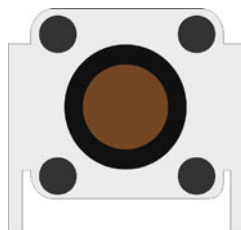

Figure 15: Reset button diagram

2.7 Power Button

The VIA VAB-950 comes with a power button featuring a built-in power LED indicator (green light). The power button can support two functions: Power On/Off and System Suspend/Resume. The diagram of the power button is shown below.



Figure 16: Power button diagram

Power Button behavior	
Power On/Off	Quickly press the button once to power on. To power off, press the button for more than 4 seconds.
System Suspend/Resume	Quickly press the power button once to suspend. While in suspend mode quickly press once to resume.

Table 6: Power button behavior description

3. Onboard I/O

This chapter provides information about the onboard I/O connectors and pin headers of the VIA VAB-950.

3.1 MiniPCle Slot

The VIA VAB-950 is equipped with a miniPCle slot labeled as 'MINIPCI1' for wireless networking options such as a 4G module. The pinouts of the miniPCle slot are shown below.

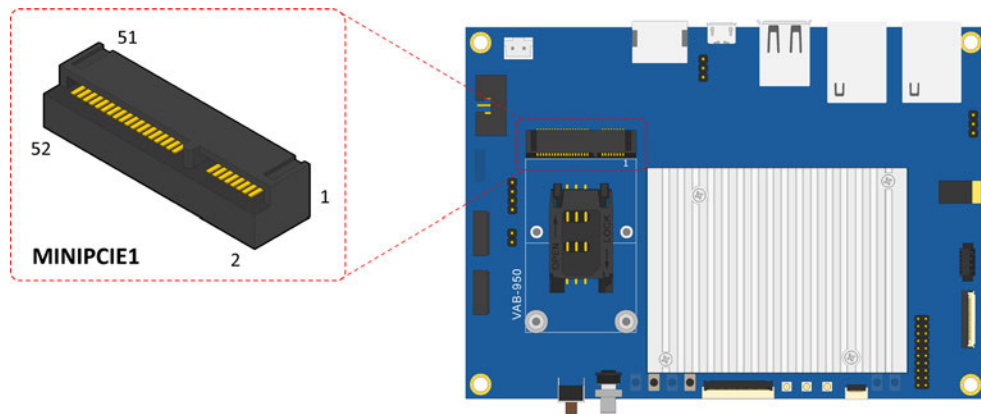

Figure 17: MiniPCle slot diagram

Pin	Signal	Pin	Signal	Pin	Signal	Pin	Signal
1	Reserved	2	VDD3V3_MPCIE	27	GND	28	VDD1V5
3	Reserved	4	GND	29	GND	30	Reserved
5	Reserved	6	VDD1V5	31	Reserved	32	Reserved
7	Reserved	8	USIM_VCC	33	Reserved	34	GND
9	GND	10	USIM_DATA	35	GND	36	MINI_PCIE_USB_DM
11	Reserved	12	USIM_CLK	37	GND	38	MINI_PCIE_USB_DM
13	Reserved	14	USIM_RST	39	VDD3V3_MPCIE	40	GND
15	GND	16	USIM_VPP	41	VDD3V3_MPCIE	42	Reserved
17	Reserved	18	GND	43	GND	44	Reserved
19	Reserved	20	MPCIE_W_DISABLE	45	Reserved	46	Reserved
21	GND	22	MPCIE_RST_N	47	Reserved	48	VDD1V5
23	Reserved	24	VDD3V3_MPCIE	49	Reserved	50	GND
25	Reserved	26	GND	51	Reserved	52	VDD3V3_MPCIE

Table 7: MiniPCle slot pinouts

3.2 SIM Card Slot

The VIA VAB-950 comes with a SIM card slot that supports 4G SIM cards. SIM card usage on the VIA VAB-950 requires that a 4G module is installed in the miniPCIe slot, enabling the 4G functionality, otherwise the SIM card slot will be disabled. The SIM card slot is designed for use with 4G modules that do not support built-in SIM card slots. The pinouts of the SIM card slot are shown below.

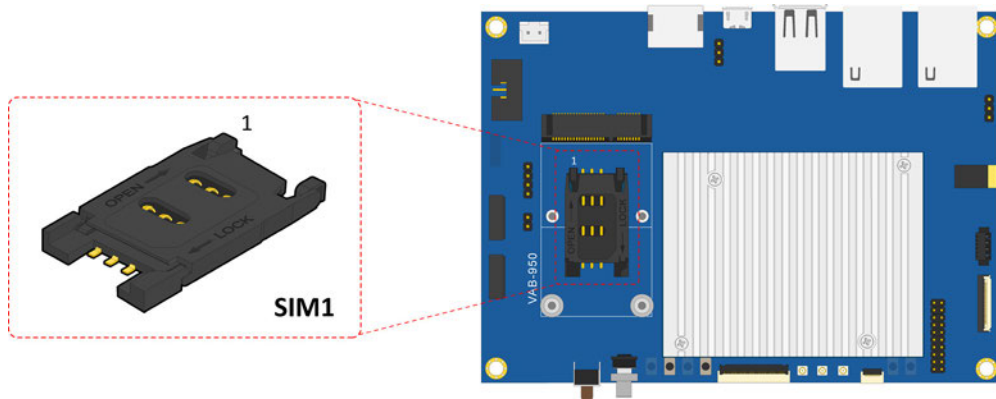

Figure 18: SIM card slot diagram

Pin	Signal
1	USIM_VCC_A
2	USIM_RST_A
3	USIM_CLK_A
4	NC
5	GND
6	USIM_VPPSIM_A
7	USIM_DATA_A

Table 8: SIM card slot pinouts

3.3 COM Connectors

The VIA VAB-950 is equipped with two COM connectors labeled as 'COM' and COM1'. The 'COM' connector is used for debugging while the 'COM1' connector supports RS-232 mode (TX/RX). The pinouts of the COM connectors are shown below.

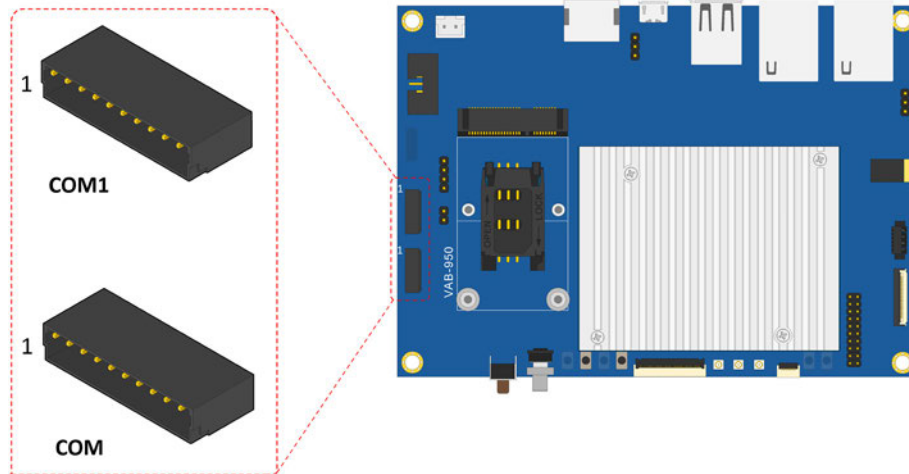

Figure 19: COM connectors diagram

COM		COM1	
Pin	Signal	Pin	Signal
1	NC	1	NC
2	COM_RXD0	2	COM_RXD1
3	COM_TXD0	3	COM_TXD1
4	NC	4	NC
5	NC	5	NC
6	GND	6	GND
7	NC	7	NC
8	NC	8	NC
9	NC	9	NC
10	NC	10	NC

Table 9: COM connectors pinouts

3.4 Battery Charger Connector

The VIA VAB-950 is equipped with a battery charger connector labeled as 'BAT1' which is used for charging the rechargeable lithium battery. The pinouts of the battery charger connector are shown below.

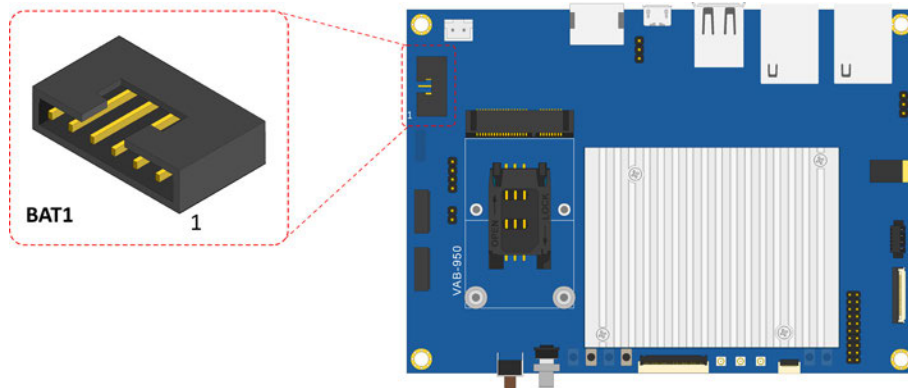

Figure 20: Battery charger connector diagram

Pin	Signal
1	BAT+
2	BAT+
3	I2C_CLK
4	I2C_DATA
5	TH
6	BAT-
7	BAT-

Table 10: Battery charger connector pinouts

3.5 DC-in Connector

The VIA VAB-950 comes with a DC-in connector that carries a 12V DC which provides power to the board. The DC-in connector is labeled as 'J3'. The pinouts of the DC-in connector are shown below.

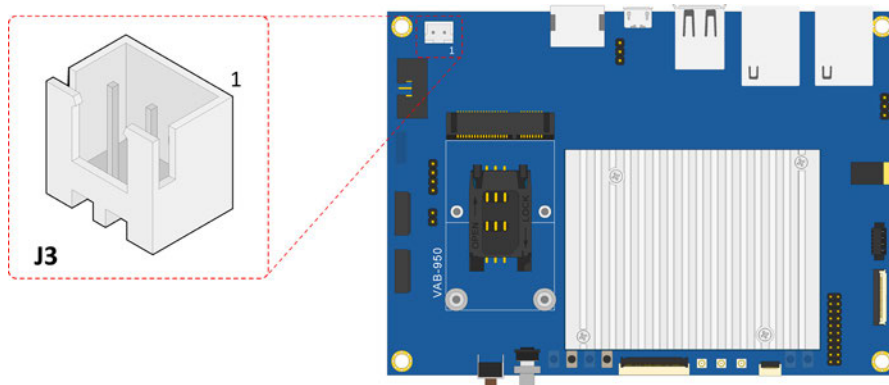

Figure 21: DC-in connector diagram

Pin	Signal
1	12VIN
2	GND

Table 11: DC-in connector pinouts

3.6 MIPI CSI-2 Connector

The VIA VAB-950 is equipped with a MIPI CSI-2 connector labeled as 'JCSI' which is used for connecting the CSI camera. The pinouts of the MIPI CSI-2 connector are shown below.

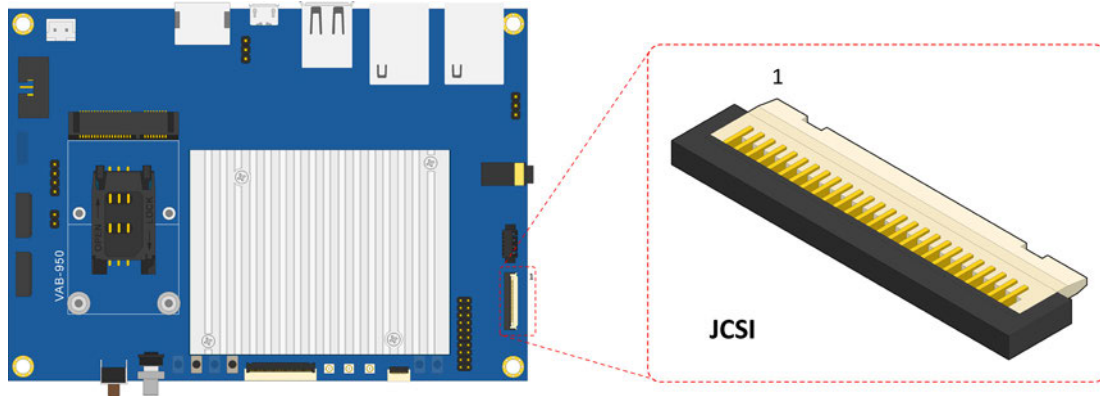

Figure 22: MIPI CSI-2 connector diagram

Pin	Signal	Pin	Signal
1	RDPO	14	CLKN
2	RDNO	15	GND
3	GND	16	CLK of sensor
4	RDP1_B	17	PDN
5	RDN1_B	18	Reset
6	GND	19	I2C_DATA
7	NC	20	I2C_CLK
8	NC	21	1.8V
9	GND	22	1.5V
10	NC	23	2.8V
11	NC	24	2.8V
12	GND	25	GND
13	CLKP	26	GND

Table 12: MIPI CSI-2 connector pinouts

3.7 MIPI DSI Connector

The VIA VAB-950 is equipped with a MIPI DSI connector labeled as 'JDSI' which is used for connecting the LCD display. The pinouts of the MIPI DSI connector are shown below.

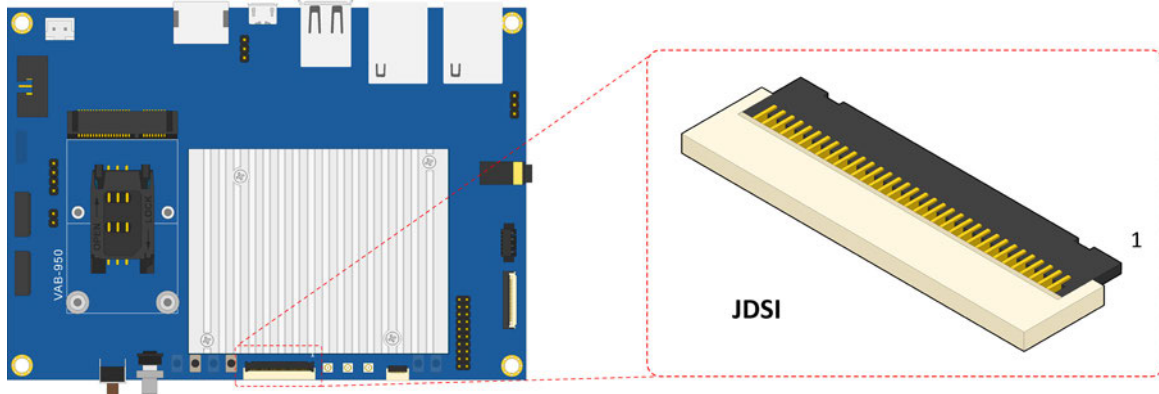

Figure 23: MIPI DSI connector diagram

Pin	Signal	Pin	Signal
1	3.3V	18	GND
2	3.3V	19	DSI_D0P
3	NC	20	DSI_D0N
4	LCD VDDEN	21	GND
5	Backlight_PWM	22	DSI_D3P
6	I2C_DATA	23	DSI_D3N
7	I2C_CLK	24	GND
8	NC	25	GND
9	GND	26	GND
10	DSI_D2P	27	GND
11	DSI_D2N	28	NC
12	GND	29	AGING
13	DSI_D1P	30	NC
14	DSI_D1N	31	Backlight power
15	GND	32	Backlight power
16	DSI_CKP	33	Backlight power
17	DSI_CKN	34	Backlight power

Table 13: MIPI DSI connector pinouts

3.8 Touch Screen Connector

The VIA VAB-950 is equipped with a touch screen connector labeled as 'JTOUCH' which is used for connecting the touch screen controller. The pinouts of the touch screen connector are shown below.

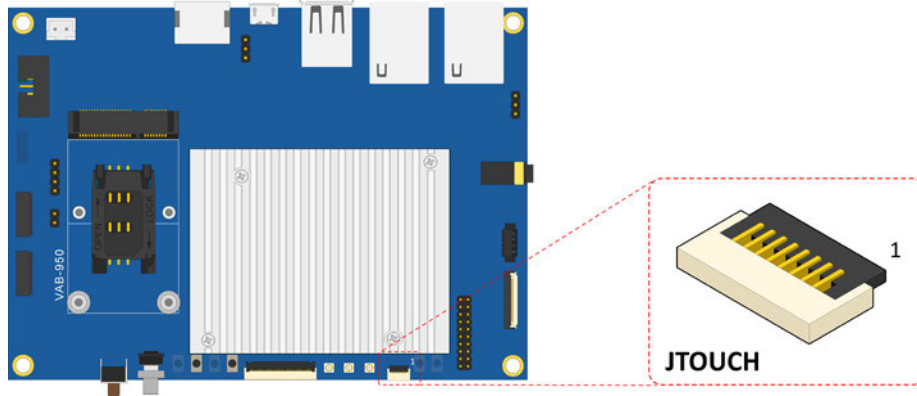

Figure 24: Touch screen connector diagram

Pin	Signal
1	GND
2	NC
3	NC
4	Interrupt
5	I2C_CLK
6	I2C_DATA
7	3.3V
8	Reserved

Table 14: Touch screen connector pinouts

3.9 Mono Speaker-out Connector

The VIA VAB-950 is equipped with a mono speaker-out connector labeled as 'J10' which is used for connecting the mono speaker. The pinouts of the mono speaker-out connector are shown below.

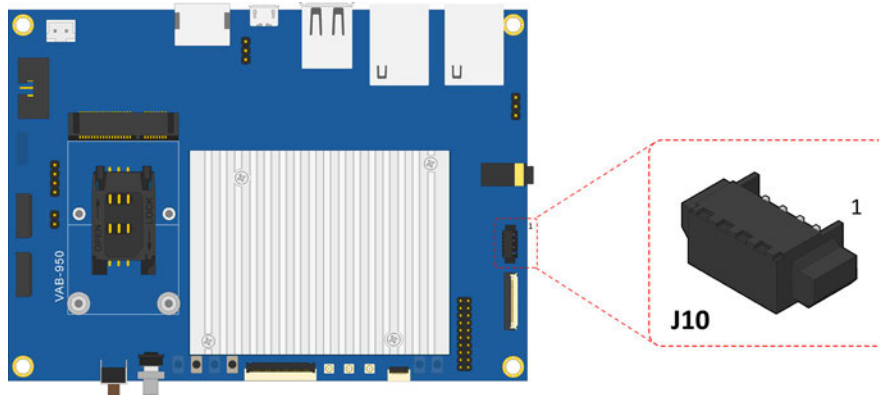

Figure 25: Mono speaker-out connector diagram

Pin	Signal
1	OutLN
2	OutLP
3	OutRN
4	OutRP

Table 15: Mono speaker-out connector pinouts

3.10 MCU Firmware Pin Header

The VIA VAB-950 is equipped with an MCU firmware pin header which is used for flashing the MCU firmware on the Management IC. The MCU firmware pin header is labeled as 'J14'. The pinouts of the MCU firmware pin header are shown below.

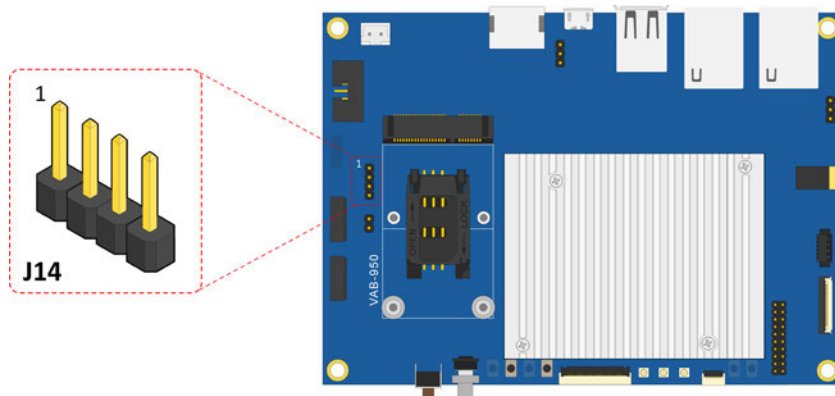

Figure 26: MCU firmware pin header diagram

Pin	Signal
1	3.3V
2	DATA
3	CLK
4	GND

Table 16: MCU firmware pin header pinouts

3.11 I²C/SPI/GPIO Pin Header

The VIA VAB-950 comes with an I²C/SPI/GPIO pin header labeled as 'J1' which is used for connecting the I²C, SPI, and 12 GPIO devices. The pinouts of the I²C/SPI/GPIO pin header are shown below.

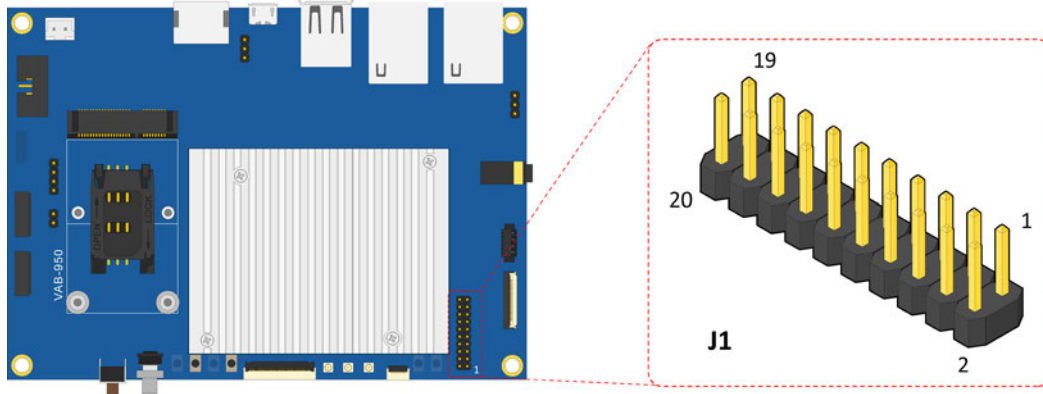

Figure 27: I²C/SPI/GPIO pin header diagram

Pin	Signal	Pin	Signal
1	SPI_CLK	2	SPI_CS
3	SPI_MISO	4	SPI_MOSI
5	GPIO79	6	GPIO53
7	GPIO80	8	GPIO54
9	GPIO52	10	GPIO78
11	GPIO77	12	GPIO57
13	I2C_CLK1	14	GPIO56
15	I2C_DATA1	16	GPIO55
17	GND	18	GPIO69
19	1.8V	20	GPIO70

Table 17: I²C/SPI/GPIO pin header pinouts

3.12 Volume Buttons

The VIA VAB-950 comes with two volume buttons which are used to control the volume. The volume up and volume down buttons are labeled as 'SW3' and 'SW5' respectively. The diagram of the volume buttons is shown below.

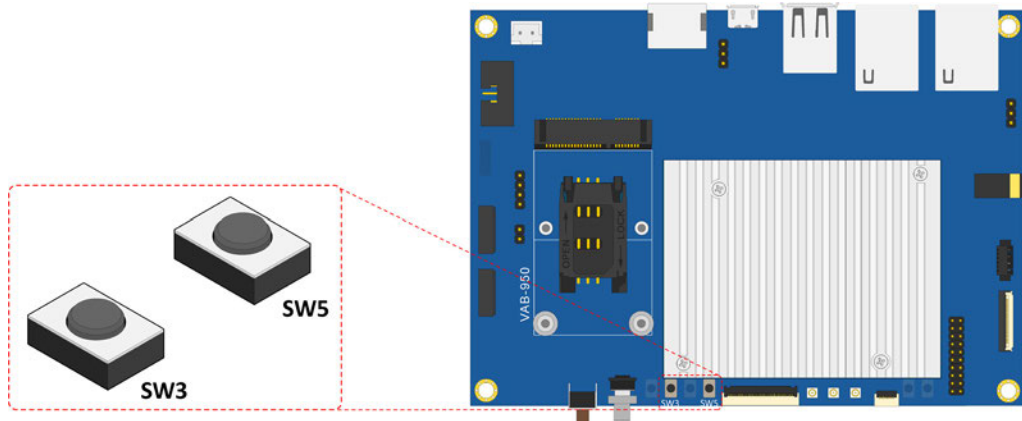

Figure 28: Volume buttons diagram

3.13 IPEX Connectors

The VIA VAB-950 comes with three IPEX connectors labeled 'CON1', 'CON2' and 'CON3' which are used for connecting the Bluetooth and Wi-Fi antennas. The connector labeled 'CON2' is for Bluetooth antenna while the connectors labeled 'CON1' and 'CON3' are for Wi-Fi antennas. The diagram of the IPEX connectors is shown below.

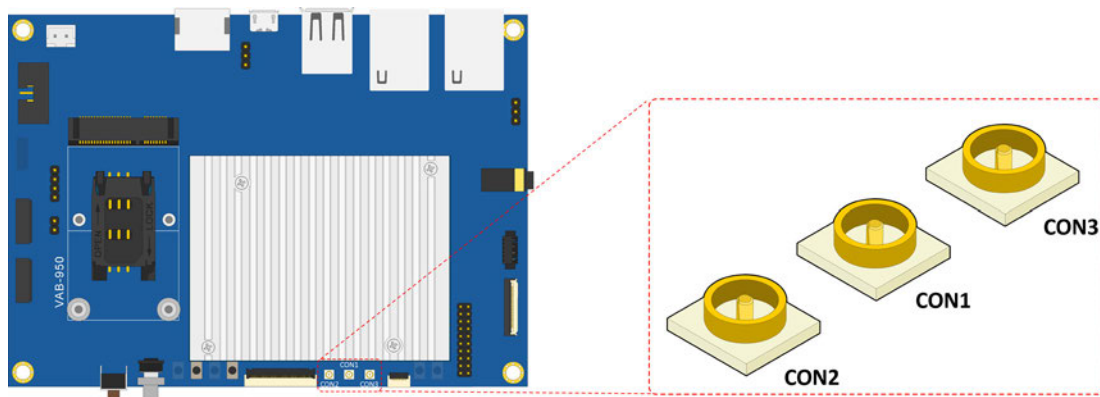

Figure 29: IPEX connectors diagram

4. Onboard Jumpers

Jumper Description

A jumper consists of a pair of conductive pins used to close in or bypass an electronic circuit to set up or configure a particular feature using a jumper cap. The jumper cap is a small metal clip covered by plastic. It performs like a connecting bridge to short (connect) the pair of pins. The usual colors of the jumper cap are black/red/blue/white/yellow.

Jumper Setting

There are two settings of the jumper pin: 'Short' and 'Open'. The pins are 'Short' when a jumper cap is placed on the pair of pins. The pins are 'Open' if the jumper cap is removed.

In addition, there are jumpers that have three or more pins, and some pins are arranged in series. In case of a jumper with three pins, place the jumper cap on pin 1 and pin 2 or pin 2 and 3 to Short it.

Some jumpers size are small or mounted on a crowded location on the board that makes it difficult to access. Therefore, using a long-nose plier in installing and removing the jumper cap is very helpful.

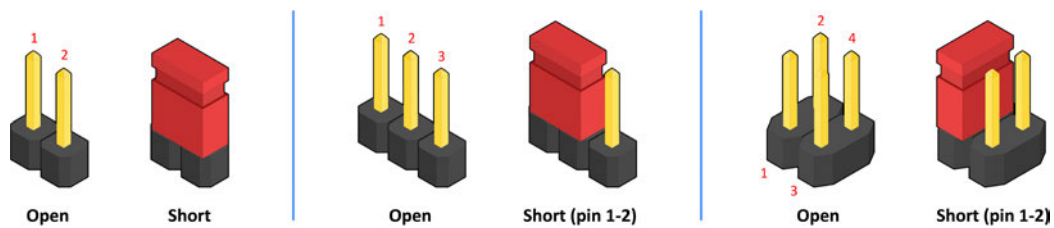

Figure 30: Jumper settings example



Caution:

Make sure to install the jumper cap on the correct pins. Installing it on the wrong pins might cause damage and malfunction.

4.1 OS Image Jumpers

The VIA VAB-950 comes with two OS image jumpers labeled as 'J5' and 'J7'. The OS image jumpers are used to set the Micro USB 2.0 port to a download mode for the OS image download. The OS image jumper settings are shown below.

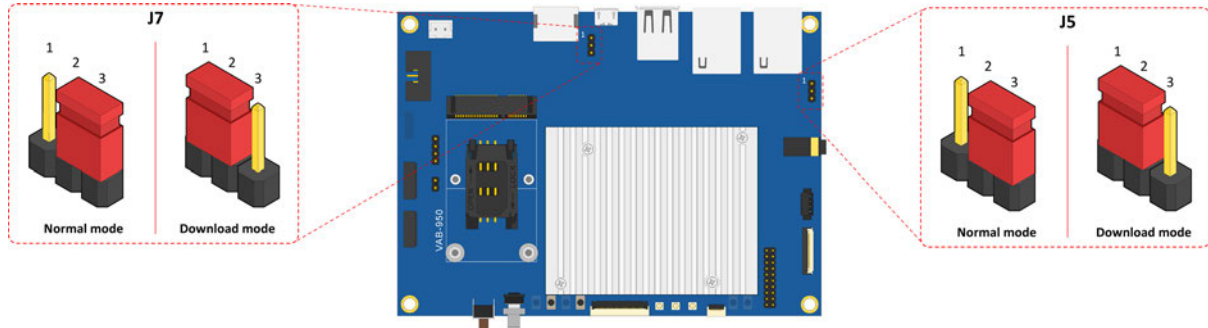

Figure 31: OS image jumper diagram

J5 and J7 Settings	Pin 1	Pin 2	Pin 3
Normal mode (default)	Open	Short	Short
Download mode	Short	Short	Open

Table 18: OS image jumper settings

4.2 Watchdog Jumper

The VIA VAB-950 comes with a watchdog jumper labeled as 'J15'. The watchdog jumper is used to enable or disable the watchdog function on the board. The watchdog jumper settings are shown below.

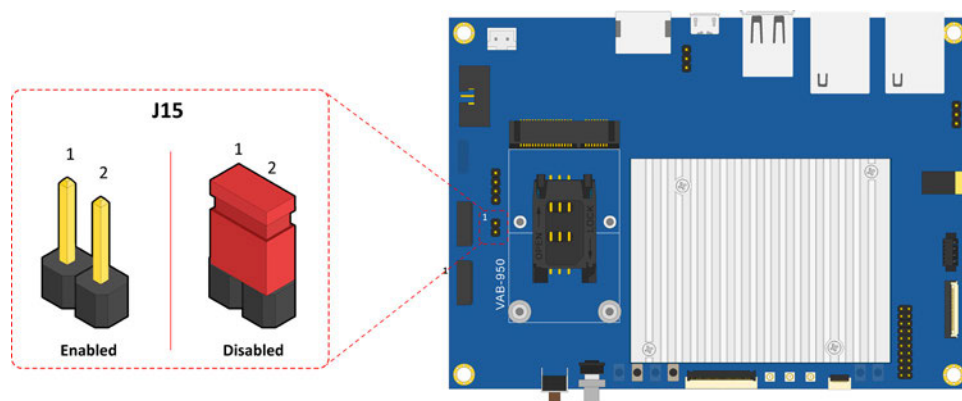

Figure 32: Watchdog jumper diagram

Settings	Pin 1	Pin 2
Enabled (default)	Open	Open
Disabled	Short	Short

Table 19: Watchdog jumper settings

5. Hardware Installation

5.1 Installing into a Chassis

The VIA VAB-950 can be fitted into any chassis that has mounting holes compatible with the standard SBC mounting hole locations. Additionally, the chassis must meet the minimum height requirements for specified areas of the board.

5.1.1 Suggested Minimum Chassis Dimensions

The figure below shows the suggested minimum space requirements that a chassis should have in order to work well with the VIA VAB-950.

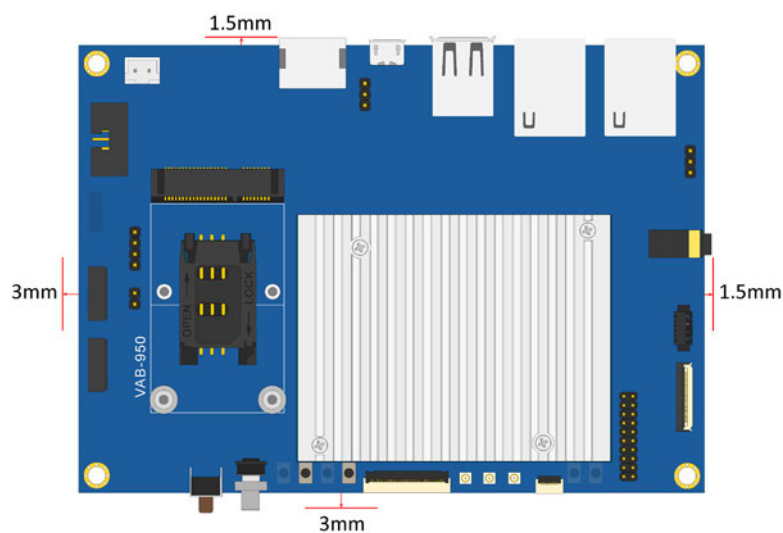

Figure 33: Suggested minimum chassis dimensions

Each side of the board should have a buffer zone from the internal wall of the chassis. The side of the board that accommodates the I/O coastline should have a buffer of 1.5mm; it's comprised of one HDMI port, one Micro USB 2.0 port, one USB 2.0 port, and two 10/100Mbps Ethernet ports. The side on the opposite end of the I/O coastline should have a buffer of at least 3mm. The right side of the I/O coastline should have a buffer of 1.5mm and it's only comprised of a headphone jack. The left side of the I/O coastline should have a buffer of at least 3mm.

5.1.2 Suggested Minimum Chassis Height

The figure below shows the suggested minimum height requirements for the internal space of the chassis. It is not necessary for the internal ceiling to be evenly flat. What is required is that the internal ceiling height must be strictly observed for each section that is highlighted.

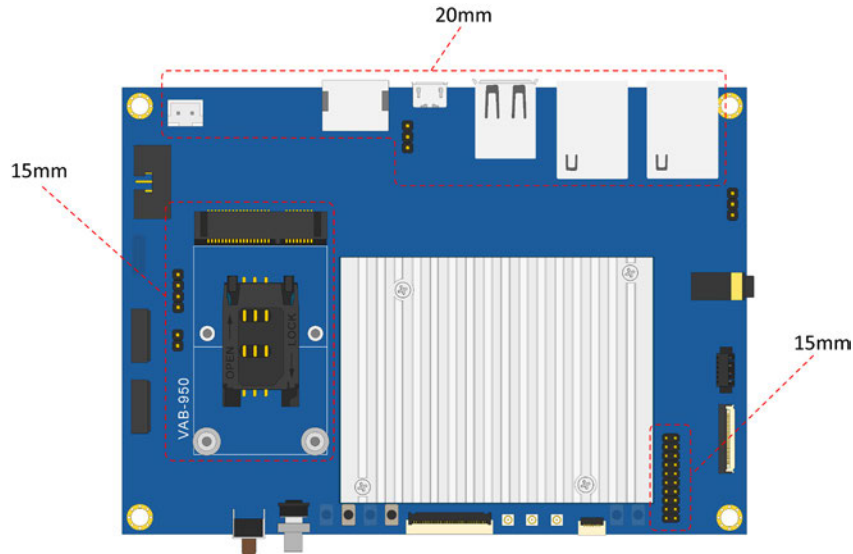

Figure 34: Suggested minimum chassis height

5.1.3 Suggested Keepout Areas

The figure below shows the areas of the board that we recommend should be left unobstructed. The figure below is the top view.

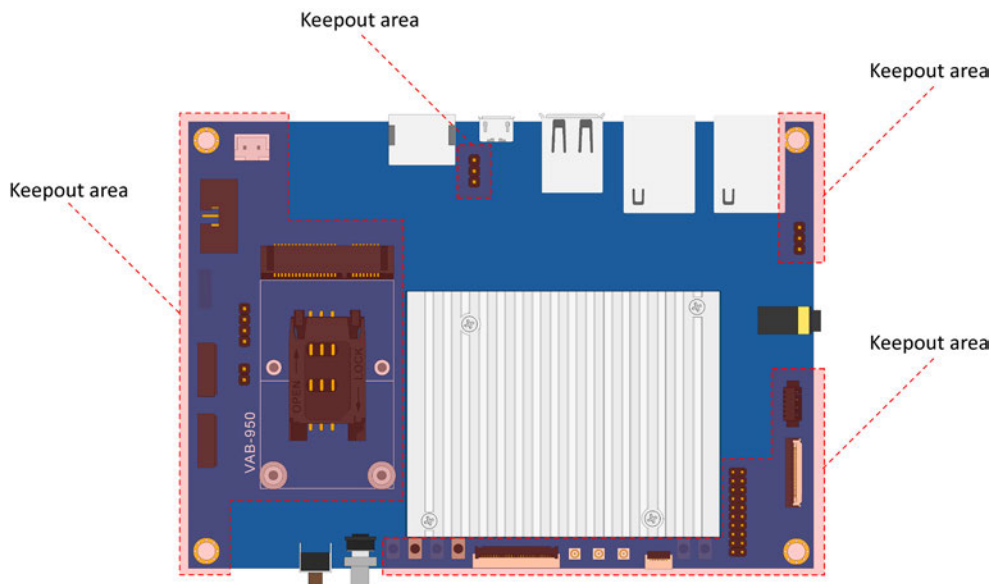

Figure 35: Suggested keepout areas

6. Software and Technical Support

6.1 Android and Yocto Support

The VIA VAB-950 features a complete software evaluation image featuring the Android 10 and Yocto 2.6 operating systems.

6.2 Technical Support and Assistance

- For utilities downloads and the latest documentation and information about the VIA VAB-950, please visit our website at <https://www.viatech.com/en/products/boards/embedded-boards/vab-950/>
- For technical support and additional assistance, always contact your local sales representative or board distributor, or go to <https://www.viatech.com/en/support/driver-support-faq/technical-support/> for technical support.
- For OEM clients and system integrators developing a product for long term production, other code and resources may also be made available. Please visit our website at <https://www.viatech.com/en/about/contact/> to submit a request.

Appendix A. FX8-100S-SV Connectors

This chapter provides you with information of the board-to-board FX8-100S-SV connectors' pinouts and placement.

A.1. FX8-100S-SV Connectors Pinouts

The VIA VAB-950 comes with two FX8-100S-SV connectors labeled as 'J8' and 'J9'. The FX8-100S-SV connectors are used for connecting the VIA SOM-9X50. The pinouts of the FX8-100S-SV connectors are shown below.

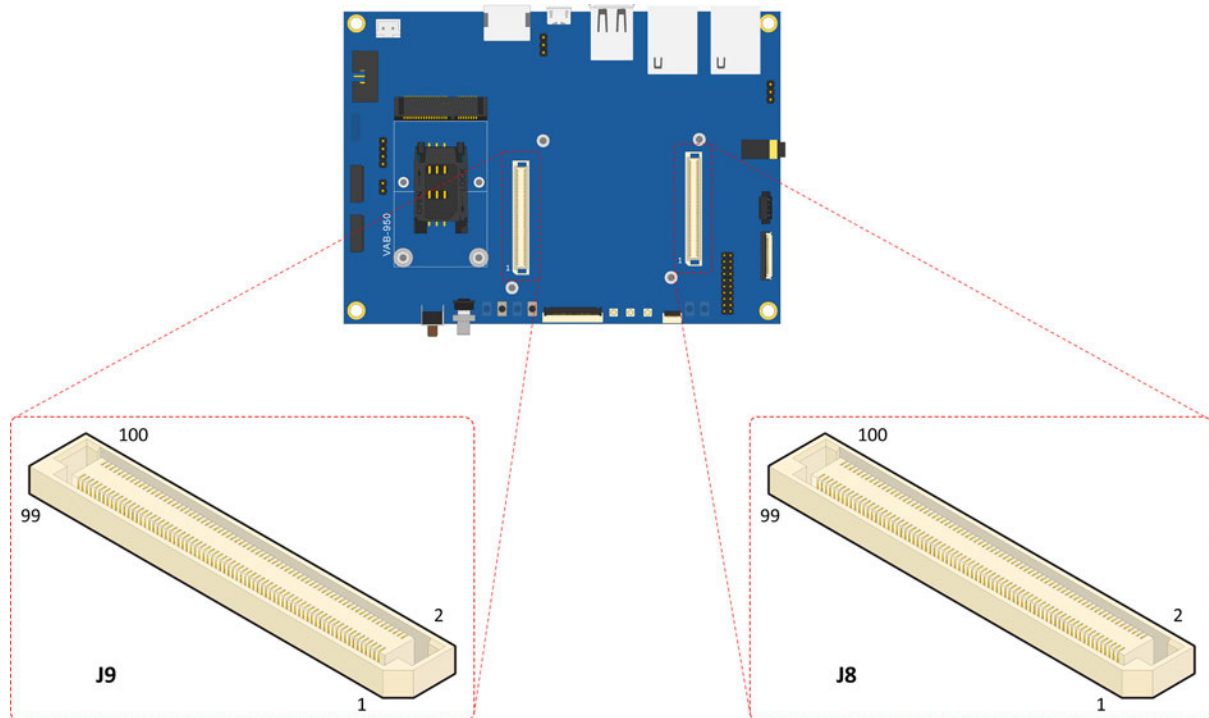

Figure 36: FX8-100S-SV connectors diagram

J9			
Pin	Signal	Pin	Signal
1	GND	2	GND
3	JTRST	4	SCL2_MT
5	SPI_CSB_JTMS	6	SDA2_MT
7	GND	8	GND
9	SPI_CLK_JTCK	10	SCL4_MT
11	GND	12	SDA4_MT
13	SPI_MI_JTDO	14	GND
15	SPI_MO_JTDI	16	SCL6
17	GND	18	SDA6
19	KPROW1	20	GND
21	KPCOLO	22	GPIO116
23	KPROW0	24	GPIO120
25	GND	26	GPIO76
27	DSIO_D3N	28	IT66121_SYSRSTN

J8			
Pin	Signal	Pin	Signal
1	SPI2_CLK	2	GND
3	GND	4	RDP3_B
5	SPI2_MI	6	RDN3_B
7	SPI2_CSB	8	GND
9	SPI2_MO	10	RDP1_B
11	GND	12	RDN1_B
13	I2S3_DO	14	GND
15	I2S0_BCK	16	RDN2_B
17	GND	18	RDP2_B
19	I2S0_LRCK	20	GND
21	I2S0_DI	22	RCN_B
23	BGF_INT	24	RCP_B
25	32K_MT7668	26	GND
27	GND	28	RDPO_B

J9			
29	DSIO_D3P	30	IT66121_INT
31	GND	32	GND
33	DSIO_D0N	34	DPI_D0
35	DSIO_D0P	36	DPI_D1
37	GND	38	DPI_D2
39	DSIO_D1N	40	DPI_D3
41	DSIO_D1P	42	DPI_D4
43	GND	44	DPI_D5
45	DSIO_D2P	46	DPI_D6
47	DSIO_D2N	48	DPI_D7
49	GND	50	DPI_D8
51	DSIO_CKP	52	DPI_D9
53	DSIO_CKN	54	DPI_D10
55	GND	56	DPI_D11
57	DSI_TE	58	GND
59	LCM_RST	60	DPI_DE
61	LCD_AVDD_EN	62	GND
63	DISP_PWM	64	DPI_VSYNC
65	GND	66	DPI_HSYNC
67	SDA3_MT	68	GND
69	SCL3_MT	70	DPI_CK
71	GND	72	GND
73	IDDIG	74	I2S5_BCK
75	GPIO11	76	GND
77	DRVBUS	78	I2S5_LRCK
79	KPCOL2	80	I2S5_DO
81	GPIO151	82	GND
83	GND	84	SDA0_MT
85	GND	86	SCL0_MT
87	GND	88	GND
89	GND	90	SCL1_MT
91	VSYS	92	SDA1_MT
93	VSYS	94	GND
95	VSYS	96	GPIO75
97	VSYS	98	GPIO 60
99	VSYS	100	VBUS

J8			
29	URXD1	30	RDNO_B
31	UTXD1	32	GND
33	GND	34	CAM_PDN2
35	URXD0	36	CAM_RST2
37	UTXD0	38	EINT_RAMDUMP
39	URTS0	40	GND
41	UCTS0	42	CAM_CLK2
43	GND	44	GND
45	GPIO57	46	GPIO80
47	GPIO56	48	GPIO78
49	GPIO53	50	GPIO77
51	GPIO52	52	GPIO79
53	GPIO55	54	GPIO69
55	GPIO54	56	GPIO70
57	GND	58	AU_VIN2_P
59	MSDC1_DAT1	60	GPIO 59
61	MSDC1_DAT0	62	GPIO177
63	MSDC1_DAT2	64	GPIO71
65	MSDC1_DAT3	66	WIFI_INT
67	GND	68	AU_VIN2_N
69	MSDC1_CMD	70	MT7668_PMU_EN
71	GND	72	GPIO72
73	MSDC1_CLK	74	AU_VIN0_N
75	GND	76	AU_VIN0_P
77	USB_P	78	AU_MICBIAS0
79	USB_N	80	SCL5_MT
81	GND	82	SDA5_MT
83	AU_LON	84	GND
85	AU_LOP	86	HOMEKEY_SW
87	GND	88	SYSRSTB
89	HP_MP3R	90	PWRKEY_SW
91	AU_REFN	92	EINT_EAR
93	HP_MP3L	94	HP_EINT
95	GND	96	GND
97	EAR_MIC_P	98	AVSS28_AUD
99	EAR_MIC_N	100	VIO28_PMU

Table 20: FX8-100S-SV connectors pinouts

A.2. FX8-100S-SV Connectors Placement

The following figure shows the placement of the board-to-board FX8-100S-SV connectors on the board.

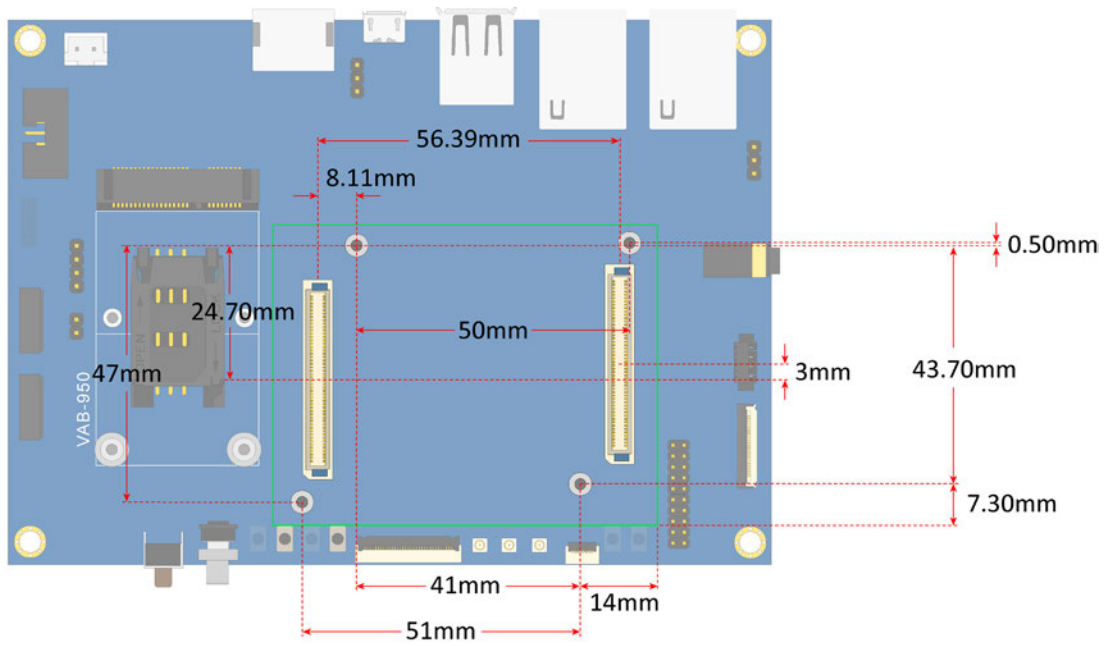

Figure 37: FX8-100S-SV connectors placement

Appendix B. Installing Wireless Accessories

This chapter provides you with information on how to install the miniPCIe mobile broadband module into the VIA VAB-950. It is recommended to use a grounded wrist strap before handling computer components. Electrostatic discharge (ESD) can damage some components.

B.1. Installing the VIA EMIO-2574 Mobile Broadband Module

Step 1

Align the notch on the VIA EMIO-2574 module with its counterpart on the miniPCIe slot on the VIA VAB-950. Then insert the module at a 30° angle.

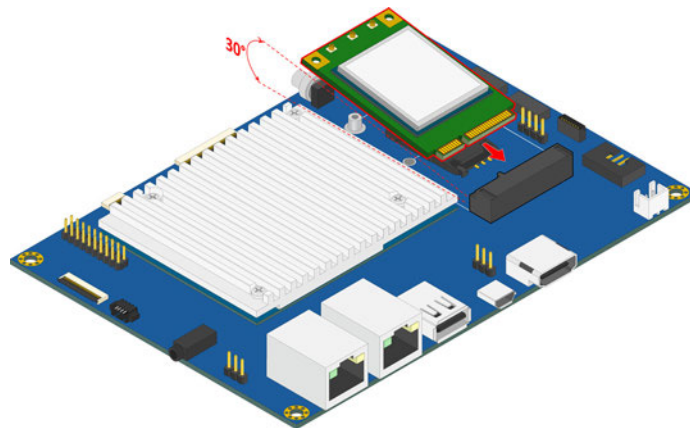

Figure 38: Installing the VIA EMIO-2574 module



Note:

Make sure you have installed the 4G SIM card first into the SIM card slot before installing the VIA EMIO-2574 module.

Step 2

Once the VIA EMIO-2574 module has been fully inserted, push down the module until the screw holes align with the standoff holes and then secure the module with two screws.

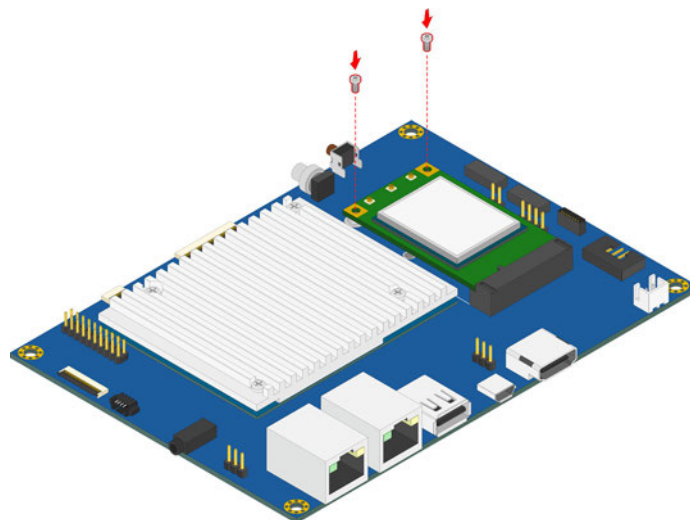

Figure 39: Securing the VIA EMIO-2574 module

Step 3

Insert the 4G antenna cable into the antenna hole from inside of the back panel plate. Insert the washer, fasten it with the nut, and install the antenna.

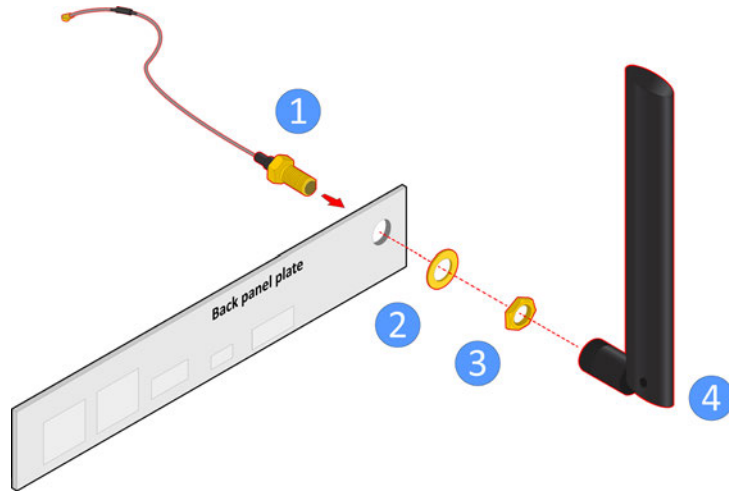

Figure 40: Installing the 4G antenna cable and antenna

Step 4

Connect the other end of the 4G antenna cable to the micro-RF (IPEX) connector labeled 'MAIN' on the VIA EMIO-2574 module.

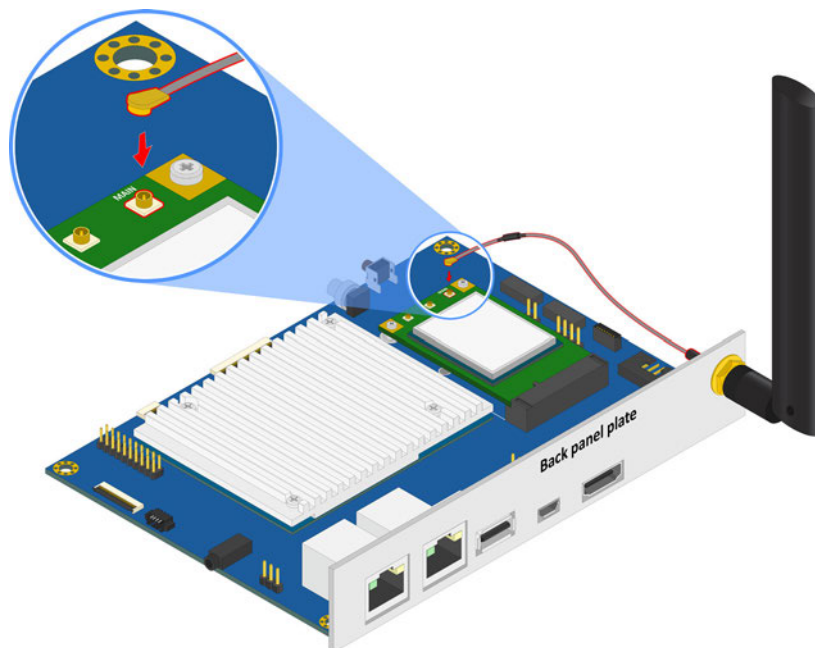

Figure 41: Connecting the 4G antenna cable to VIA EMIO-2574 module

Appendix C. Connecting LCD Display

This chapter provides you with information on how to connect the 10.1" TFT-LCD display to the VIA VAB-950.

C.1. Connecting the 10.1" TFT-LCD Display

Step 1

Attached the 34-pin FFC cable to the MIPI DSI connector labeled 'DSI' on the VIA VAB-950, and then attach the other end of the cable to the 10.1" TFT-LCD display.

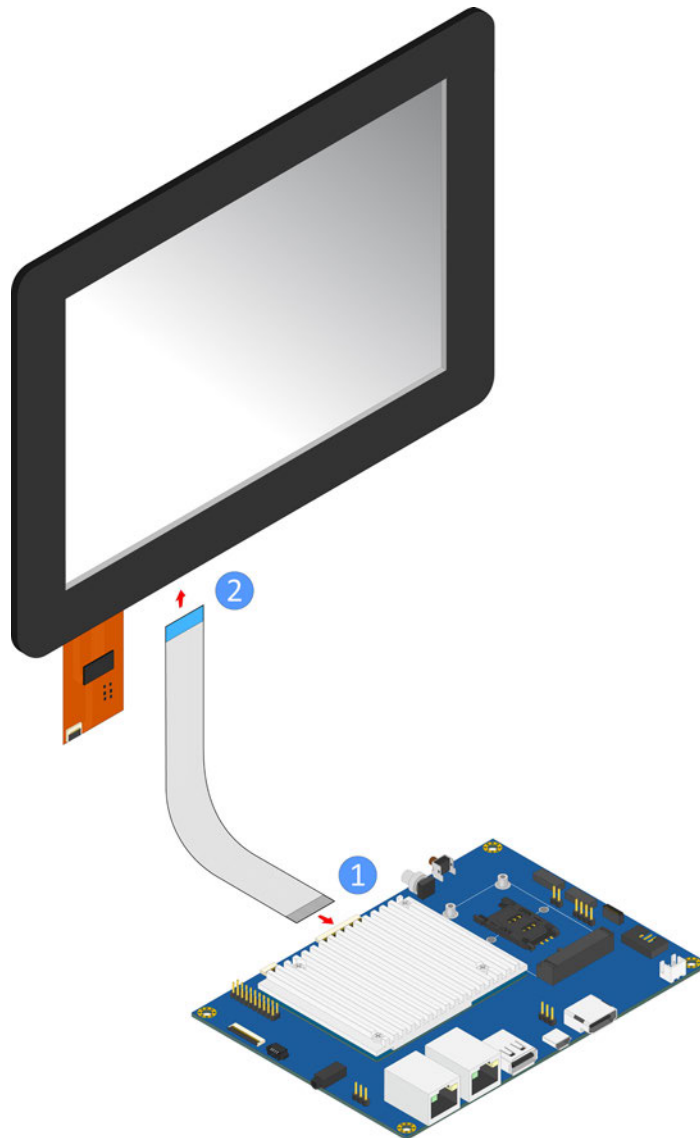

Figure 42: Connecting 34-pin FFC cable to the 10.1" TFT-LCD display

Step 2

Attached the 8-pin FFC cable to the touch screen connector labeled 'JTOUCH' on the VIA VAB-950, and then attach the other end of the cable to the 10.1" TFT-LCD display as shown in the diagram below.

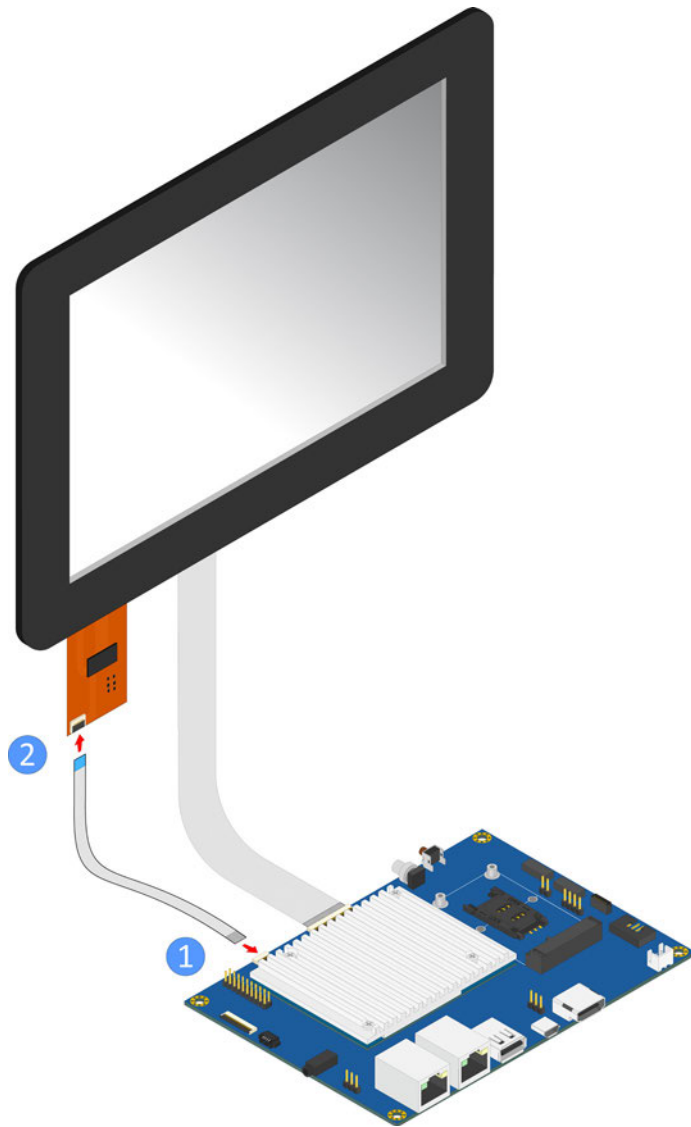

Figure 43: Connecting 8-pin FFC cable to the 10.1" TFT-LCD display



Taiwan Headquarters

1F, 531 Zhong-zheng Road,
Xindian Dist., New Taipei City 231
Taiwan

Tel: 886-2-2218-5452
Fax: 886-2-2218-9860
Email: embedded@via.com.tw



USA

940 Mission Court
Fremont, CA 94539,
USA

Tel: 1-510-687-4688
Fax: 1-510-687-4654
Email: embedded@viatech.com



Japan

3-15-7 Ebisu MT Bldg. 6F,
Higashi, Shibuya-ku
Tokyo 150-0011
Japan

Tel: 81-3-5466-1637
Fax: 81-3-5466-1638
Email: embedded@viatech.co.jp



China

Tsinghua Science Park Bldg. 7
No. 1 Zongguancun East Road,
Haidian Dist., Beijing, 100084
China

Tel: 86-10-59852288
Fax: 86-10-59852299
Email: embedded@viatech.com.cn



Europe

Email: embedded@via-tech.eu