



USER MANUAL

VIA ETX-8X90-10GR

ETX Module with high-performance
multimedia capabilities



Copyright

Copyright © 2016-2020 VIA Technologies Incorporated. All rights reserved.

No part of this document may be reproduced, transmitted, transcribed, stored in a retrieval system, or translated into any language, in any form or by any means, electronic, mechanical, magnetic, optical, chemical, manual or otherwise without the prior written permission of VIA Technologies, Incorporated.

Trademarks

All trademarks are the property of their respective holders.

Disclaimer

No license is granted, implied or otherwise, under any patent or patent rights of VIA Technologies. VIA Technologies makes no warranties, implied or otherwise, in regard to this document and to the products described in this document. The information provided in this document is believed to be accurate and reliable as of the publication date of this document. However, VIA Technologies assumes no responsibility for the use or misuse of the information (including use or connection of extra device/equipment/add-on card) in this document and for any patent infringements that may arise from the use of this document. The information and product specifications within this document are subject to change at any time, without notice and without obligation to notify any person of such change.

VIA Technologies, Inc. reserves the right to make changes to the products described in this manual at any time without prior notice.

Regulatory Compliance

FCC-A Radio Frequency Interference Statement

This equipment has been tested and found to comply with the limits for a class A digital device, pursuant to part 15 of the FCC rules. These limits are designed to provide reasonable protection against harmful interference when the equipment is operated in a commercial environment. This equipment generates, uses, and can radiate radio frequency energy and, if not installed and used in accordance with the instruction manual, may cause harmful interference to radio communications. Operation of this equipment in a residential area is likely to cause harmful interference, in which case the user will be required to correct the interference at his personal expense.

Notice 1

The changes or modifications not expressly approved by the party responsible for compliance could void the user's authority to operate the equipment.

Notice 2

Shielded interface cables and A.C. power cord, if any, must be used in order to comply with the emission limits.

Notice 3

The product described in this document is designed for general use, VIA Technologies assumes no responsibility for the conflicts or damages arising from incompatibility of the product. Check compatibility issue with your local sales representatives before placing an order.



Tested To Comply
With FCC Standards
FOR HOME OR OFFICE USE



Battery Recycling and Disposal

- Only use the appropriate battery specified for this product.
- Do not re-use, recharge, or reheat an old battery.
- Do not attempt to force open the battery.
- Do not discard used batteries with regular trash.
- Discard used batteries according to local regulations.

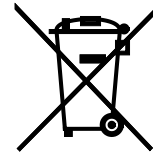

Safety Precautions

- Always read the safety instructions carefully.
- Keep this User's Manual for future reference.
- All cautions and warnings on the equipment should be noted.
- Keep this equipment away from humidity.
- Put this equipment on a reliable flat surface before setting it up.
- Check the voltage of the power source and adjust to 110/220V before connecting the equipment to the power inlet.
- Do not place the power cord where people will step on it.
- Always unplug the power cord before inserting any add-on card or module.
- If any of the following situations arise, get the equipment checked by authorized service personnel:
 - The power cord or plug is damaged.
 - Liquid has entered into the equipment.
 - The equipment has been exposed to moisture.
 - The equipment is faulty or you cannot get it work according to User's Manual.
 - The equipment has been dropped and damaged.
 - The equipment has an obvious sign of breakage.
- Do not leave this equipment in extreme temperatures or in a storage temperature above 60°C (140°F). The equipment may be damaged.
- Do not leave this equipment in direct sunlight.
- Never pour any liquid into the opening. Liquid can cause damage or electrical shock.
- Do not place anything over the power cord.
- Do not cover the ventilation holes. The openings on the enclosure protect the equipment from overheating.

Ordering Information

Part Number	Description
10GAB10440020	ETX-8X90-10GR module with 1.06GHz VIA Eden® X1 CPU with VGA, LVDS, 4 USB 2.0, 2 UART, 10/100Mbps Ethernet, SATA, IDE, 2 PCI, ATX power connector
ETXDB1	ETX-8X90-10GR evaluation carrier board
99G42-01473Q	Heatsink for ETX-8X90-10GR
99G42-100032	Heat spreader for ETX-8X90-10GR

Table of Contents

1. Product Overview	1
1.1. Key Components	1
1.1.1. VIA Eden® X1 Processor	1
1.1.2. VIA VX900 MSP Chipset	1
1.2. Product Specifications	2
1.3. Layout Diagram	4
1.4. Product Dimensions	5
2. I/O Interface	6
2.1. Micro SD Card Slot (optional)	6
2.2. Mini USB 2.0 Ports (optional)	6
2.3. SATA Connector	7
2.4. DC-in Connector	8
2.5. CPU and System Fan Connectors	9
2.6. Clear CMOS Jumper	10
2.7. SPI Connector	11
2.8. ETX Connectors	12
2.8.1. ETX Connector X1 (CNX1)	13
2.8.2. ETX Connector X2 (CNX2)	14
2.8.3. ETX Connector X3 (CNX3)	15
2.8.4. ETX Connector X4 (CNX4)	16
3. Hardware Installation	17
3.1. Mounting the VIA ETX-8X90-10GR module onto the ETXDB1 carrier board	17
4. BIOS Setup Utility	21
4.1. Entering the BIOS Setup Utility	21
4.2. Control Keys	21
4.3. Navigating the BIOS Menus	21
4.4. Getting Help	21
4.5. System Overview	22
4.5.1. AMIBIOS	22
4.5.2. Processor	22
4.5.3. System Memory	22
4.5.4. System Time	22
4.5.5. System Date	22
4.6. Advanced Settings	23
4.6.1. CPU Configuration	24
4.6.2. SATA Configuration	24
4.6.2.1. Hard Disk Information	25
4.6.2.1.1. PIO Mode	25
4.6.2.1.2. DMA Mode	25
4.6.3. SuperIO Configuration	26
4.6.3.1. Serial Ports 1 to 2 Address and IRQ	26
4.6.3.2. Serial Port 2 Mode	26
4.6.3.3. Parallel Port Address	26
4.6.3.4. Parallel Port Mode	26
4.6.3.5. Parallel Port IRQ	26
4.6.4. Hardware Health Configuration	27
4.6.4.1. Smart FAN 1 and FAN 2	27
4.6.5. ACPI Configuration	28
4.6.5.1. Suspend Mode	28
4.6.5.2. ACPI Version Features	28
4.6.6. APM Configuration	29
4.6.6.1. Power Button Mode	29
4.6.6.2. Restore on AC/Power Loss	29
4.6.6.3. Resume On PCI PME#	29

4.6.6.4.	Resume On KBC.....	30
4.6.6.5.	Wake-Up Key.....	30
4.6.6.6.	Wake-Up Password.....	30
4.6.6.7.	Resume On PS/2 Mouse.....	30
4.6.6.8.	Resume on RTC Alarm.....	30
4.6.6.9.	RTC Alarm Date (Days).....	30
4.6.6.10.	System Time.....	31
4.6.7.	Spread Spectrum Configuration.....	31
4.6.7.1.	CPU Spread Spectrum Setting.....	31
4.6.8.	USB Configuration.....	32
4.6.9.	CRB Configuration.....	32
4.6.9.1.	DRAM Clock.....	33
4.6.9.2.	Select Display Device 1 and 2.....	33
4.6.9.3.	Panel Type.....	33
4.6.9.4.	VGA Share Memory (Frame Buffer).....	33
4.6.9.5.	OnChip HDAC Device.....	33
4.6.9.6.	SMBus Device Switch.....	33
4.6.9.7.	SDIO Host controller.....	33
4.6.9.8.	WATCH-DOG.....	33
4.6.9.9.	Unit-Select.....	33
4.6.9.10.	Time-Select.....	34
4.6.9.11.	Backlight Control.....	34
4.6.9.12.	Backlight PWM Clock.....	34
4.6.9.13.	LAN Boot ROM.....	34
4.7.	Boot Settings.....	35
4.7.1.	Boot Settings Configuration.....	35
4.7.1.1.	Quick Boot.....	36
4.7.1.2.	Quiet Boot.....	36
4.7.1.3.	Bootup Num-Lock.....	36
4.7.1.4.	Wait for 'F1' if Error.....	36
4.7.1.5.	Hit 'DEL' Message Display.....	36
4.7.2.	Boot Device Priority.....	37
4.7.2.1.	1 st Boot Device.....	37
4.8.	Security Settings.....	38
4.8.1.	Change Supervisor Password.....	38
4.8.2.	User Access Level.....	38
4.8.3.	Change User Password.....	39
4.8.4.	Clear User Password.....	39
4.8.5.	Password Check.....	39
4.9.	Exit Options.....	40
4.9.1.	Save Changes and Exit.....	40
4.9.2.	Discard Changes and Exit.....	40
4.9.3.	Discard Changes.....	40
4.9.4.	Load Optimal Defaults.....	40
5.	Software and Technical Support.....	41
5.1.	Microsoft and Linux Support.....	41
5.1.1.	Driver Installation.....	41
5.2.	Technical Support and Assistance.....	41
Appendix A.	ETXDB1 Carrier Board Reference.....	42
A.1.	Board Specifications.....	42
A.1.1.	Board Storage Channel Configuration.....	43
A.2.	External I/O Connectors.....	44
A.2.1.	Rear I/O Ports.....	44
A.3.	ETXDB1 Layout Diagram.....	45
A.3.1.	Onboard Connectors and Slots.....	45
A.3.2.	Onboard Pin headers and Jumpers.....	46
A.3.3.	Connectors and Slots Pin Definition.....	47

A.3.3.1. ATX1 : 20-pin ATX Power Connector	47
A.3.3.2. ISA1 : ISA Slot	48
A.3.3.3. PCI1 and PCI2: PCI Slots.....	49
A.3.3.4. IDE1 and IDE2: IDE Connectors.....	51
A.3.3.5. LVDS1: LVDS Panel Connector.....	52
A.3.3.6. BL1: Backlight Connector	52
A.3.3.7. CNX1~ CNX4: ETX Connector X1, X2, X3 and X4.....	53
A.3.4. Pin Headers and Jumpers Pin Definition	57
A.3.4.1. F_AUDIO1 and I2C1: Front Audio and I ² C Pin Headers	57
A.3.4.2. SIR1 and SMB1: Serial Infrared and SMBus Pin Headers	58
A.3.4.3. F_PANEL1 and LPT1: Front Panel and LPT Pin Headers.....	59
A.3.4.4. COM2 and KBMS1: COM and Keyboard & Mouse Pin Headers.....	60
A.3.4.5. J1: Backlight and Panel Power Jumper.....	61
A.4. ETXDB1 Dimensions.....	62
A.4.1. ETXDB1 Board Dimensions.....	62
A.4.2. ETXDB1 External I/O Dimensions	62

List of Figures

Figure 1: Layout diagram of the VIA ETX-8X90-10GR module (top side).....	4
Figure 2: Layout diagram of the VIA ETX-8X90-10GR module (bottom side)	4
Figure 3: Dimensions of the VIA ETX-8X90-10GR module (top view)	5
Figure 4: Dimensions of the VIA ETX-8X90-10GR module (bottom view)	5
Figure 5: Micro SD card slot diagram.....	6
Figure 6: Mini USB 2.0 ports diagram	6
Figure 7: SATA connector diagram.....	7
Figure 8: DC-in connector diagram.....	8
Figure 9: CPU and System fan connectors diagram.....	9
Figure 10: Clear CMOS jumper diagram.....	10
Figure 11: SPI connector diagram.....	11
Figure 12: ETX connectors diagram.....	12
Figure 13: Carrier board ETX connectors and mounting holes.....	17
Figure 14: Installing the VIA ETX-8X90-10GR module on the carrier board.....	17
Figure 15: Inserting the memory module	18
Figure 16: Removing the thermal pad cover.....	18
Figure 17: Installing the heatsink/heat spreader on the VIA ETX-8X90-10GR module	19
Figure 18: Securing the heatsink/heat spreader and VIA ETX-8X90-10GR module	20
Figure 19: Illustration of the Main menu screen.....	22
Figure 20: Illustration of the Advanced Settings screen	23
Figure 21: Illustration of the CPU Configuration screen.....	24
Figure 22: Illustration of the SATA Configuration screen	24
Figure 23: Illustration of the SATA-1 Primary IDE screen.....	25
Figure 24: Illustration of the SuperIO Configuration screen	26
Figure 25: Illustration of the Hardware Health Configuration screen.....	27
Figure 26: Illustration of the ACPI Configuration screen.....	28
Figure 27: Illustration of the APM Configuration screen	29
Figure 28: Illustration of the Spread Spectrum Configuration screen.....	31
Figure 29: Illustration of the USB Configuration screen	32
Figure 30: Illustration of the CRB Configuration screen	32
Figure 31: Illustration of the Boot Settings screen	35
Figure 32: Illustration of the Boot Settings Configuration screen	35
Figure 33: Illustration of Boot Device Priority screen	37
Figure 34: Illustration of the Security Settings screen.....	38
Figure 35: Illustration of the Exit Options screen.....	40
Figure 36: Rear I/O ports	44
Figure 37: ETXDB1 connectors and slots diagram	45
Figure 38: ETXDB1 pin headers and jumpers diagram	46
Figure 39: ATX Power connector diagram	47
Figure 40: ISA slot diagram.....	48
Figure 41: PCI slot diagram.....	49
Figure 42: IDE connector diagram.....	51
Figure 43: LVDS panel connector diagram.....	52
Figure 44: Backlight connector diagram.....	52
Figure 45: ETX connector X1, X2, X3 and X4 diagram	53
Figure 46: Front audio and I ² C pin headers diagram.....	57
Figure 47: Serial Infrared and SMBus pin headers diagram	58
Figure 48: Front panel and LPT pin headers diagram	59
Figure 49: COM and Keyboard & mouse pin headers diagram	60
Figure 50: Backlight and Panel power jumper diagram.....	61
Figure 51: ETXDB1 board dimensions diagram.....	62
Figure 52: ETXDB1 External I/O dimensions diagram.....	62

List of Tables

Table 1: Micro SD card slot pinouts.....	6
Table 2: Mini USB 2.0 ports pinouts.....	6
Table 3: SATA connector pinouts.....	7
Table 4: DC-in connector pinouts.....	8
Table 5: CPU and System fan connectors pinouts	9
Table 6: Clear CMOS jumper settings	10
Table 7: SPI connector pinouts.....	11
Table 8: ETX connector X1 pinouts.....	13
Table 9: ETX connector X2 pinouts.....	14
Table 10: ETX connector X3 pinouts	15
Table 11: ETX connector X4 pinouts	16
Table 12: Serial port addresses and IRQs.....	26
Table 13: Panel types resolution.....	33
Table 14: ETXDB1 and VIA ETX-8X90-10GR storage configuration.....	43
Table 15: Description table of the ETXDB1 connectors and slots	45
Table 16: Description table of the ETXDB1 pin headers and jumpers	46
Table 17: ATX Power connector pinouts.....	47
Table 18: ISA slot pinouts.....	48
Table 19: PCI slot 1 pinouts	49
Table 20: PCI slot 2 pinouts	50
Table 21: IDE connector pinouts.....	51
Table 22: LVDS panel connector pinouts	52
Table 23: Backlight connector pinouts	52
Table 24: ETX connector X1 pinouts	53
Table 25: ETX connector X2 pinouts	54
Table 26: ETX connector X3 pinouts	55
Table 27: ETX connector X4 pinouts	56
Table 28: Front audio pin header pinouts.....	57
Table 29: I ² C pin header pinouts.....	57
Table 30: Serial Infrared pin header pinouts	58
Table 31: SMBus pin header pinouts.....	58
Table 32: Front panel pin header pinouts.....	59
Table 33: LPT pin header pinouts	59
Table 34: COM pin header pinouts	60
Table 35: Keyboard & mouse pin header pinouts.....	60
Table 36: Backlight and Panel power jumper settings.....	61

1. Product Overview

The VIA ETX-8X90-10GR is a compact and highly integrated Computer-On-Module based on standard Embedded Technology eXtended form factor. It comes with a power efficient 1.06GHz VIA Eden® X1 processor, and VIA VX900 MSP chipset featuring the VIA C-9 HD DX9 with 3D/2D graphics and video decoding accelerator for rich digital media performance. Moreover, it provides support for extensive connectivity options including USB, Ethernet, Audio, PCI, ISA, IDE and graphics through board-to-board connectors to an I/O carrier board. The VIA ETX-8X90-10GR module is designed for embedded applications such as test machines, measuring equipment, digital signage, medical PCs, industrial automation, and transportation.

1.1. Key Components

1.1.1. VIA Eden® X1 Processor

The VIA Eden® X1 is a 64-bit superscalar x86 single core processor based on a 28 nanometer process technology. Packed into an ultra-compact NanoBGA2 package, it delivers an energy-efficient yet powerful performance, with cool and quiet operation. Featuring the ultra-low-power VIA Eden® X1 processor, the VIA ETX-8X90-10GR is ideal for embedded system applications such as test machines, measuring equipment, digital signage, medical PCs, industrial automation, and transportation.

1.1.2. VIA VX900 MSP Chipset

The VIA VX900 MSP chipset is designed to enable high quality digital video streaming and DVD playback. The VIA VX900 features VIA C-9 HD DX9 with 3D/2D graphics and video accelerators, DDR3 1066 support, motion compensation and dual display support to ensure a rich overall entertainment experience.

1.2. Product Specifications

Core

Processor

- 1.06GHz VIA Eden® X1

Chipset

- VIA VX900 MSP

System Memory

- 1 x DDR3 1066 SODIMM slot
- Up to 4GB memory size

On-board BIOS

- AMI BIOS
- 8Mbit SPI flash memory

Operating System

- Microsoft Windows 7
- Microsoft Windows XPe
- Microsoft Windows Embedded System 7
- Microsoft Windows CE6.0
- Linux

Hardware Monitoring

- CPU/System temperature reading
- CPU/System fan speed reading
- System voltage monitoring

System Monitoring and Management

- Wake-on-LAN
- System power management
- AC power failure recovery
- Watchdog Timer
- CPU/System fan power connector

Graphics and Video

Graphics processor

- Integrated VIA C-9 HD DX9 3D/2D graphics with MPEG-2, WMV9, VC-1, and H.264 video decoding accelerator

Graphics Memory

- UMA, up to 512MB (BIOS setting)

CRT

- 350MHz RAMDAC
- Supports up to 2048x1536 resolution (optional)

LCD

- Supports dual-channel 18-bit/24-bit LVDS panel

Ethernet

Chipset

- Realtek RTL8139DL Ethernet Controller

Storage

Micro SD card slot

- 1 x Micro SD card slot (supports OS boot on Linux and Windows CE) (optional)

Hard disk

- 1 x SATA 3.0Gbps port (SATA2 on module)
- 2 x IDE connectors (2nd optional)

Input/Output**Audio**

- VT2021 Audio Codec

LAN

- 10/100Mbps Ethernet (Realtek RTL8139DL)

USB

- Supports up to four USB 2.0 ports (on carrier board)
- Supports up to two mini USB 2.0 ports (on module) (optional)

LPT

- Supports one LPT port

COM

- Supports two UART ports

Super IO

- Fintek F71869ED

IrDA

- Supports SIR

Keyboard/Mouse

- Supports PS/2 keyboard and mouse

Expansion Buses

- Supports SMBus interface
- Supports I²C bus
- Supports PCI 2.3, 32bit/33MHz, 2 slots
- Supports ISA bus (ETX 3.0 compliant) (DMA transfer not supported)

**Mechanical
and
Environment****ETX Compliance**

- ETX 3.0*, compact module

Dimensions

- 95mm x 114mm (9.5cm x 11.4cm, 3.7" x 4.5")

Operating Temperature

- 0°C ~ 60°C

Storage Temperature

- -40°C ~ 70°C

Operating Humidity

- 0% ~ 95% (relative humidity; non-condensing)

**Note:**

As the operating temperature provided in the specifications is a result of testing performed in a testing chamber, a number of variables can influence this result. Please note that the working temperature may vary depending on the actual situation and environment. It is highly recommended to execute a solid testing program and take all variables into consideration when building the system. Please ensure that the system is stable under at the required operating temperature in terms of application.

1.3. Layout Diagram

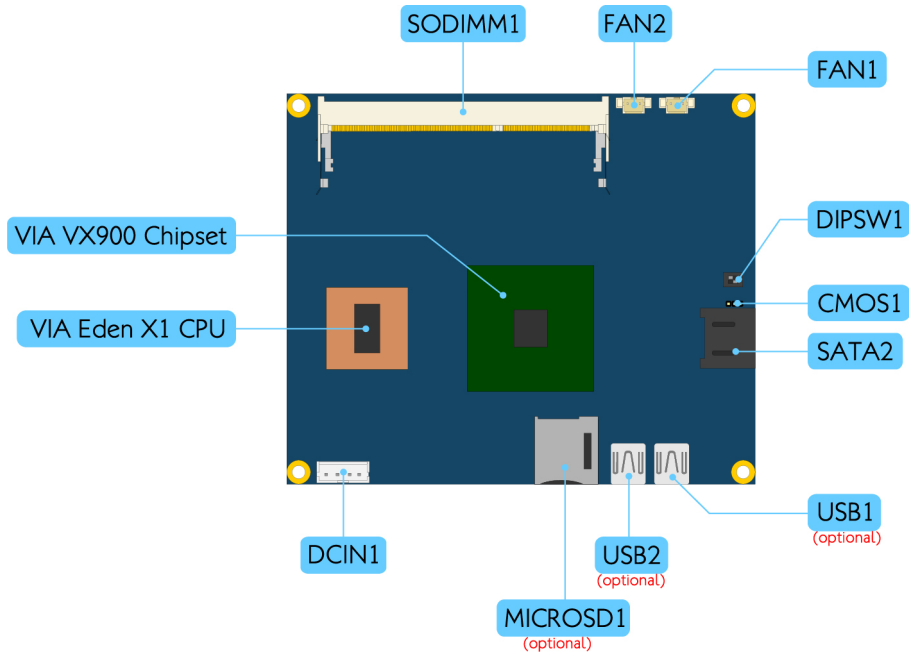

Figure 1: Layout diagram of the VIA ETX-8X90-10GR module (top side)

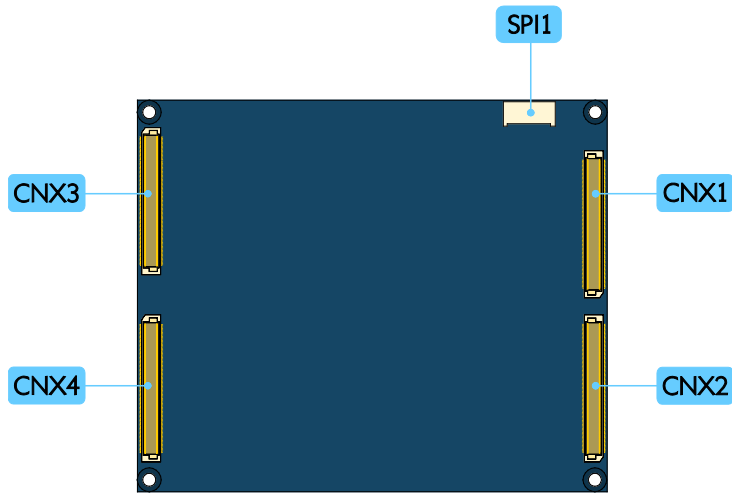

Figure 2: Layout diagram of the VIA ETX-8X90-10GR module (bottom side)

1.4. Product Dimensions

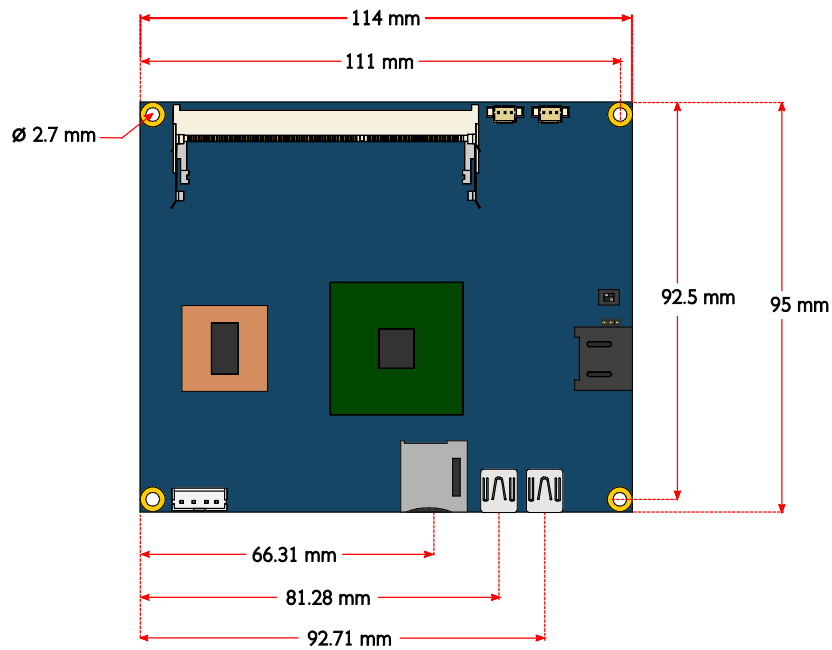

Figure 3: Dimensions of the VIA ETX-8X90-10GR module (top view)

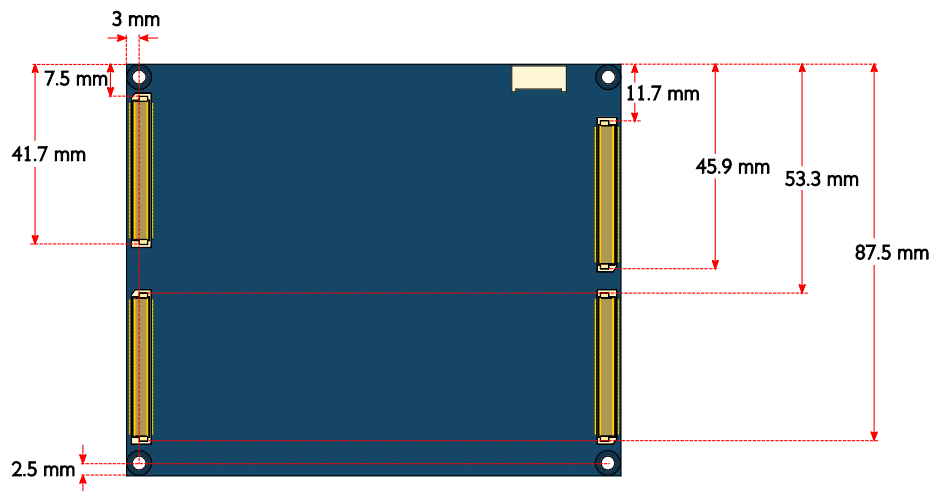

Figure 4: Dimensions of the VIA ETX-8X90-10GR module (bottom view)

2. I/O Interface

This chapter provides information about the VIA ETX-8X90-10GR's onboard I/O connector and its functionality.

2.1. Micro SD Card Slot (optional)

The VIA ETX-8X90-10GR has a micro SD card slot that can provide additional storage data for flash memory micro SD card. The micro SD card slot can also be used for operating system booting for Window CE and Linux. The pinouts of the Micro SD card slot are shown below.

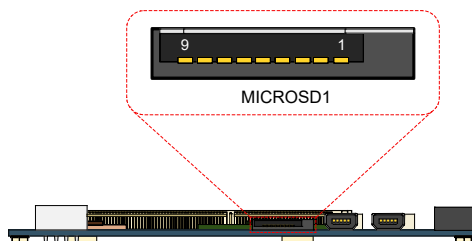

Figure 5: Micro SD card slot diagram

Pin	Signal
1	CR_D2
2	CR_D3
3	CR_CMD
4	VCCCRPWR
5	CR_CLK
6	GND
7	CR_D0
8	CR_D1
9	-CR_CD

Table 1: Micro SD card slot pinouts

2.2. Mini USB 2.0 Ports (optional)

There are two integrated mini USB 2.0 ports on VIA ETX-8X90-10GR module labeled as "USB1" and "USB2". The mini USB port gives complete plug and play and hot swap capability for external devices. Each port is using the USB mini-AB type receptacle connector. The pinouts of the mini USB 2.0 ports are shown below.

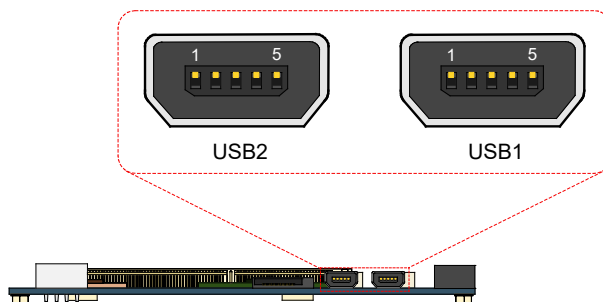

Figure 6: Mini USB 2.0 ports diagram

Mini USB port 1		Mini USB port 2	
Pin	Signal	Pin	Signal
1	+5VSUS	1	+5VSUS
2	USB4-	2	USB5-
3	USB4+	3	USB5+
4	GND	4	GND
5	GND	5	GND

Table 2: Mini USB 2.0 ports pinouts

2.3. SATA Connector

The SATA connector labeled as SATA2 onboard can support up to 3.0Gbps transfer speeds. The SATA connector has 7th pin that can provide +5V power to a SATA Disk-On-Module (DOM). When a regular SATA hard drive is connected, the 7th pin will be a ground pin. The pinouts of the SATA connector are shown below.

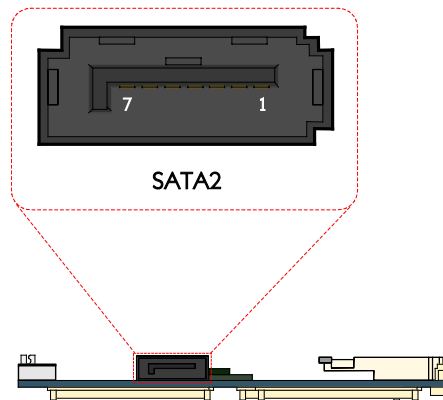

Figure 7: SATA connector diagram

SATA2 connector	
Pin	Signal
1	GND
2	STXP_1
3	STXN_1
4	GND
5	SRXN_1
6	SRXP_1
7	GND

Table 3: SATA connector pinouts



Note:

The default setting of the pin 7 of the SATA connector is GND. The support of +5V is a factory option.

2.4. DC-in Connector

The VIA ETX-8X90-10GR module has an onboard +5V DC-in 4-pin power connector to connect the DC-in power cable. The DC-in connector is labeled as "DCIN1". The pinouts of the DC-in connector are shown below.

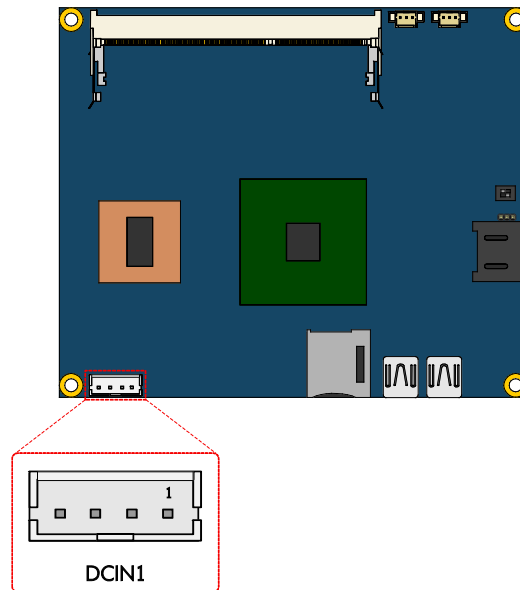

Figure 8: DC-in connector diagram

Pin	Signal
1	+5VSB
2	+5VSB
3	GND
4	GND

Table 4: DC-in connector pinouts



Note:

The DCIN1 connector is not for production use. It is reserved for debugging purposes only.

2.5. CPU and System Fan Connectors

There are two fan connectors on the module running on +5V for maintaining CPU and System cooling. The fan connector for the CPU is labeled as "FAN1" and the fan connector for the System is labeled as "FAN2". The fans provide variable speeds controlled by the BIOS. The fans can be forced to operate at full speed by disabling the Smart Fan feature in the BIOS. The pinouts of the fan connectors are shown below.

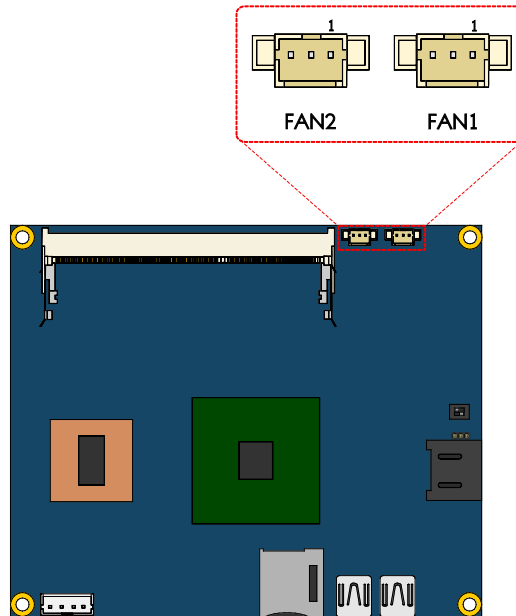

Figure 9: CPU and System fan connectors diagram

CPU fan (FAN1)		System fan (FAN2)	
Pin	Signal	Pin	Signal
1	FANIN1	1	FANIN2
2	FANCTL1 (+5V)	2	FANCTL2 (+5V)
3	GND	3	GND

Table 5: CPU and System fan connectors pinouts

2.6. Clear CMOS Jumper

The onboard CMOS RAM stores system configuration data and has an onboard battery power supply. To reset the CMOS settings, set the jumper on pins 2 and 3 while the system is off. Return the jumper to pins 1 and 2 afterwards. Setting the jumper while the system is on will damage the board. The default setting is on pins 1 and 2.

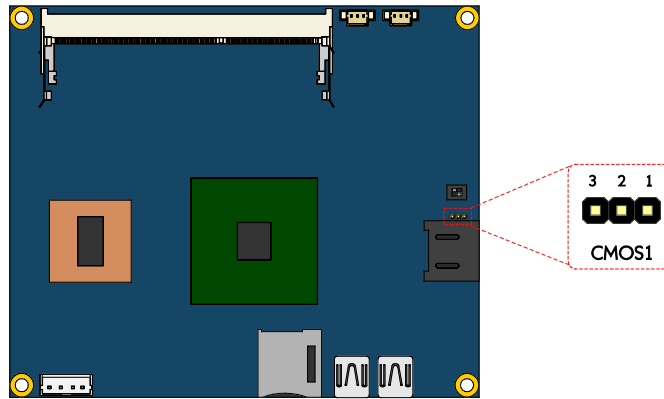

Figure 10: Clear CMOS jumper diagram

Setting	Pin 1	Pin 2	Pin 3
Normal (default setting)	Short	Short	Open
Clear CMOS	Open	Short	Short

Table 6: Clear CMOS jumper settings



Note:

Except when clearing the RTC RAM, never remove the cap from the CLEAR_CMOS jumper default position. Removing the cap will cause system boot failure. Avoid clearing the CMOS while the system is on; it will damage the board.

2.7. SPI Connector

The VIA ETX-8X90-10GR module has one 8-pin SPI flash connector. The SPI (Serial Peripheral Interface) flash connector is used to connect the SPI BIOS programming fixture for updating the SPI flash ROM or for debugging purposes. The SPI flash connector is labeled as "SPI1". The pinouts of the SPI connector are shown below.

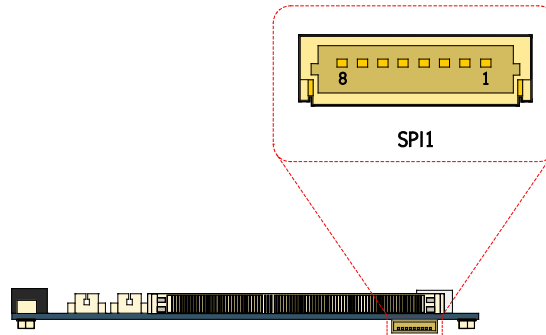

Figure 11: SPI connector diagram

Pin	Signal
1	NC
2	NC
3	MSPIDO
4	MSPIDI
5	MSPICLK
6	MSPISS0
7	GND
8	SPIVCC

Table 7: SPI connector pinouts



Note:

The SPI1 connector is not for production use. It is reserved for debugging purposes only.

2.8. ETX Connectors

The VIA ETX-8X90-10GR module has four ETX connectors labeled as “CNX1, CNX2, CNX3 and CNX4”. These connectors are designed to provide interface to the carrier board/baseboard.

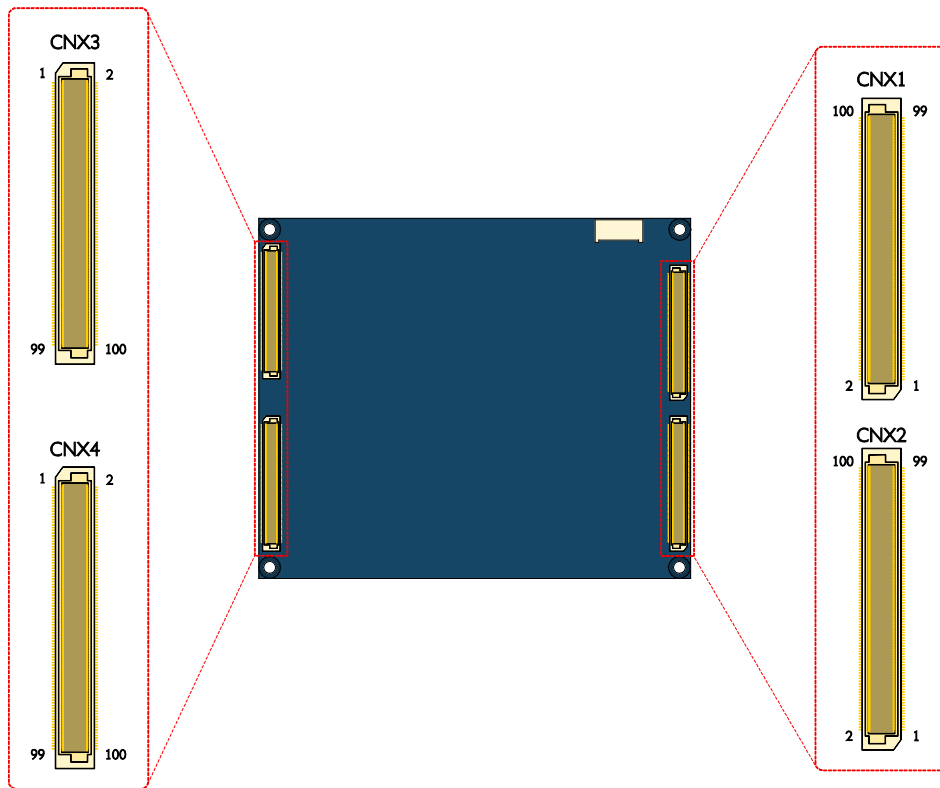

Figure 12: ETX connectors diagram

2.8.1. ETX Connector X1 (CNX1)

The ETX connector X1 contains signal groups of PCI bus, USB and Audio interface. The pinouts of the connector X1 are shown below.

CNX1							
Pin	Signal	Pin	Signal	Pin	Signal	Pin	Signal
1	GND	2	GND	51	+5V	52	+5V
3	PCICLK_3	4	PCICLK_4	53	PAR	54	-SERR
5	GND	6	GND	55	-PERR	56	NC
7	PCLK1	8	PCLK2	57	-PME	58	USB2-
9	-REQ3_ETX	10	-GNT3_ETX	59	-PLOCK	60	-DEVSEL
11	GNT2_ETX	12	+3.3V	61	-TRDY	62	USB3-
13	REQ2_ETX	14	-GNT1_ETX	63	-IRDY	64	-STOP
15	REQ1_ETX	16	+3.3V	65	-FRAME	66	USB2+
17	-GNT0_ETX	18	NC	67	GND	68	GND
19	+5V	20	+5V	69	AD16	70	-CBE2
21	SERIRQ1	22	-REQ0_ETX	71	AD17	72	USB3+
23	AD0	24	+3.3V	73	AD19	74	AD18
25	AD1	26	AD2	75	AD20	76	USB0-
27	AD4	28	AD3	77	AD22	78	AD21
29	AD6	30	AD5	79	AD23	80	USB1-
31	-CBE0	32	AD7	81	AD24	82	-CBE3
33	AD8	34	AD9	83	+5V	84	+5V
35	GND	36	GND	85	AD25	86	AD26
37	AD10	38	AUXAL	87	AD28	88	USB0+
39	AD11	40	MIC	89	AD27	90	AD29
41	AD12	42	AUXAR	91	AD30	92	USB1+
43	AD13	44	ASVCC	93	-PCIRST	94	AD31
45	AD14	46	SNDL	95	-INTC	96	-INTD
47	AD15	48	ASGND	97	-INTA	98	-INTB
49	-CBE1	50	SNDR	99	GND	100	GND

Table 8: ETX connector X1 pinouts

2.8.2. ETX Connector X2 (CNX2)

The ETX connector X2 contains signal group of ISA bus interface. The pinouts of the connector X2 are shown below.

CNX2							
Pin	Signal	Pin	Signal	Pin	Signal	Pin	Signal
1	GND	2	GND	51	+5V	52	+5V
3	SD14	4	SD15	53	SA6	54	IRQ5
5	SD13	6	-MASTER	55	SA7	56	IRQ6
7	SD12	8	DREQ7	57	SA8	58	IRQ7
9	SD11	10	-DACK7	59	SA9	60	SYS_CLK
11	SD10	12	DREQ6	61	SA10	62	-REFRESH
13	SD9	14	-DACK6	63	SA11	64	DREQ1
15	SD8	16	DREQ5	65	SA12	66	-DACK1
17	-MEMW	18	-DACK5	67	GND	68	GND
19	-MEMR	20	DREQ0	69	SA13	70	DREQ3
21	LA17	22	-DACK0	71	SA14	72	-DACK3
23	LA18	24	ISA_IRQ14	73	SA15	74	-IOR
25	LA19	26	ISA_IRQ15	75	SA16	76	-IOW
27	LA20	28	IRQ12	77	SA18	78	SA17
29	LA21	30	IRQ11	79	SA19	80	-SMEMR
31	LA22	32	IRQ10	81	-IOCHRDY	82	AEN
33	LA23	34	-IOCS16	83	+5V	84	+5V
35	GND	36	GND	85	SD0	86	-SMEMW
37	-SBHE	38	-MEMCSI6	87	SD2	88	SD1
39	SA0	40	ISA_OSC	89	SD3	90	-OWS
41	SA1	42	BALE	91	DREQ2	92	SD4
43	SA2	44	TC	93	SD5	94	IRQ9
45	SA3	46	-DACK2	95	SD6	96	SD7
47	SA4	48	IRQ3	97	-IOCHCK	98	-RSTDRV
49	SA5	50	IRQ4	99	GND	100	GND

Table 9: ETX connector X2 pinouts

2.8.3. ETX Connector X3 (CNX3)

The ETX connector X3 contains signal groups of VGA, LCD, Video, COM, LPT and PS2 interfaces. The pinouts of the connector X3 are shown below.

CNX3							
Pin	Signal	Pin	Signal	Pin	Signal	Pin	Signal
1	GND	2	GND	51	NC	52	NC
3	REDN	4	BLUEN	53	+5V	54	GND
5	HS	6	GREENN	55	P_-STB	56	P_-AFD
7	VS	8	DDCCLKN	57	NC	58	P_PRD7
9	NC	10	DDCDATAN	59	IRRX	60	P_-ERR
11	LVDSCLK2-	12	LVDS7-	61	IRTX	62	P_PRD6
13	LVDSCLK2+	14	LVDS7+	63	SIN2	64	P_-INIT
15	GND	16	GND	65	GND	66	GND
17	LVDS5+	18	LVDS6+	67	-RTS2	68	P_PRD5
19	LVDS5-	20	LVDS6-	69	-DTR2	70	P_-SLIN
21	GND	22	GND	71	-DCD2	72	P_PRD4
23	LVDS3-	24	LVDS4+	73	-DSR2	74	P_PRD3
25	LVDS3+	26	LVDS4-	75	-CTS2	76	P_PRD2
27	GND	28	GND	77	SOUT2	78	P_PRD1
29	LVDS2-	30	LVDSCLK1+	79	-RI2	80	P_PRD0
31	LVDS2+	32	LVDSCLK1-	81	+5V	82	+5V
33	GND	34	GND	83	SIN1	84	P_-ACK
35	LVDS0+	36	LVDS1+	85	-RTS1	86	P_BUSY
37	LVDS0-	38	LVDS1-	87	-DTR1	88	P_PE
39	+5V	40	+5V	89	-DCD1	90	P_SLCT
41	JILI_DAT	42	NC	91	-DSR1	92	MSCK
43	JILI_CLK	44	BLON	93	-CTS1	94	MSDT
45	BIASON	46	DIGON	95	SOUT1	96	KBCK
47	NC	48	NC	97	-RI1	98	KBDT
49	NC	50	NC	99	GND	100	GND

Table 10: ETX connector X3 pinouts

2.8.4. ETX Connector X4 (CNX4)

The ETX connector X4 contains signal groups of IDE, Ethernet and Miscellaneous signal interfaces. The pinouts of the connector X4 are shown below.

CNX4							
Pin	Signal	Pin	Signal	Pin	Signal	Pin	Signal
1	GND	2	GND	51	-SDIOW	52	-PDIOR
3	+5VSB	4	PWRGIN	53	SDDREQ	54	-PDIOW
5	PS_ON-	6	SPEAK_BZ	55	SDD15	56	PDDREQ
7	PW_BN-	8	+3.3VBAT	57	SDD0	58	PDD15
9	NC	10	LILED-	59	SDD14	60	PDD0
11	RSMRST-	12	ACTLED-	61	SDD1	62	PDD14
13	NC	14	SPEEDLED-	63	SDD13	64	PDD1
15	NC	16	I ² C_CLK	65	GND	66	GND
17	+5V	18	+5V	67	SDD2	68	PDD13
19	OVCR-	20	NC	69	SDD12	70	PDD2
21	-EXTSMI	22	I ² C_DAT	71	SDD3	72	PDD12
23	SMBCLK	24	SMBDATA	73	SDD11	74	PDD3
25	-SDCS3	26	-SMBALRT	75	SDD4	76	PDD11
27	-SDCS1	28	-HD_LED	77	SDD10	78	PDD4
29	SDA2	30	-PDCS3	79	SDD5	80	PDD10
31	SDA0	32	-PDCS1	81	+5V	82	+5V
33	GND	34	GND	83	SDD9	84	PDD5
35	SPDIG	36	PDA2	85	SDD6	86	PDD9
37	SDA1	38	PDA0	87	SDD8	88	PDD6
39	IRQ15	40	PDA1	89	GPE2-	90	PPDIG
41	-BATLOW	42	GPE1-	91	LAN_RXD-	92	PDD8
43	-SDDACK	44	IRQ14	93	LAN_RXD+	94	SDD7
45	SIORDY	46	-PDDACK	95	LAN_TXD-	96	PDD7
47	-SDIOR	48	PIORDY	97	LAN_TXD+	98	-HDRST
49	+5V	50	+5V	99	GND	100	GND

Table 11: ETX connector X4 pinouts

3. Hardware Installation

3.1. Mounting the VIA ETX-8X90-10GR module onto the ETXDB1 carrier board

Step 1

Align the four ETX connectors and mounting holes of the VIA ETX-8X90-10GR module with the ETX connectors and mounting holes on the ETXDB1 carrier board.

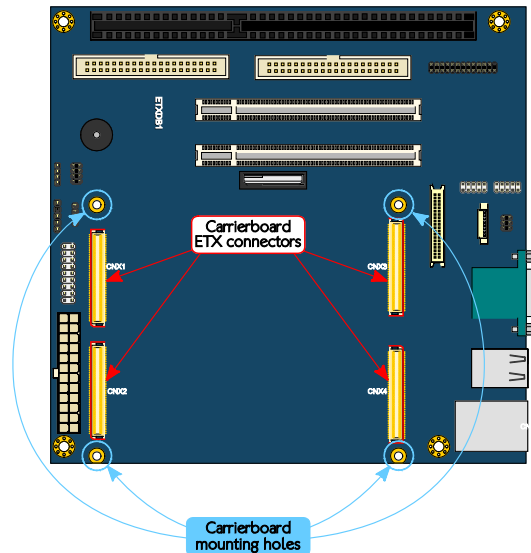

Figure 13: Carrier board ETX connectors and mounting holes

Step 2

Gently press down the VIA ETX-8X90-10GR module until the four ETX connectors are fully inserted into the ETX connectors on the ETXDB1 carrier board.

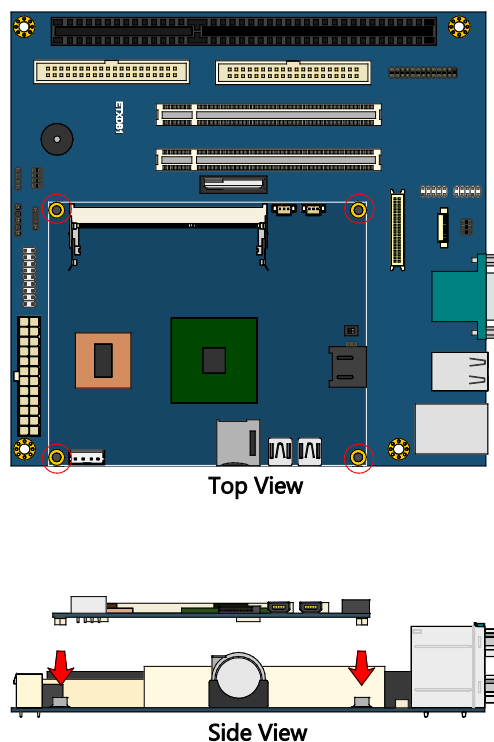

Figure 14: Installing the VIA ETX-8X90-10GR module on the carrier board

Step 3

Align the notch on the memory module with its counterpart on the SODIMM slot, and then insert the memory module at a 30° angle.

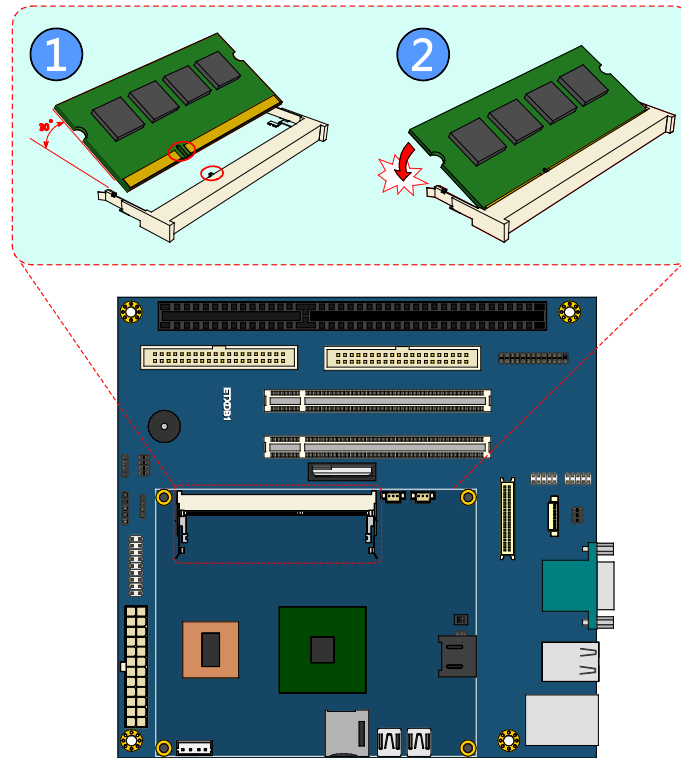

Figure 15: Inserting the memory module

Step 4

Push down until the memory module snaps into place. The memory slot has two locking mechanisms that will click once the memory module has been fully inserted.

Step 5

Flip over the heatsink/heat spreader. Remove the plastic cover from the thermal pad of the memory, chipset and module.

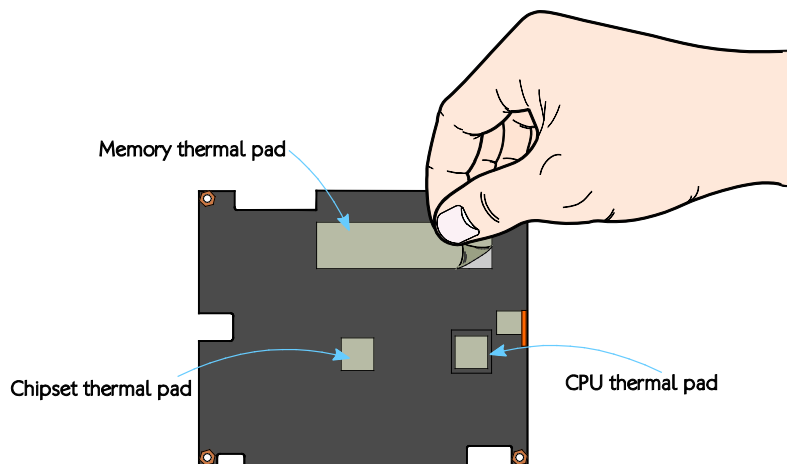

Figure 16: Removing the thermal pad cover

Step 6

Gently install the heatsink/heat spreader. Make sure to install it in the correct orientation. The thermal pads underneath the heatsink/heat spreader should be located above the memory and chipset.

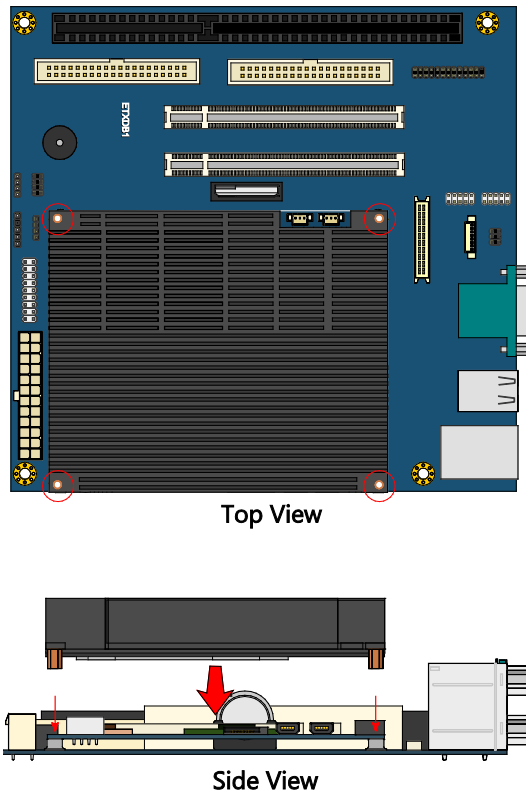

Figure 17: Installing the heatsink/heat spreader on the VIA ETX-8X90-10GR module

Step 7

Connect the CPU fan jack to the fan connector (FAN1).

Step 8

Secure the VIA ETX-8X90-10GR module with the heatsink/heat spreader by tightening four M2.5*12 screws in sequence (torque is 2.5~2.6 kgfcm).



Note:

Be sure to follow the sequence shown below when tightening the screws, otherwise it may cause damage to the device.

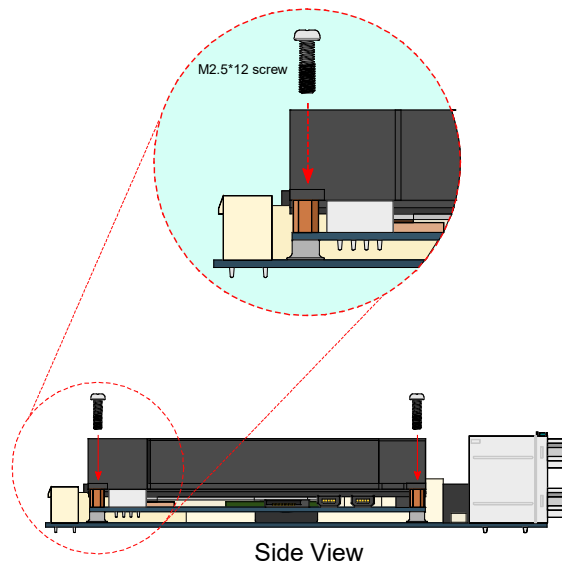
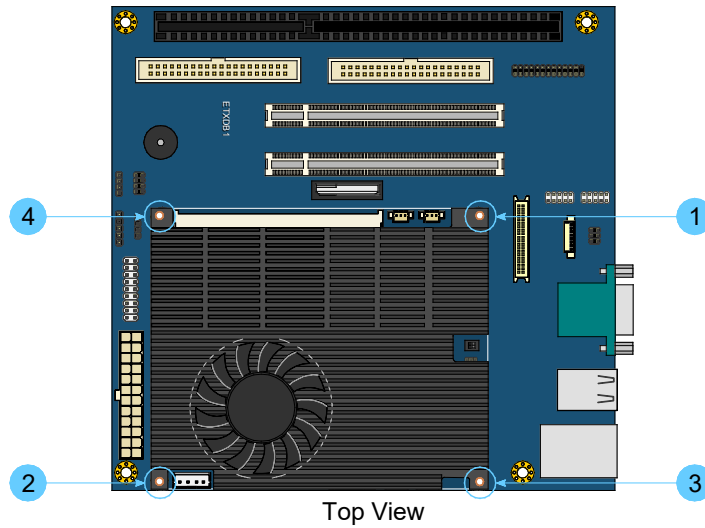

Figure 18: Securing the heatsink/heat spreader and VIA ETX-8X90-10GR module

4. BIOS Setup Utility

4.1. Entering the BIOS Setup Utility

Power on the computer and press **Delete** during the beginning of the boot sequence to enter the BIOS Setup Utility. If the entry point has passed, restart the system and try again.

4.2. Control Keys

- Up** Move up one row
- Down** Move down one row
- Left** Move to the left in the navigation bar
- Right** Move to the right in the navigation bar
- Enter** Access the highlighted item / Select the item
- Esc** Jumps to the Exit screen or returns to the previous screen
- Page up / +¹** Increase the numeric value
- Page down / -¹** Decrease the numeric value
- F1** General help²
- F10** Save all the changes and exit

**Notes:**

1. Must be pressed using the 10-key pad.
2. The General help contents are only for the Status Page and Option Page setup menus.

4.3. Navigating the BIOS Menus

The main menu displays all the BIOS setup categories. Use the <Left>/<Right> and <Up>/<Down> arrow keys to select any item or sub-menu. Descriptions of the selected/highlighted category are displayed at the bottom of the screen.

The small triangular arrowhead symbol next to a field indicates that a sub-menu is available (see figure below). Press <Enter> to display the sub-menu. To exit the sub-menu, press <Esc>.

4.4. Getting Help

The BIOS Setup Utility provides a "General Help" screen. This screen can be accessed at any time by pressing **F1**. The help screen displays the keys for using and navigating the BIOS Setup Utility. Press **Esc** to exit the help screen.

4.5. System Overview

The System Overview screen is the default screen that is shown when the BIOS Setup Utility is launched. This screen can be accessed by traversing the navigation bar to the “Main” label.

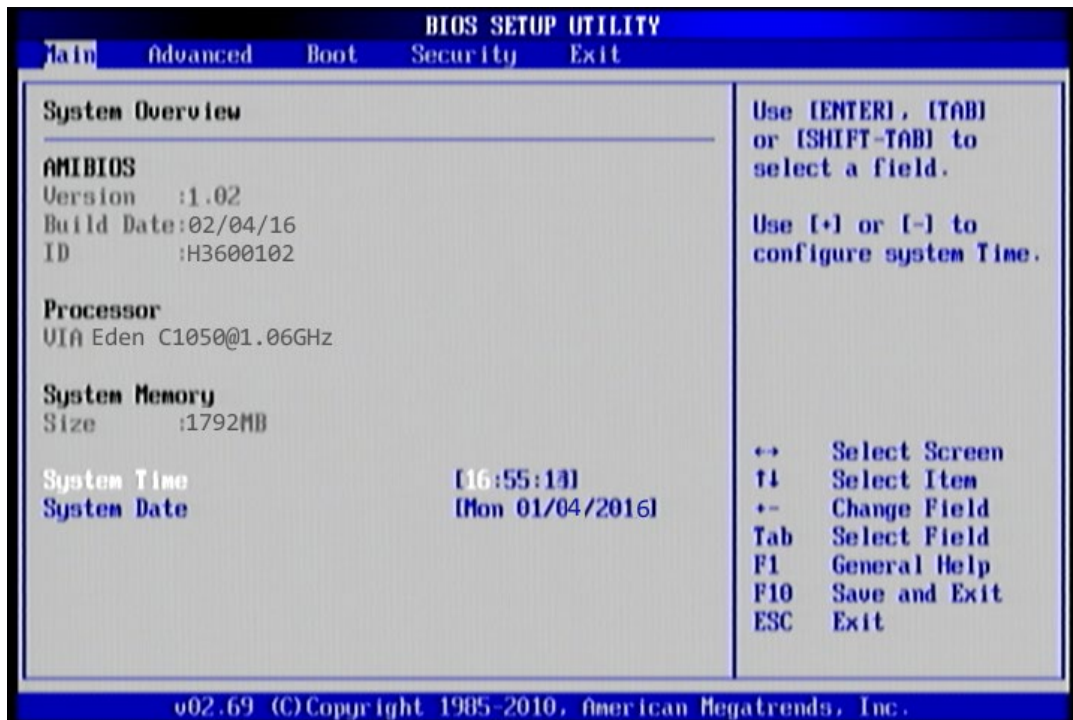

Figure 19: Illustration of the Main menu screen

4.5.1. AMIBIOS

The content in this section of the screen shows the current BIOS version, build date, and ID number.

4.5.2. Processor

This content in this section shows the CPU information that has been detected.

4.5.3. System Memory

This section shows the amount of available memory that has been detected.

4.5.4. System Time

This section shows the current system time. Press **Tab** to traverse right and **Shift+Tab** to traverse left through the hour, minute, and second segments. The **+** and **-** keys on the number pad can be used to change the values. The time format is [Hour : Minute : Second].

4.5.5. System Date

This section shows the current system date. Press **Tab** to traverse right and **Shift+Tab** to traverse left through the month, day, and year segments. The **+** and **-** keys on the number pad can be used to change the values. The weekday name is automatically updated when the date is altered. The date format is [Weekday, Month, Day, Year].

4.6. Advanced Settings

The Advanced Settings screen shows a list of categories that can provide access to a sub-screen. Sub-screen links can be identified by the preceding right-facing arrowhead.

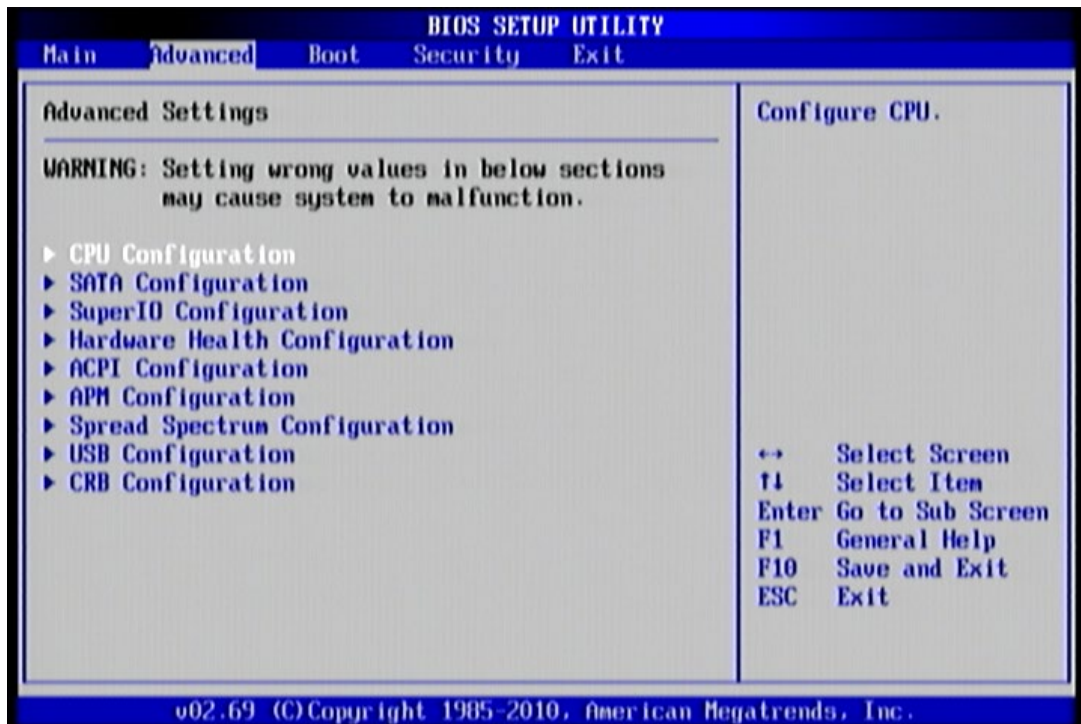

Figure 20: Illustration of the Advanced Settings screen

The Advanced Settings screen contains the following links:

- CPU Configuration
- SATA Configuration
- SuperIO Configuration
- Hardware Health Configuration
- ACPI Configuration
- APM Configuration
- Spread Spectrum Configuration
- USB Configuration
- CRB Configuration

4.6.1. CPU Configuration

The CPU Configuration screen shows detailed information about the built-in processor.

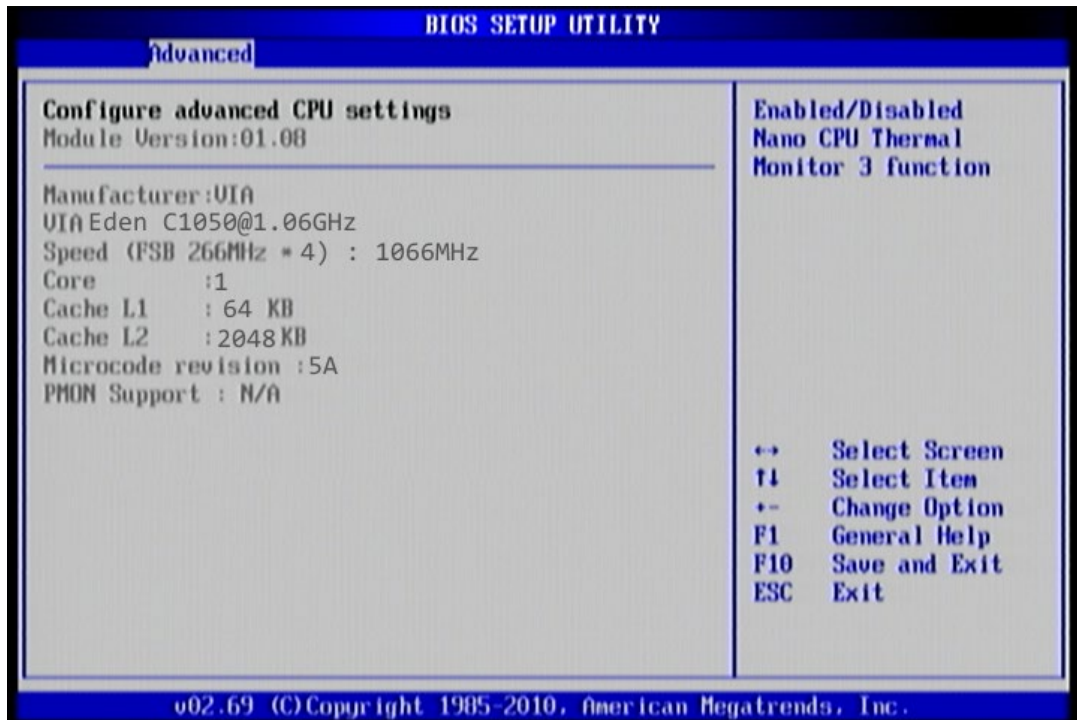

Figure 21: Illustration of the CPU Configuration screen

4.6.2. SATA Configuration

The SATA Configuration screen shows links to the primary and secondary IDE hard drive information screens.

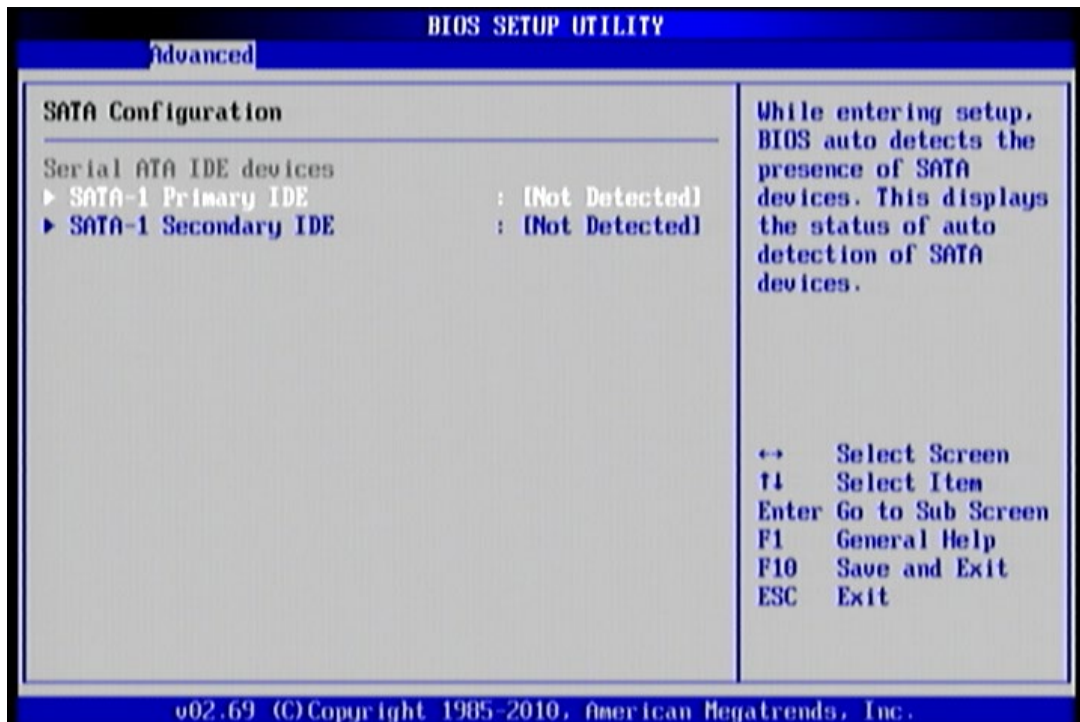

Figure 22: Illustration of the SATA Configuration screen

4.6.2.1. Hard Disk Information

When a hard drive is detected, the hard drive's detailed information can be displayed on the SATA-1 Primary/Secondary IDE sub-screen.

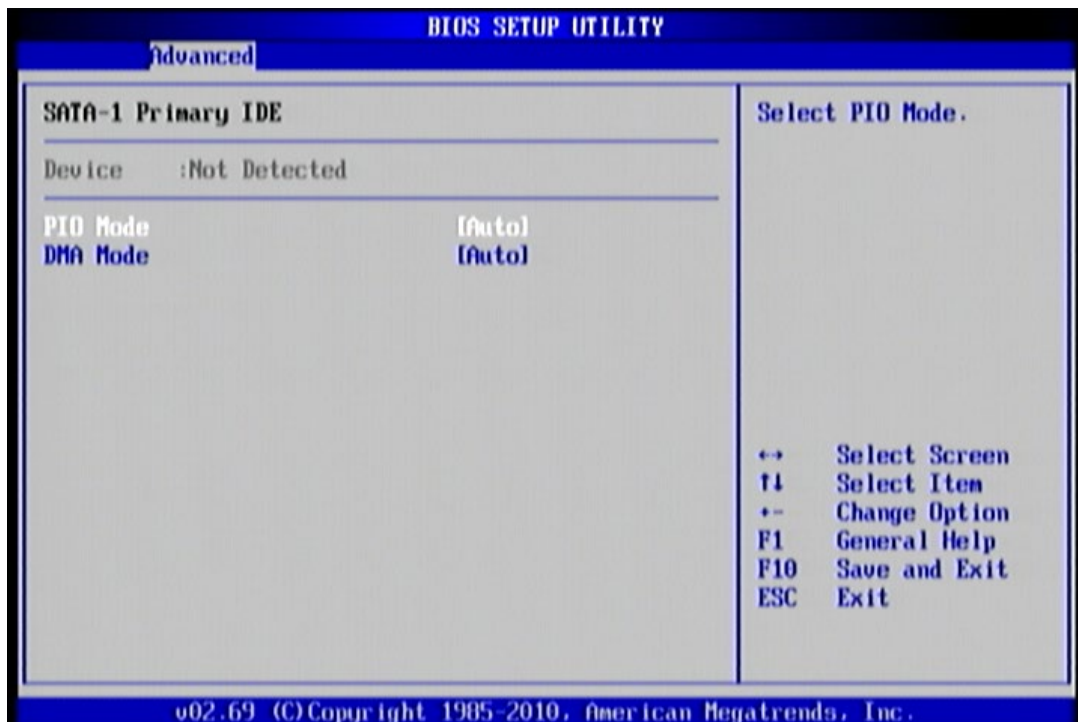

Figure 23: Illustration of the SATA-1 Primary IDE screen

In addition, the PIO and DMA modes may be configured for each SATA hard drive.

4.6.2.1.1. PIO Mode

The PIO Mode has six possible settings: Auto, 0, 1, 2, 3, and 4. The "Auto" setting enables the BIOS to autonomously determine the appropriate PIO mode for the hard drive. If a manual setting is preferred, then be sure the correct PIO mode of the hard drive is used. It is not recommended to set the PIO mode higher than what the hard drive manufacturer states.

4.6.2.1.2. DMA Mode

The DMA Mode has four possible settings: Auto, SWDMAn, MWDMAn and UDMAn. If a manual setting is preferred, then be sure the correct DMA mode of the hard drive is used.

Auto

The "Auto" setting enables the BIOS to automatically detect DMA mode.

SWDMAn

Single Word DMA mode.

MWDMAn

Multi Word DMA mode.

UDMAn

Ultra DMA mode.

4.6.3. SuperIO Configuration

The SuperIO Configuration screen shows the specific addresses, IRQs and types of the onboard serial ports.

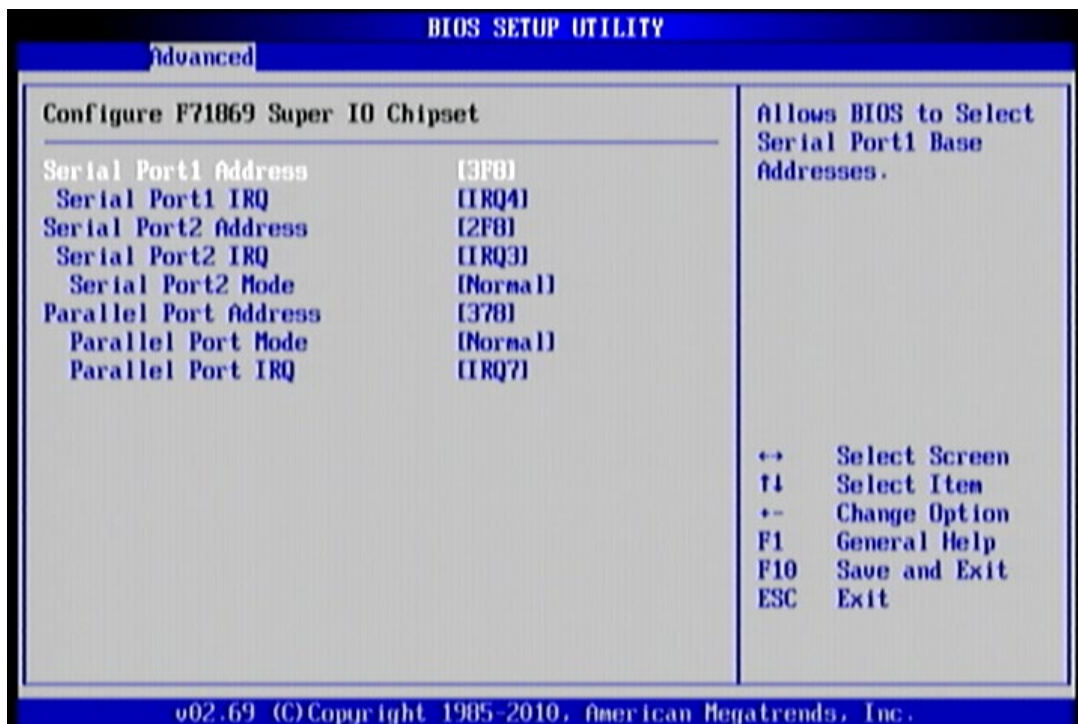

Figure 24: Illustration of the SuperIO Configuration screen

4.6.3.1. Serial Ports 1 to 2 Address and IRQ

This option allows the user to select the Serial Port 1 and 2 base I/O address and interrupt request address. The Serial Port 1 to 2 has selectable options.

Port	Address	IRQs
1	3F8, Disabled	IRQ3, IRQ4, IRQ10, IRQ11
2	2F8, Disabled	IRQ3, IRQ4, IRQ10, IRQ11

Table 12: Serial port addresses and IRQs

4.6.3.2. Serial Port 2 Mode

This specifies the serial port mode. The serial port mode has three options: Normal, IrDA (1.6 μ s) and IrDA (3/16 bit)

4.6.3.3. Parallel Port Address

This specifies the I/O port address and IRQ of the parallel port. The parallel port has four options: Disabled and 378.

4.6.3.4. Parallel Port Mode

This specifies the parallel port mode. The parallel port mode has five options: Normal, Bi-Directional, ECP, EPP, ECP+EPP.

4.6.3.5. Parallel Port IRQ

This specifies the parallel port interrupt request address. The parallel port IRQ has 2 options: IRQ5 and IRQ7.

4.6.4. Hardware Health Configuration

The Hardware Health Configuration screen displays the monitored aspects of the module such as CPU temperature, system temperature, fan speeds, and voltages of the power planes.

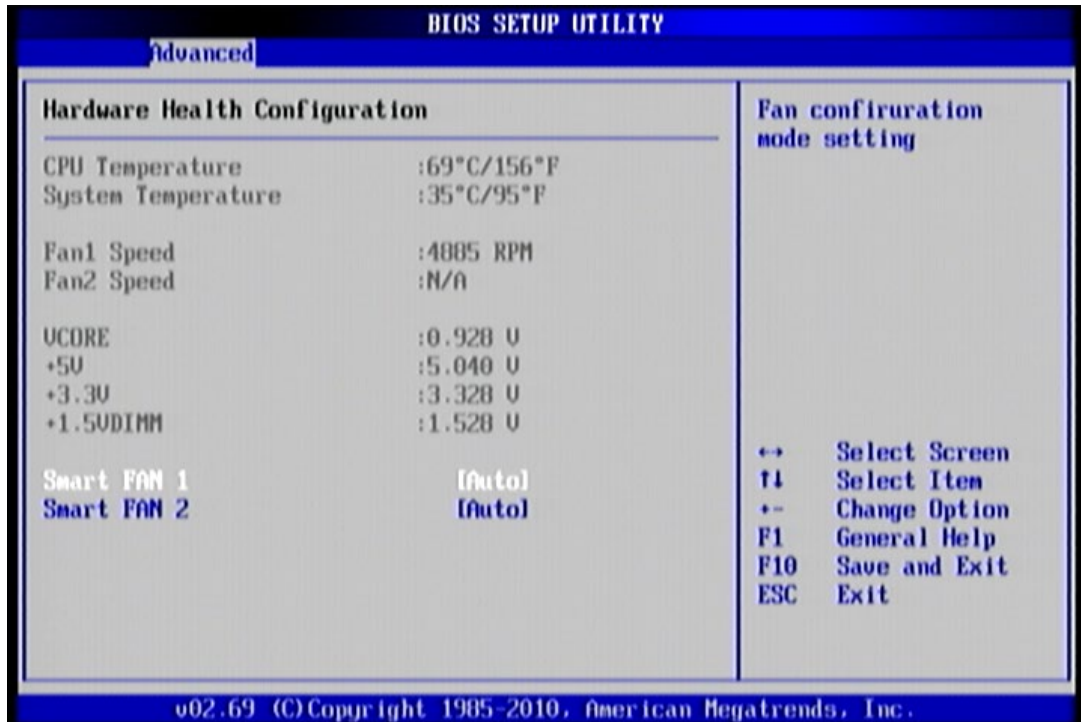

Figure 25: Illustration of the Hardware Health Configuration screen

4.6.4.1. Smart FAN 1 and FAN 2

The Smart FAN features have two options: Auto and Full Speed. The "Auto" option enables the BIOS to adjust the fan speed according to the needs of the CPU and system. The "Full Speed" option forces the fans to run at their maximum RPM.

4.6.5. ACPI Configuration

ACPI grants the operating system direct control over system power management. The ACPI Configuration screen can be used to set a number of power management related functions.

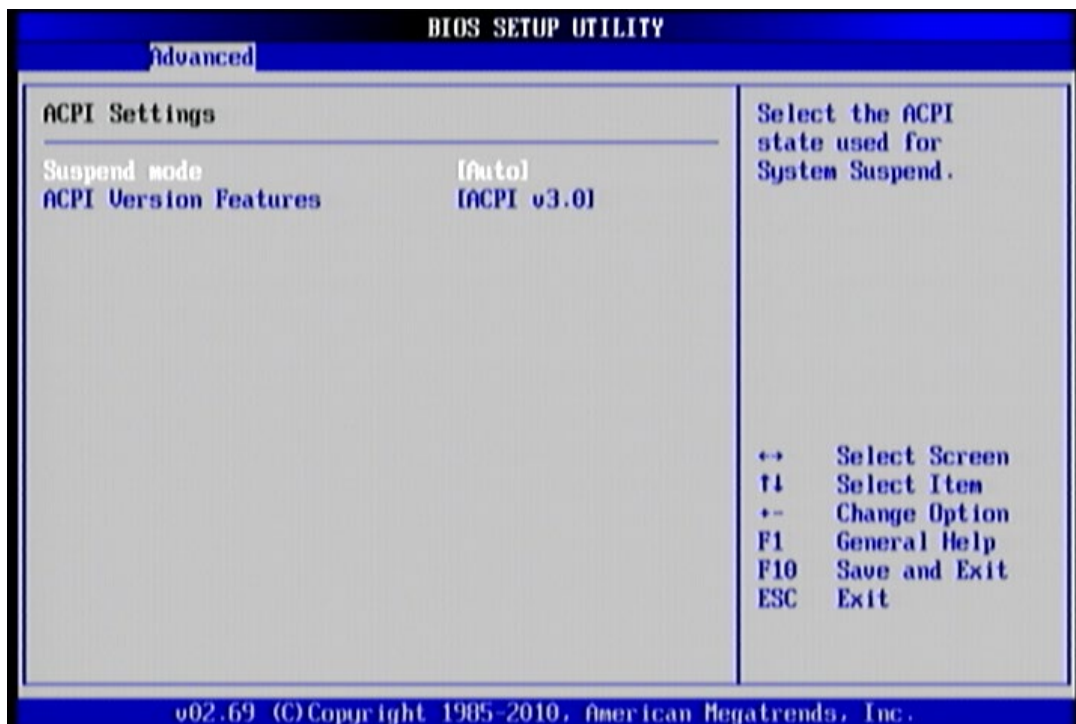

Figure 26: Illustration of the ACPI Configuration screen

4.6.5.1. Suspend Mode

The Suspend Mode field has three selectable options.

S1(POS)

S1/Power On Suspend (POS) is a low power state. In this state, no system context (CPU or chipset) is lost and hardware maintains all system contexts.

S3(STR)

S3/Suspend To RAM (STR) is a power-down state. In this state, power is supplied only to essential components such as main memory and wakeup-capable devices. The system context is saved to main memory, and context is restored from the memory when a "wakeup" event occurs.

Auto

When the Suspend Mode is set to Auto, the operating system will control the power state.

4.6.5.2. ACPI Version Features

The ACPI Version Features enables the BIOS to support the designated ACPI specification. There are three versions to choose from: ACPI v1.0, ACPI v2.0, and ACPI v3.0.

4.6.6. APM Configuration

APM enables the operating system to co-work with the BIOS to control the system power management. The APM Configuration screen can be used to set a number of power management functions.

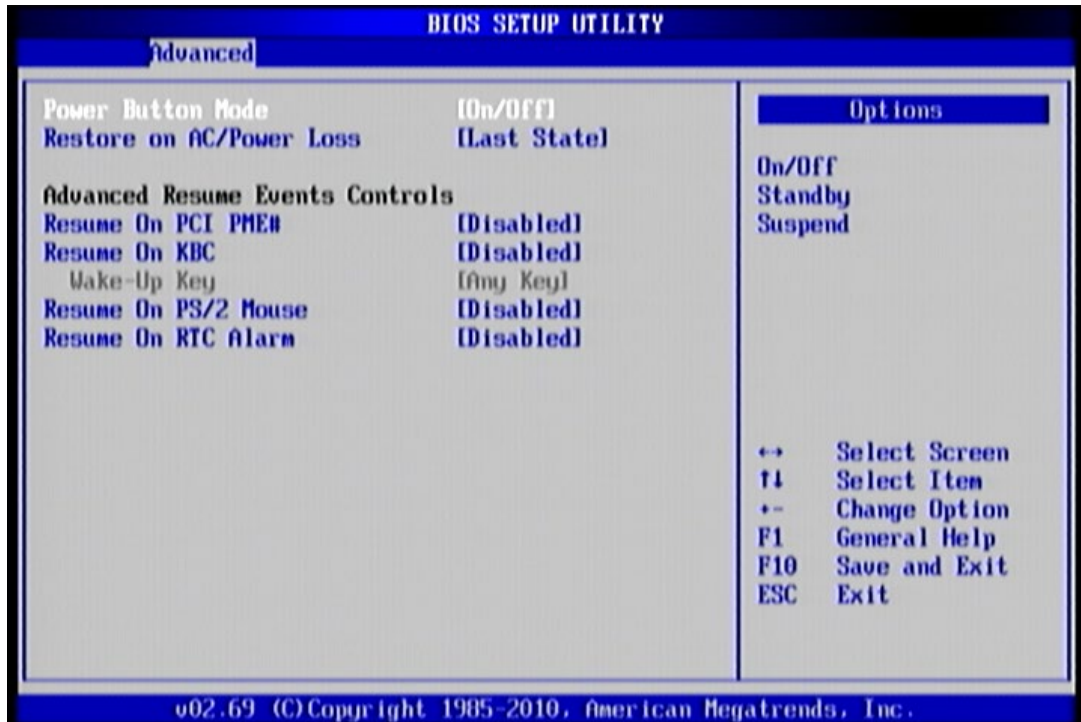

Figure 27: Illustration of the APM Configuration screen

4.6.6.1. Power Button Mode

The Power Button Mode has three options.

On/Off

When On/Off is selected, pressing the power button will instantly cause the system to power on or off.

Standby

When Standby is selected, the power button must be pressed and held down for 4 seconds before the system will power off.

Suspend

When Suspend is selected, pressing the power button will instantly cause the system to enter suspend mode.

4.6.6.2. Restore on AC/Power Loss

Restore on AC/Power Loss defines how the system will respond after AC power has been interrupted while the system is on. There are three options.

Power Off

The Power Off option keeps the system in an off state until the power button is pressed again.

Power On

The Power On option restarts the system when the power has returned.

Last State

The Last State option restores the system to its previous state when the power was interrupted.

4.6.6.3. Resume On PCI PME#

The Resume On PCI PME# feature has two settings: Enabled and Disabled. When the setting is changed to "Enabled", the system will boot if PME event is triggered via PCI devices. When the setting is changed to "Disabled", this feature will not be function.

4.6.6.4. Resume On KBC

Resume on KBC wakes up a system that has been put into suspend or standby mode. When this feature is enabled, keyboard activity as defined in the **Wake-Up Key** feature will cause the system to wake up. This feature has three options.

S3

The S3 option enables keyboard activity to be detected if the system is in S3 power saving mode.

S3/S4/S5

The S3/S4/S5 option enables keyboard activity to be detected if the system is in S3/S4/S5 power saving mode.

Disabled

The Disabled option disables the detection of all keyboard activity.

4.6.6.5. Wake-Up Key

The Wake-Up Key feature can only be set when **Resume on PS/2 KBC** is set to "S3" or "S3/S4/S5". Otherwise, this feature will be not selectable. This feature has two options.

Any Key

The Any Key option enables any key on the keyboard to trigger the Wake-Up event.

Specific Key

The Specific Key option unlocks the **Wake-Up Password** feature.

4.6.6.6. Wake-Up Password

The Wake-Up Password feature can only be set when the **Wake-Up Key** feature is set to "Specific Key". This feature enables the user to specify a key sequence that must be entered in order to wake up the system.

The key sequence can consist of up to 6 alphanumeric characters and some special characters. Function keys and modifier keys (such as Ctrl, Alt, Del, etc.) cannot be used.

4.6.6.7. Resume On PS/2 Mouse

Resume on PS/2 Mouse wakes up a system that has been put into suspend or standby mode. When this feature is enabled, any PS/2 mouse activity that is detected will cause the system to wake up. This feature has three options.

S3

The S3 option enables any PS/2 mouse activity to be detected if the system is in S3 power saving mode.

S3/S4/S5

The S3/S4/S5 option enables any PS/2 mouse activity to be detected if the system is in S3/S4/S5 power saving mode.

Disabled

The Disabled option disables the detection of all PS/2 mouse activity.

4.6.6.8. Resume on RTC Alarm

This feature enables the BIOS to automatically power on the system at a scheduled time. When enabled, the **RTC Alarm Date** and **System Time** features will be unlocked.

4.6.6.9. RTC Alarm Date (Days)

The RTC Alarm Date feature is visible only when **Resume on RTC Alarm** is enabled. This feature enables the user to specify a specific date each month or daily recurrence. Use the + and - keys on the number pad to change the value of the RTC Alarm Date.

Every Day

The Every Day option triggers the RTC Alarm daily.

1 – 31

When a specific numeric date is selected, the RTC Alarm will be triggered on that day of the month.

4.6.6.10. System Time

The System Time option enables the user to specify the time the system should power on for the date that is set in **RTC Alarm Date**.

4.6.7. Spread Spectrum Configuration

The Spread Spectrum Configuration screen enables access to the CPU Spread Spectrum Setting feature.

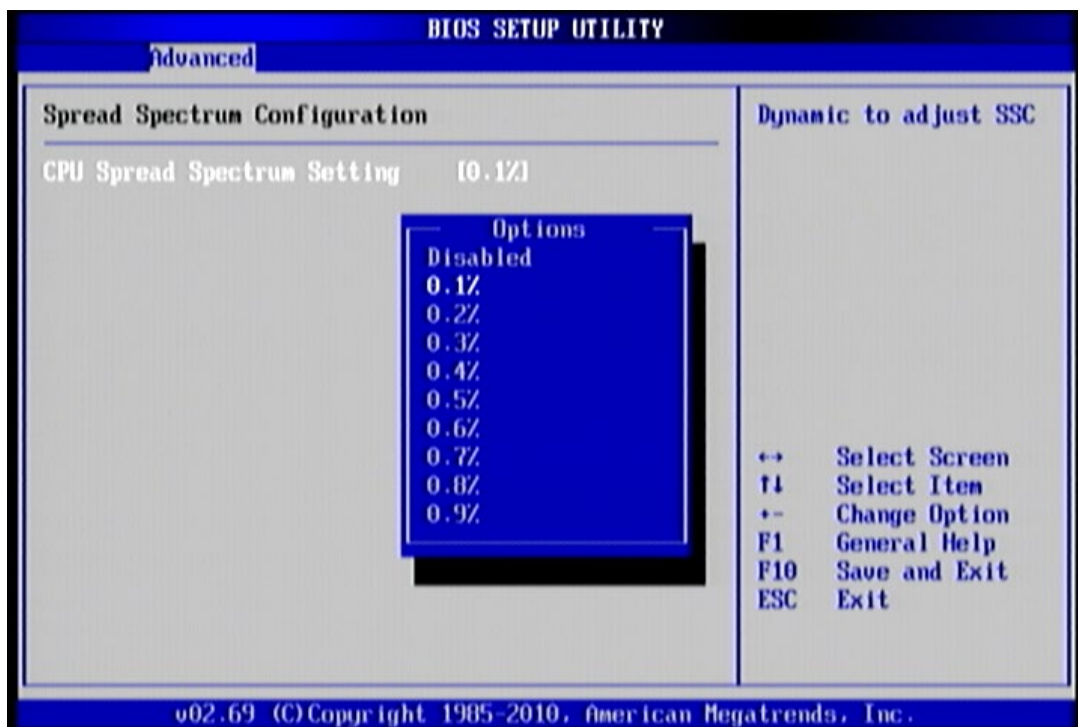

Figure 28: Illustration of the Spread Spectrum Configuration screen

4.6.7.1. CPU Spread Spectrum Setting

The CPU Spread Spectrum Setting feature enables the BIOS to modulate the clock frequencies originating from the module. The settings are in percentages of modulation. Higher percentages result in greater modulation of clock frequencies. This feature has settings that range from 0.1% to 0.9%.

4.6.8. USB Configuration

The USB Configuration screen shows the number of connected USB devices. Additionally, support for various USB features can be enabled or disabled.

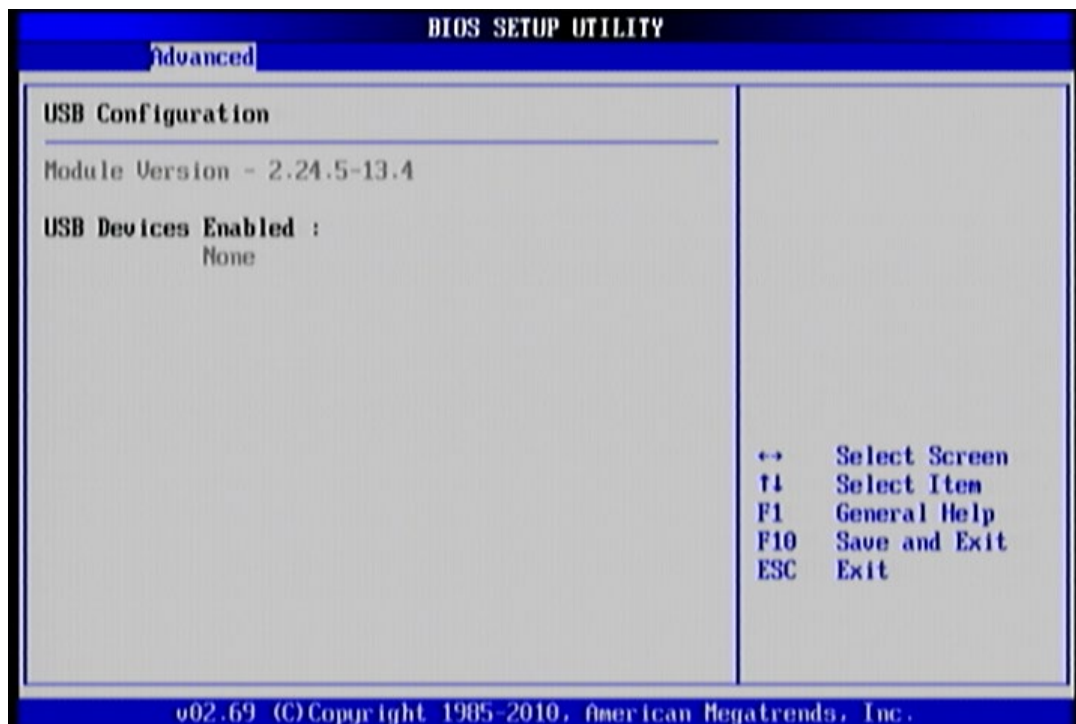

Figure 29: Illustration of the USB Configuration screen

4.6.9. CRB Configuration

The CRB Configuration screen includes several chipset settings.

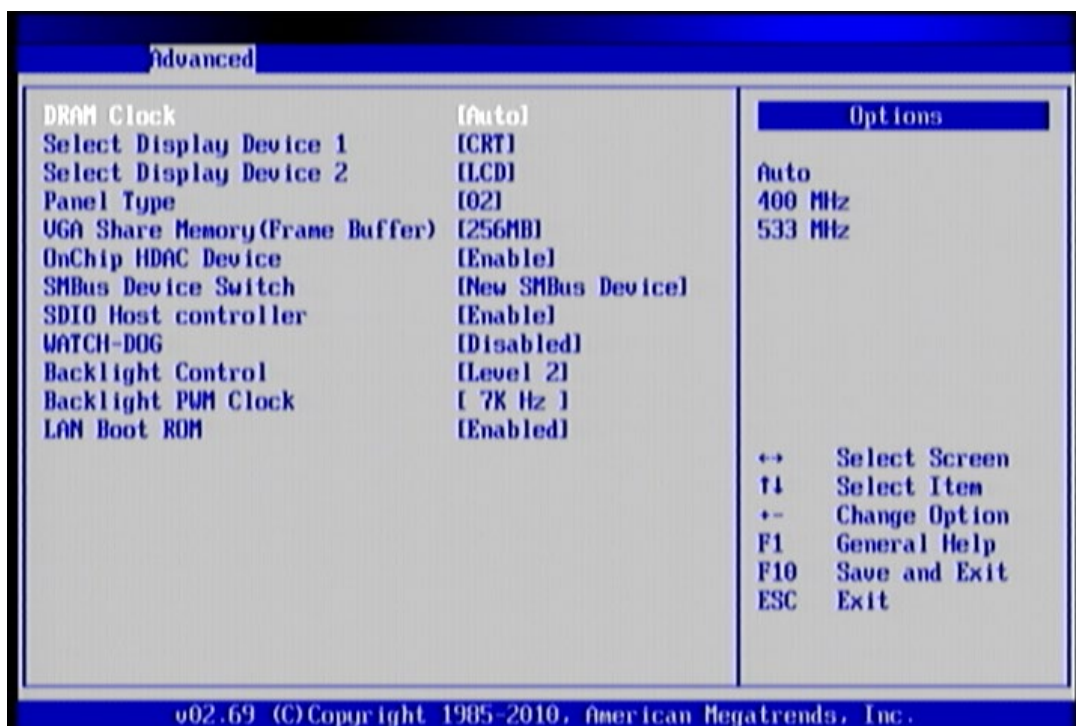

Figure 30: Illustration of the CRB Configuration screen

4.6.9.1. DRAM Clock

The DRAM Clock feature enables the user to determine how the BIOS handles the memory clock frequency. The memory clock can either be dynamic or static. This feature has three options.

Auto

The Auto option enables the BIOS to select a compatible clock frequency for the installed memory.

400 MHz

The 400 MHz option forces the BIOS to be fixed at 800 MHz for DDR3 memory modules.

533 MHz

The 533 MHz option forces the BIOS to be fixed at 1066 MHz for DDR3 memory modules.

4.6.9.2. Select Display Device 1 and 2

The Select Display Device feature enables the user to choose a specific display interface. This feature has two options: CRT and LCD.

4.6.9.3. Panel Type

This feature enables the user to specify the resolution of the display being used with the system. The panel types are predefined in the VGA VBIOS.

Panel Type	Resolution	Panel Type	Resolution
00	640 × 480	08	800 × 480
01	800 × 600	09	1024 × 600
02	1024 × 768	10	1366 × 768
03	1280 × 768	11	1600 × 1200
04	1280 × 1024	12	1680 × 1050
05	1400 × 1050	13	User define
06	1440 × 900	14	User define
07	1280 × 800	15	User define

Table 13: Panel types resolution

4.6.9.4. VGA Share Memory (Frame Buffer)

The VGA Share Memory feature enables the user to choose the amount of the system memory to reserve for use by the integrated graphics controller. The amount of memory options are: 128 MB, 256 MB and 512 MB.

4.6.9.5. OnChip HDAC Device

The OnChip HDAC Device feature enables the BIOS to control the high definition audio codec in the chipset. This feature has two options: enable and disable.

4.6.9.6. SMBus Device Switch

This feature enables support for the new chipset definition of the SMBus interface. There are two options: New SMBus Device and Old SMBus Device. If the OS cannot support the new SMBus definition, then change the setting to "Old SMBus Device".

4.6.9.7. SDIO Host controller

The SDIO Host controller feature has two options: Enabled and Disabled.

4.6.9.8. WATCH-DOG

The WATCHDOG Timer Enable feature unlocks two other features that enable the BIOS to monitor the state of the system. This feature has two options: enabled or disabled.

4.6.9.9. Unit-Select

The Unit-Select feature is only available if the **WATCH-DOG** feature has been enabled. This feature has two options: minutes and seconds.

4.6.9.10. Time-Select

The Time-Select is only available if the **WATCH-DOG** feature has been enabled. This feature requires the user to input an integer in the range of 0–255 if the **Unit-Select** feature is set to “Seconds”. If the **Unit-Select** feature is set to “Minutes”, then the user can only input an integer in the range of 0–17. If the user inputs “0”, the **WATCH-DOG** feature will be disabled regardless of the setting for **Unit-Select**.

4.6.9.11. Backlight Control

The Backlight Control feature enables the user to control the brightness of the LCD backlight. This feature has four options.

Level 1 25% Light

Level 2 50% Light

Level 3 75% Light

Level 4 100% Light

4.6.9.12. Backlight PWM Clock

The Backlight PWM Clock feature enables the user to correct the LCD backlight PWM clock. This feature has four options: 14 KHz, 7 KHz, 110 Hz, 54.4 Hz.

4.6.9.13. LAN Boot ROM

The LAN Option ROM feature has two options: Enabled and Disabled. If the LAN Boot ROM feature is enabled, then the system will load a separate ROM for the LAN controller in order to boot through the LAN Ethernet. When the setting is changed to “Disabled”, the system does not load a separate ROM from the LAN controller.

4.7. Boot Settings

The Boot Settings screen has two links that goes to the **Boot Settings Configuration** and **Boot Device Priority** screens.

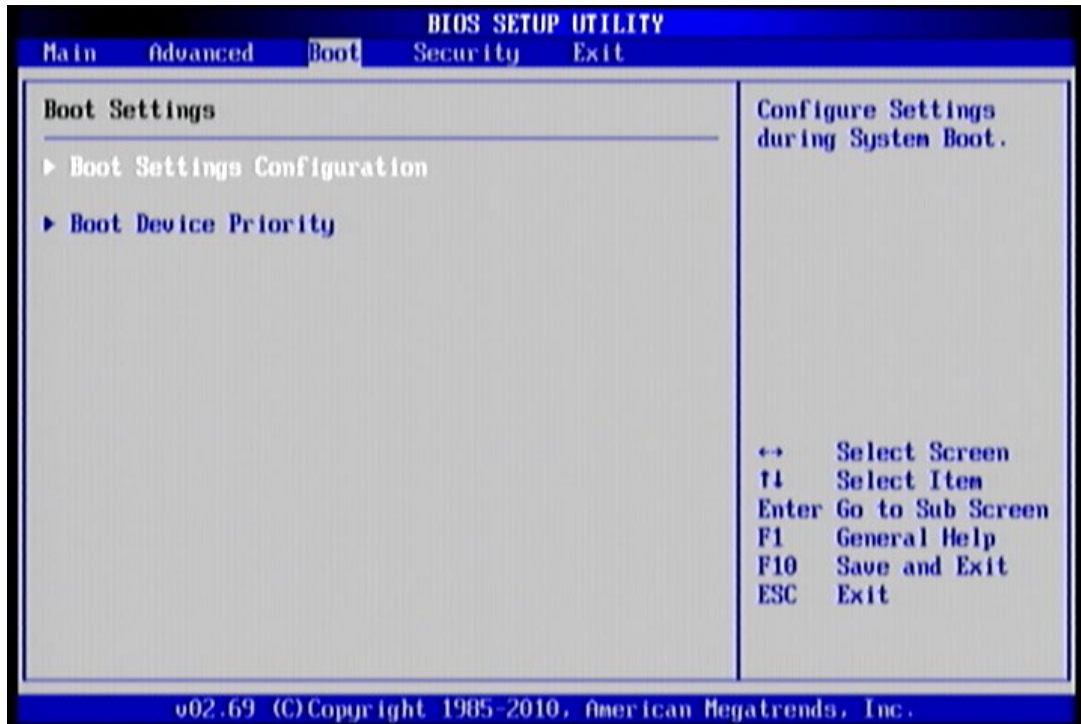

Figure 31: Illustration of the Boot Settings screen

4.7.1. Boot Settings Configuration

The Boot Settings Configuration screen has several features that can be run during the system boot sequence.

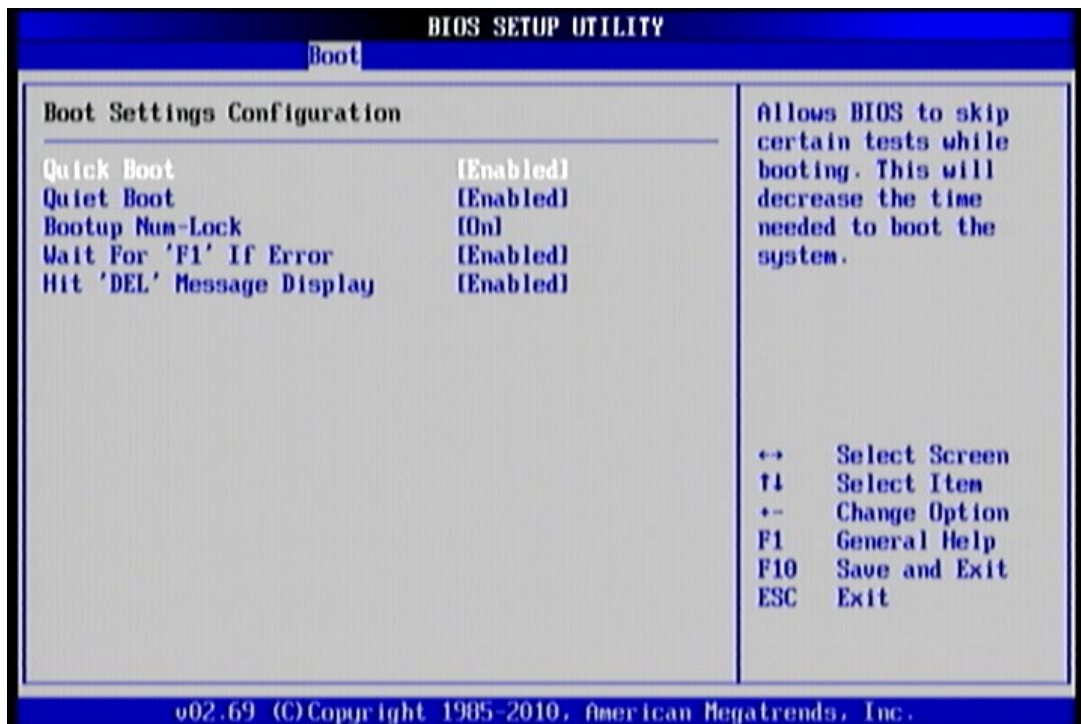

Figure 32: Illustration of the Boot Settings Configuration screen

4.7.1.1. Quick Boot

The Quick Boot feature enables the BIOS to skip certain tests in order to speed up the boot sequence. This feature has two options: "Enabled" and "Disabled".

4.7.1.2. Quiet Boot

The Quiet Boot feature hides all of the Power-on Self Test (POST) messages during the boot sequence. Instead of the POST messages, the user will see an OEM logo. This feature has two options: enabled and disabled.

4.7.1.3. Bootup Num-Lock

The Bootup Num-Lock feature determines how the 10-key pad will behave. When the feature is enabled, the 10-key pad will behave as a number pad. When the feature is disabled, the 10-key pad will behave as cursor navigation keys.

4.7.1.4. Wait for 'F1' if Error

This feature determines how the system will respond if an error is detected during the boot sequence. If this feature is enabled, the BIOS will pause booting and wait for the user to press F1 to enter the BIOS setup menu. This feature has two options: enabled and disabled.

4.7.1.5. Hit 'DEL' Message Display

This feature determines if the BIOS will display a POST message that informs the user how to access the BIOS Setup Utility. This feature has two options: enabled and disabled.



Note:

If the Quiet Boot option is enabled, the settings of this feature will have no effect.

4.7.2. Boot Device Priority

The Boot Device Priority screen lists all bootable devices.

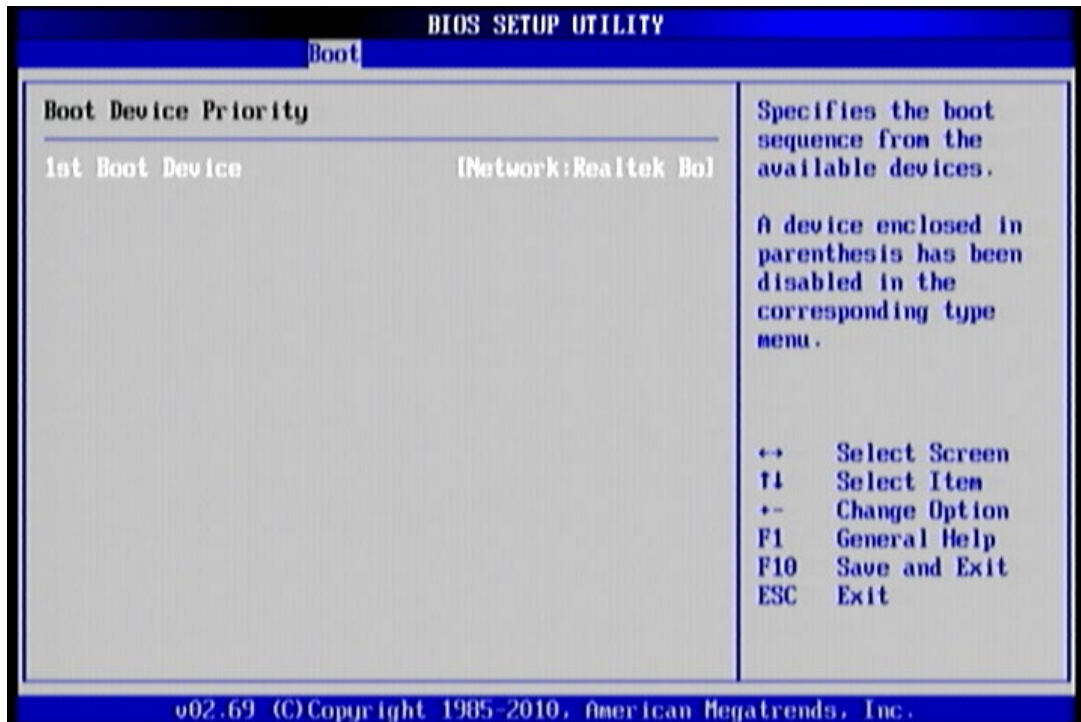

Figure 33: Illustration of Boot Device Priority screen

4.7.2.1. 1st Boot Device

This feature specifies the boot sequence from the available devices. The available boot devices are detected dynamically and bootable devices will be listed accordingly. This feature has two options: [Network: Realtek Boot Agent and Disabled]

4.8. Security Settings

The Security Settings screen provides a way to restrict access to the BIOS or even the entire system.

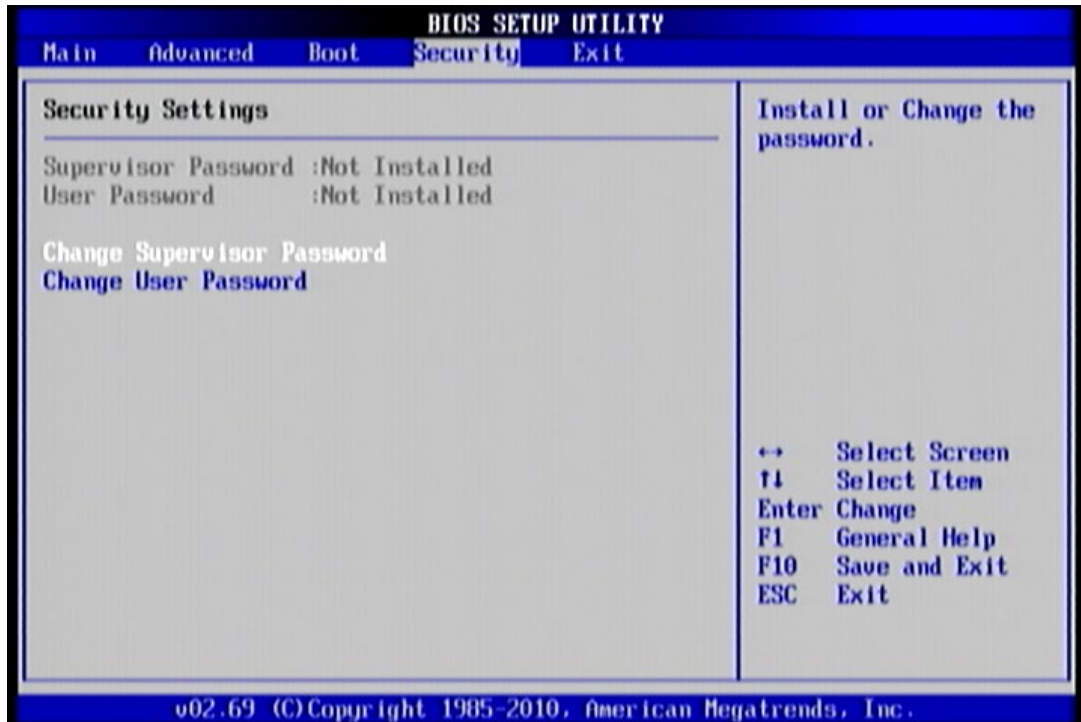

Figure 34: Illustration of the Security Settings screen

4.8.1. Change Supervisor Password

This option is for setting a password for accessing the BIOS setup utility. When a password has been set, a password prompt will be displayed whenever the BIOS setup utility is launched. This prevents an unauthorized person from changing any part of the system configuration.

When a supervisor password is set, the **Password Check** option will be unlocked.

4.8.2. User Access Level

This feature controls the level of access a user (without the supervisor password) is granted to the BIOS setup utility. This feature has four options.

No Access

The No Access option completely locks the BIOS setup utility. The supervisor password is required to access and change the BIOS settings.

View Only

The View Only option only allows access to view the BIOS settings. Users with this permission level cannot make changes to the BIOS.

Limited

The Limited option only allows non-critical BIOS settings to be changed. Changes are allowed to the following BIOS features:

- System Time
- System Date
- Quick Boot
- Display Logo

Full Access

The Full Access option allows all BIOS settings to be changed except for the Change Supervisor Password and User Access Level options.

4.8.3. Change User Password

This option is for setting a password for non-supervisors. When a user password is set, the **Clear User Password** and **Password Check** options will be unlocked.

4.8.4. Clear User Password

This option is only available when the user accesses the BIOS Setup Utility when the user password has been specified.

4.8.5. Password Check

This feature is compulsory when the **Change Supervisor Password** option is set. The user will have up to three chances to enter the correct password before the BIOS forces the system to stop booting. If the user does not enter the correct password, the keyboard will also lock up. The only way to get past this is to do a hard reboot (i.e., use the system reset button or cut off the power to the system). A soft reboot (i.e., Ctrl+Alt+Del) will not work because the keyboard will be locked. This feature has two options.

Setup

The Setup option forces users to enter a password in order to access the BIOS Setup Utility.

Always

The Always option forces users to enter a password in order to boot up the system.

4.9. Exit Options

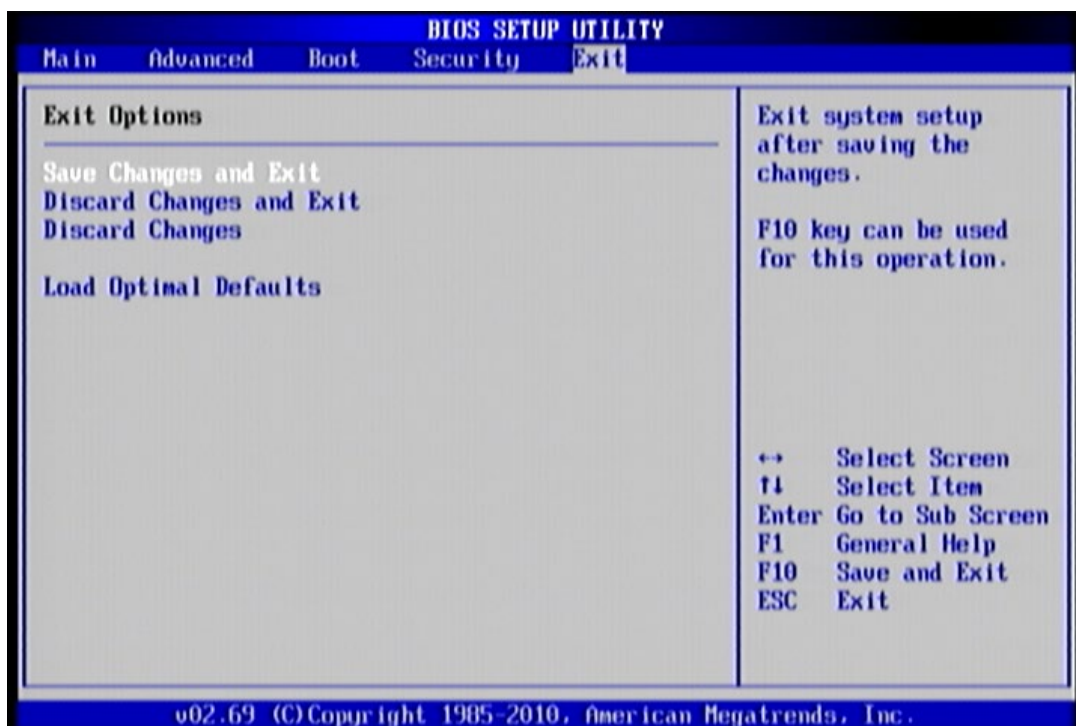

Figure 35: Illustration of the Exit Options screen

4.9.1. Save Changes and Exit

Save all changes to the BIOS and exit the BIOS Setup Utility. The “F10” hotkey can also be used to trigger this command.

4.9.2. Discard Changes and Exit

Exit the BIOS Setup Utility without saving any changes. The “Esc” hotkey can also be used to trigger this command.

4.9.3. Discard Changes

This command reverts all changes to the settings that were in place when the BIOS Setup Utility was launched.

4.9.4. Load Optimal Defaults

Load optimal default values for all the setup items. The default optimized values are defined by the board manufacturer to provide optimized environment for a basic system.

5. Software and Technical Support

5.1. Microsoft and Linux Support

The VIA ETX-8X90-10GR module is compatible with Microsoft Windows and Linux operating systems.

5.1.1. Driver Installation

Microsoft Driver Support

The latest Windows drivers can be downloaded from the VIA website at www.viatech.com

Linux Driver Support

Linux drivers are provided through various methods including:

- Drivers provided by VIA
- Using a driver built into a distribution package
- Visiting www.viatech.com for the latest updated drivers
- Installing a third party driver (such as the ALSA driver from the Advanced Linux Sound Architecture project for integrated audio)

5.2. Technical Support and Assistance

- For utilities downloads, latest documentation and new information about the VIA ETX-8X90-10GR, please visit our website at <http://www.viatech.com/en/boards/modules/etx-8x90-10gr/>
- For technical support and additional assistance, always contact your local sales representative or board distributor, or go to <https://www.viatech.com/en/support/driver-support-faq/technical-support/> for technical support.
- For OEM clients and system integrators developing a product for long term production, other code and resources may also be made available. Please visit our website at <https://www.viatech.com/en/about/> to submit a request.

Appendix A. ETXDB1 Carrier Board Reference

A.1. Board Specifications

Module Name

- ETXDB1

Rear I/O Connector

- 1 x VGA port
- 1 x COM port
- 4 x USB 2.0 ports
- 1 x 10/100Mbps Ethernet port

Onboard Connector and Slot

- 4 x ETX connectors
- 1 x ISA slot (compatible with ISA ETX 3.02)
- 2 x IDE connectors (IDE1 and IDE2)
- 2 x PCI slots (compatible with PCI 2.3, 32bit/33MHz)
- 1 x LVDS panel connector (compatible with TIA/ELA-644)
 - Pixel clock up to 85MHz
 - Supports panel resolution up to WXGA 1366 x 768
 - Supports one or two-channel 18-bit or 24-bit LVDS panel
- 1 x Backlight connector
- 1 x ATX power connector
- 1 x RTC battery slot

Onboard Pin Header

- 1 x LPT pin header
- 1 x Keyboard and Mouse pin header
- 1 x COM pin header
- 1 x Front Panel pin header (for HDD LED, Power LED, Switch and Speaker)
- 1 x Front Audio pin header
- 1 x SMBus pin header
- 1 x I²C bus pin header
- 1 x SIR pin header

Onboard Jumper and Switch

- 1 x Backlight and Panel Power jumper

Onboard Speaker

- 1 x Buzzer speaker

Form Factor and Dimensions

- Mini-ITX
- 17cm x 17cm (6.7" x 6.7")

Operating Temperature

- 0°C ~ 60°C

Operating and Storage Humidity

- 95% relative humidity

A.1.1. Board Storage Channel Configuration

	ETXDB1 (Carrier Board)		VIA ETX-8X90-10GR (Computer-On-Module)
	IDE1	IDE2	SATA2
Default settings	Enable	Disable	Enable
Manufacturing option	Enable	Enable	Disable

Table 14: ETXDB1 and VIA ETX-8X90-10GR storage configuration

A.2. External I/O Connectors

The ETXDB1 has a wide selection of interfaces. It includes a selection of frequently used ports and connectors as part of the external I/O coastline.

A.2.1. Rear I/O Ports

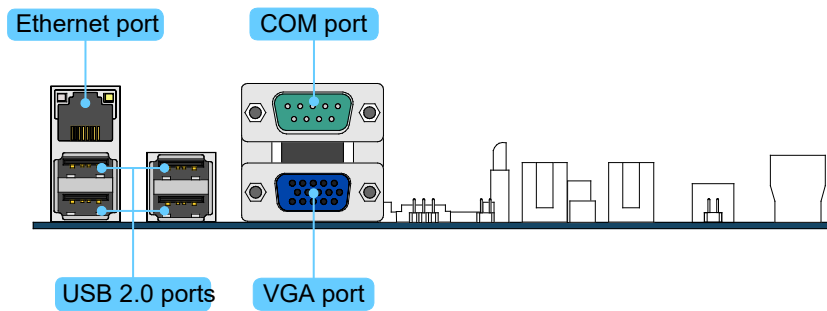

Figure 36: Rear I/O ports

A.3. ETXDB1 Layout Diagram

A.3.1. Onboard Connectors and Slots

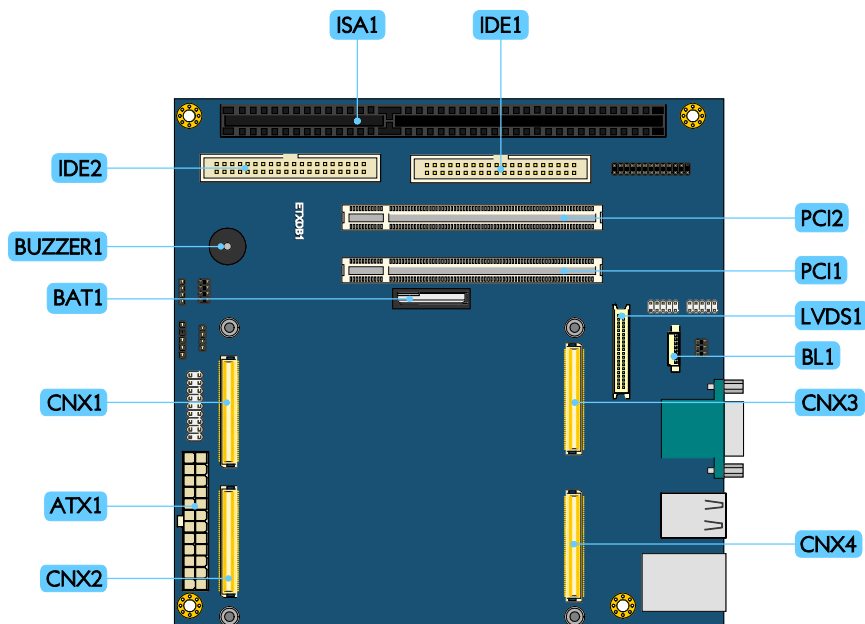

Figure 37: ETXDB1 connectors and slots diagram

Item	Description
ISA1	ISA slot
IDE2	IDE connector 2
BUZZER1	Buzzer speaker
BAT1	RTC battery
CNX1	ETX connector X1
ATX1	20-pin ATX power connector
CNX2	ETX connector X2
CNX4	ETX connector X4
CNX3	ETX connector X3
BL1	Backlight connector
LVDS1	LVDS panel connector
PCI1	PCI slot 1
PCI2	PCI slot 2
IDE1	IDE connector 1

Table 15: Description table of the ETXDB1 connectors and slots

A.3.2. Onboard Pin headers and Jumpers

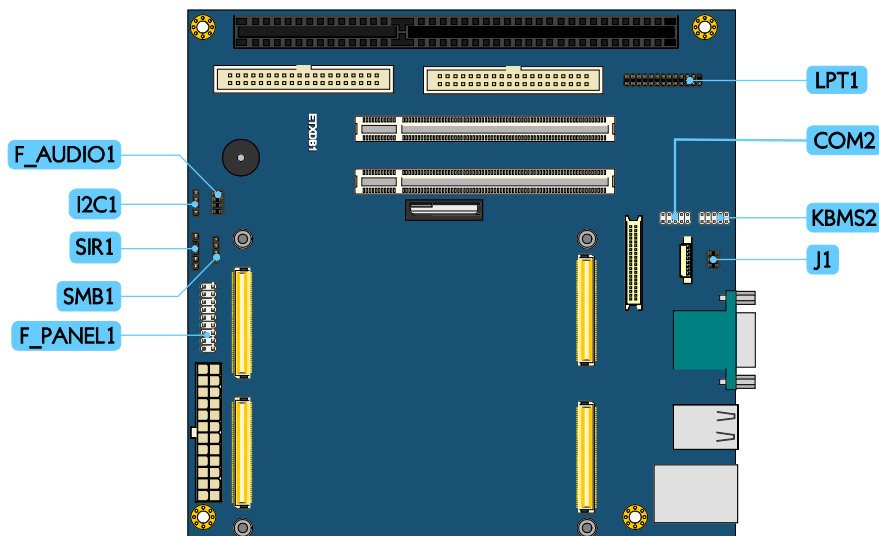

Figure 38: ETXDB1 pin headers and jumpers diagram

Item	Description
F_AUDIO1	Front audio pin header
I2C1	I ² C pin header
SIR1	Serial Infrared pin header
SMB1	System Management Bus (SMBus) pin header
F_PANEL1	Front panel pin header
LPT1	Line Print Terminal pin header
COM2	COM pin header
KBMS2	Keyboard and mouse pin header
J1	Backlight voltage and panel power jumper

Table 16: Description table of the ETXDB1 pin headers and jumpers

A.3.3. Connectors and Slots Pin Definition

A.3.3.1. ATX1 : 20-pin ATX Power Connector

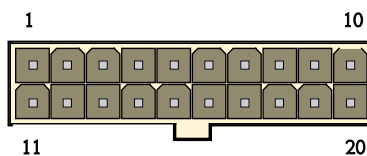

Figure 39: ATX Power connector diagram

Pin	Signal
1	+3.3V
2	+3.3V
3	GND
4	+5V
5	GND
6	+5V
7	GND
8	PW-OK
9	+5VSB
10	+12V
11	+3.3V
12	-12V
13	GND
14	PS-ON
15	GND
16	GND
17	GND
18	-5V
19	+5V
20	+5V

Table 17: ATX Power connector pinouts

A.3.3.2. ISA1 : ISA Slot



Figure 40: ISA slot diagram

Pin	Signal	Pin	Signal	Pin	Signal	Pin	Signal
A1	-IOCHCK	B1	GND	C1	-SBHE	D1	-MEMCS16
A2	SD7	B2	-RSTDRV	C2	LA23	D2	-IOCS16
A3	SD6	B3	+5V	C3	LA22	D3	IRQ10
A4	SD5	B4	IRQ9	C4	LA21	D4	IRQ11
A5	SD4	B5	-5V	C5	LA20	D5	IRQ12
A6	SD3	B6	DREQ2	C6	LA19	D6	ISA_IRQ15
A7	SD2	B7	-12V	C7	LA18	D7	ISA_IRQ14
A8	SD1	B8	-0WS	C8	LA17	D8	-DACK0
A9	SD0	B9	+12V	C9	-MEMR	D9	DREQ0
A10	IOCHRDY	B10	GND	C10	-MEMW	D10	-DACK5
A11	AEN	B11	-SMEMW	C11	SD8	D11	DREQ5
A12	SA19	B12	-SMEMR	C12	SD9	D12	-DACK6
A13	SA18	B13	-IOW	C13	SD10	D13	DREQ6
A14	SA17	B14	-IOR	C14	SD11	D14	-DACK7
A15	SA16	B15	-DACK3	C15	SD12	D15	DREQ7
A16	SA15	B16	DREQ3	C16	SD13	D16	+5V
A17	SA14	B17	-DACK1	C17	SD14	D17	-MASTER
A18	SA13	B18	DREQ1	C18	SD15	D18	GND
A19	SA12	B19	-REFRESH				
A20	SA11	B20	SYS_CLK				
A21	SA10	B21	IRQ7				
A22	SA9	B22	IRQ6				
A23	SA8	B23	IRQ5				
A24	SA7	B24	IRQ4				
A25	SA6	B25	IRQ3				
A26	SA5	B26	-DACK2				
A27	SA4	B27	TC				
A28	SA3	B28	BALE				
A29	SA2	B29	+5V				
A30	SA1	B30	ISA_OSC				
A31	SA0	B31	GND				

Table 18: ISA slot pinouts

A.3.3.3. PCI1 and PCI2: PCI Slots

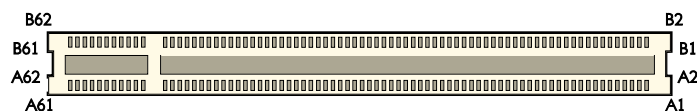

Figure 41: PCI slot diagram

PCI1							
Pin	Signal	Pin	Signal	Pin	Signal	Pin	Signal
A1	NC	A2	+12V	B1	-12V	B2	NC
A3	NC	A4	NC	B3	GND	B4	NC
A5	+5V	A6	-INTA	B5	+5V	B6	+5V
A7	-INTC	A8	+5V	B7	-INTB	B8	-INTD
A9	NC	A10	+5V	B9	NC	B10	NC
A11	NC	A12	GND	B11	NC	B12	GND
A13	GND	A14	+3.3V AUX	B13	GND	B14	NC
A15	-PCIRST	A16	+5V	B15	GND	B16	PCICLK1
A17	-GNT0	A18	GND	B17	GND	B18	-REQ0
A19	-PME	A20	AD30	B19	+5V	B20	AD31
A21	+3.3V	A22	AD28	B21	AD29	B22	GND
A23	AD26	A24	GND	B23	AD27	B24	AD25
A25	AD24	A26	IDSEL	B25	+3.3V	B26	-CBE3
A27	+3.3V	A28	AD22	B27	AD23	B28	GND
A29	AD20	A30	GND	B29	AD21	B30	AD19
A31	AD18	A32	AD16	B31	+3.3V	B32	AD17
A33	+3.3V	A34	-FRAME	B33	-CBE2	B34	GND
A35	GND	A36	-TRDY	B35	-IRDY	B36	+3.3V
A37	GND	A38	-STOP	B37	-DEVSEL	B38	GND
A39	+3.3V	A40	GND	B39	-PLOCK	B40	-PERR
A41	NC	A42	GND	B41	+3.3V	B42	-SERR
A43	PAR	A44	AD15	B43	+3.3V	B44	-CBE1
A45	+3.3V	A46	AD13	B45	AD14	B46	GND
A47	AD11	A48	GND	B47	AD12	B48	AD10
A49	AD9	A50	-	B49	GND	B50	-
A51	-	A52	-CBE0	B51	-	B52	AD8
A53	+3.3V	A54	AD6	B53	AD7	B54	+3.3V
A55	AD4	A56	GND	B55	AD5	B56	AD3
A57	AD2	A58	AD0	B57	GND	B58	AD1
A59	+5V	A60	-P1REQ64	B59	+5V	B60	-P1ACK64
A61	+5V	A62	+5V	B61	+5V	B62	+5V

Table 19: PCI slot 1 pinouts

PCI2							
Pin	Signal	Pin	Signal	Pin	Signal	Pin	Signal
A1	NC	A2	+12V	B1	-12V	B2	NC
A3	NC	A4	NC	B3	GND	B4	NC
A5	+5V	A6	-INTB	B5	+5V	B6	+5V
A7	-INTD	A8	+5V	B7	-INTC	B8	-INTA
A9	NC	A10	+5V	B9	NC	B10	NC
A11	NC	A12	GND	B11	NC	B12	GND
A13	GND	A14	+3.3V AUX	B13	GND	B14	NC
A15	-PCIRST	A16	+5V	B15	GND	B16	PCICLK2
A17	-GNT1	A18	GND	B17	GND	B18	-REQ1
A19	-PME	A20	AD30	B19	+5V	B20	AD31
A21	+3.3V	A22	AD28	B21	AD29	B22	GND
A23	AD26	A24	GND	B23	AD27	B24	AD25
A25	AD24	A26	IDSEL	B25	+3.3V	B26	-CBE3
A27	+3.3V	A28	AD22	B27	AD23	B28	GND
A29	AD20	A30	GND	B29	AD21	B30	AD19
A31	AD18	A32	AD16	B31	+3.3V	B32	AD17
A33	+3.3V	A34	-FRAME	B33	-CBE2	B34	GND
A35	GND	A36	-TRDY	B35	-IRDY	B36	+3.3V
A37	GND	A38	-STOP	B37	-DEVSEL	B38	GND
A39	+3.3V	A40	GND	B39	-PLOCK	B40	-PERR
A41	NC	A42	GND	B41	+3.3V	B42	-SERR
A43	PAR	A44	AD15	B43	+3.3V	B44	-CBE1
A45	+3.3V	A46	AD13	B45	AD14	B46	GND
A47	AD11	A48	GND	B47	AD12	B48	AD10
A49	AD9	A50	-	B49	GND	B50	-
A51	-	A52	-CBE0	B51	-	B52	AD8
A53	+3.3V	A54	AD6	B53	AD7	B54	+3.3V
A55	AD4	A56	GND	B55	AD5	B56	AD3
A57	AD2	A58	AD0	B57	GND	B58	AD1
A59	+5V	A60	-P1REQ64	B59	+5V	B60	-P1ACK64
A61	+5V	A62	+5V	B61	+5V	B62	+5V

Table 20: PCI slot 2 pinouts

A.3.3.4. IDE1 and IDE2: IDE Connectors

(2nd optional)

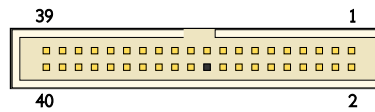

Figure 42: IDE connector diagram

IDE1				IDE2			
Pin	Signal	Pin	Signal	Pin	Signal	Pin	Signal
1	IDERST_D1	2	GND	1	IDERST_D2	2	GND
3	DD7A_D1	4	DD8A_D1	3	DD7A_D2	4	DD8A_D2
5	DD6A_D1	6	DD9A_D1	5	DD6A_D2	6	DD9A_D2
7	DD5A_D1	8	DD10A_D1	7	DD5A_D2	8	DD10A_D2
9	DD4A_D1	10	DD11A_D1	9	DD4A_D2	10	DD11A_D2
11	DD3A_D1	12	DD12A_D1	11	DD3A_D2	12	DD12A_D2
13	DD2A_D1	14	DD13A_D1	13	DD2A_D2	14	DD13A_D2
15	DD1A_D1	16	DD14A_D1	15	DD1A_D2	16	DD14A_D2
17	DD0A_D1	18	DD15A_D1	17	DD0A_D2	18	DD15A_D2
19	GND	20	Key	19	GND	20	Key
21	DMARQA_D1	22	GND	21	DMARQA_D2	22	GND
23	DIOWnA_D1	24	GND	23	DIOWnA_D2	24	GND
25	DIORnA_D1	26	GND	25	DIORnA_D2	26	GND
27	IORDYA_D1	28	CSELA_D1	27	IORDYA_D2	28	CSELA_D2
29	DMACKnA_D1	30	GND	29	DMACKnA_D2	30	GND
31	INTRQA_D1	32	NC	31	INTRQA_D2	32	NC
33	DA1A_D1	34	CBLID_P	33	DA1A_D2	34	PDIAG_S
35	DA0A_D1	36	DA2A_D1	35	DA0A_D2	36	DA2A_D2
37	CS0nA_D1	38	CS1nA_D1	37	CS0nA_D2	38	CS1nA_D2
39	DASPNXA1_D1	40	GND	39	DASPNXA1_D2	40	GND

Table 21: IDE connector pinouts

A.3.3.5. LVDS1: LVDS Panel Connector

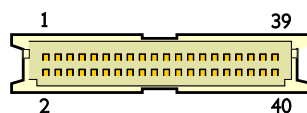

Figure 43: LVDS panel connector diagram

Pin	Signal	Pin	Signal
1	D4-	2	PVDD1
3	D4+	4	PVDD1
5	GND	6	GND
7	D5-	8	GND
9	D5+	10	D0-
11	GND	12	D0+
13	D6-	14	GND
15	D6+	16	D1-
17	GND	18	D1+
19	CLK2-	20	GND
21	CLK2+	22	D2-
23	GND	24	D2+
25	D7-	26	GND
27	D7+	28	CLK1-
29	NC	30	CLK1+
31	GND	32	GND
33	+3.3V / PVDD (optional)	34	D3-
35	NC	36	D3+
37	NC	38	LCD_CLK
39	NC	40	LCD_DATA

Table 22: LVDS panel connector pinouts

A.3.3.6. BL1: Backlight Connector

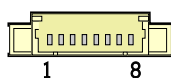

Figure 44: Backlight connector diagram

Pin	Signal	Pin	Signal
1	VDD_BL	5	ENABLT1
2	VDD_BL	6	BL_CTL
3	ENABLT1	7	GND
4	NC	8	GND

Table 23: Backlight connector pinouts

A.3.3.7. CNX1~ CNX4: ETX Connector X1, X2, X3 and X4



Figure 45: ETX connector X1, X2, X3 and X4 diagram

CNX1							
Pin	Signal	Pin	Signal	Pin	Signal	Pin	Signal
1	GND	2	GND	51	+5V	52	+5V
3	PCICLK3	4	PCICLK4	53	PAR	54	-SERR
5	GND	6	GND	55	-PERR	56	NC
7	PCICLK1	8	PCICLK2	57	-PME	58	USB2-
9	-REQ3	10	-GNT3	59	-PLOCK	60	-DEVSEL
11	GNT2	12	+3.3VMAIN	61	-TRDY	62	USB3-
13	REQ2	14	-GNT1	63	-IRDY	64	-STOP
15	REQ1	16	+3.3VMAIN	65	-FRAME	66	USB2+
17	-GNT0	18	NC	67	GND	68	GND
19	+5V	20	+5V	69	AD16	70	-CBE2
21	SERIRQ1	22	-REQ0	71	AD17	72	USB3+
23	AD0	24	+3.3VMAIN	73	AD19	74	AD18
25	AD1	26	AD2	75	AD20	76	USB0-
27	AD4	28	AD3	77	AD22	78	AD21
29	AD6	30	AD5	79	AD23	80	USB1-
31	-CBE0	32	AD7	81	AD24	82	-CBE3
33	AD8	34	AD9	83	+5V	84	+5V
35	GND	36	GND	85	AD25	86	AD26
37	AD10	38	AUXAL	87	AD28	88	USB0+
39	AD11	40	MIC	89	AD27	90	AD29
41	AD12	42	AUXAR	91	AD30	92	USB1+
43	AD13	44	ASVCC	93	-PCIRST	94	AD31
45	AD14	46	SNDL	95	-INTC	96	-INTD
47	AD15	48	ASGND	97	-INTA	98	-INTB
49	-CBE1	50	SNDR	99	GND	100	GND

Table 24: ETX connector X1 pinouts

CNX2							
Pin	Signal	Pin	Signal	Pin	Signal	Pin	Signal
1	GND	2	GND	51	+5V	52	+5V
3	SD14	4	SD15	53	SA6	54	IRQ5
5	SD13	6	-MASTER	55	SA7	56	IRQ6
7	SD12	8	DREQ7	57	SA8	58	IRQ7
9	SD11	10	-DACK7	59	SA9	60	SYS_CLK
11	SD10	12	DREQ6	61	SA10	62	-REFRESH
13	SD9	14	-DACK6	63	SA11	64	DREQ1
15	SD8	16	DREQ5	65	SA12	66	-DACK1
17	-MEMW	18	-DACK5	67	GND	68	GND
19	-MEMR	20	DREQ0	69	SA13	70	DREQ3
21	LA17	22	-DACK0	71	SA14	72	-DACK3
23	LA18	24	ISA_IRQ14	73	SA15	74	-IOR
25	LA19	26	ISA_IRQ15	75	SA16	76	-IOW
27	LA20	28	IRQ12	77	SA18	78	SA17
29	LA21	30	IRQ11	79	SA19	80	-SMEMR
31	LA22	32	IRQ10	81	-IOCHRDY	82	AEN
33	LA23	34	-IOCS16	83	+5V	84	+5V
35	GND	36	GND	85	SD0	86	-SMEMW
37	-SBHE	38	-MEMCS16	87	SD2	88	SD1
39	SA0	40	ISA_OSC	89	SD3	90	-OWS
41	SA1	42	BALE	91	DREQ2	92	SD4
43	SA2	44	TC	93	SD5	94	IRQ9
45	SA3	46	-DACK2	95	SD6	96	SD7
47	SA4	48	IRQ3	97	-IOCHCK	98	-RSTDRV
49	SA5	50	IRQ4	99	GND	100	GND

Table 25: ETX connector X2 pinouts

CNX3									
Pin	Signal	Pin	Signal	Pin	Signal	Pin	Signal	Pin	Signal
1	GND	2	GND	51	NC	52	NC		
3	REDN	4	BLUEN	53	+5V	54	GND		
5	HS	6	GREENN	55	P_-STB	56	P_-AFD		
7	VS	8	DDCCLKN	57	NC	58	P_PRD7		
9	NC	10	DDCDATAN	59	IRRX	60	P_-ERR		
11	LVDSCLK2-	12	LVDS7-	61	IRTX	62	P_PRD6		
13	LVDSCLK2+	14	LVDS7+	63	SIN2	64	P_-INIT		
15	GND	16	GND	65	GND	66	GND		
17	LVDS5+	18	LVDS6+	67	RTS2	68	P_PRD5		
19	LVDS5-	20	LVDS6-	69	DTR2	70	P_-SLIN		
21	GND	22	GND	71	DCD2	72	P_PRD4		
23	LVDS3-	24	LVDS4+	73	DSR2	74	P_PRD3		
25	LVDS3+	26	LVDS4-	75	CTS2	76	P_PRD2		
27	GND	28	GND	77	SOUT2	78	P_PRD1		
29	LVDS2-	30	LVDSCLK1+	79	RI2	80	P_PRD0		
31	LVDS2+	32	LVDSCLK1-	81	+5V	82	+5V		
33	GND	34	GND	83	SIN1	84	P_-ACK		
35	LVDS0+	36	LVDS1+	85	RTS1	86	P_BUSY		
37	LVDS0-	38	LVDS1-	87	DTR1	88	P_PE		
39	+5V	40	+5V	89	DCD1	90	P_SLCT		
41	JILI_DAT	42	NC	91	DSR1	92	MSCK		
43	JILI_CLK	44	BLON	93	CTS1	94	MSDT		
45	BIASON	46	DIGON	95	SOUT1	96	KBCK		
47	NC	48	NC	97	RI1	98	KBBDT		
49	NC	50	NC	99	GND	100	GND		

Table 26: ETX connector X3 pinouts

CNX4									
Pin	Signal	Pin	Signal	Pin	Signal	Pin	Signal	Pin	Signal
1	GND	2	GND	51	-SDIOW	52	-PDIOR		
3	+5VSUS	4	ATX_PG	53	SDDREQ	54	-PDIOW		
5	PS_ON-	6	SPEAKER	55	SDD15	56	PDDREQ		
7	PW_BN-	8	+3.3VBAT	57	SDD0	58	PDD15		
9	NC	10	LILED-	59	SDD14	60	PDD0		
11	RSMRST-	12	ACTLED-	61	SDD1	62	PDD14		
13	NC	14	SPEEDLED-	63	SDD13	64	PDD1		
15	NC	16	I ² C_CLK	65	GND	66	GND		
17	+5V	18	+5V	67	SDD2	68	PDD13		
19	OVCR-	20	NC	69	SDD12	70	PDD2		
21	EXTSMI-	22	I ² C_DAT	71	SDD3	72	PDD12		
23	SMB_CLK	24	SMBDATA	73	SDD11	74	PDD3		
25	-SDCS3	26	-SMBALRT	75	SDD4	76	PDD11		
27	-SDCS1	28	-HD_LED	77	SDD10	78	PDD4		
29	SDA2	30	-PDCS3	79	SDD5	80	PDD10		
31	SDA0	32	-PDCS1	81	+5V	82	+5V		
33	GND	34	GND	83	SDD9	84	PDD5		
35	PDIAG_S	36	PDA2	85	SDD6	86	PDD9		
37	SDA1	38	PDA0	87	SDD8	88	PDD6		
39	IRQ15	40	PDA1	89	-RING	90	CBLID_P		
41	NC	42	GPE1-	91	RXD-	92	PDD8		
43	-SDDACK	44	IRQ14	93	RXD+	94	SDD7		
45	SIORDY	46	-PDDACK	95	TXD-	96	PDD7		
47	-SDIOR	48	PIORDY	97	TXD+	98	-IEDRST1		
49	+5V	50	+5V	99	GND	100	GND		

Table 27: ETX connector X4 pinouts

A.3.4. Pin Headers and Jumpers Pin Definition

A.3.4.1. F_AUDIO1 and I2C1: Front Audio and I²C Pin Headers

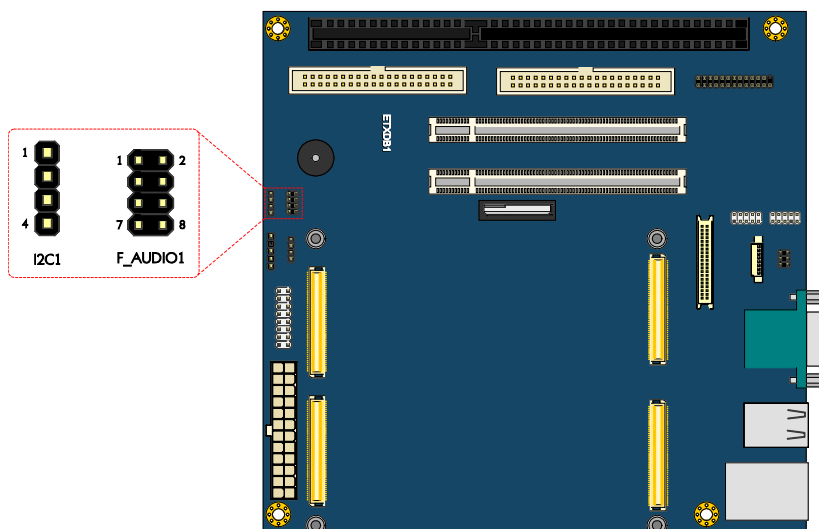

Figure 46: Front audio and I²C pin headers diagram

Pin	Signal	Pin	Signal
1	AUXAR	2	AGND
3	AUXAL	4	MICIN
5	SNDR	6	NC
7	SNDL	8	AGND

Table 28: Front audio pin header pinouts

Pin	Signal
1	+5V / +3V (optional)
2	CLK
3	DAT
4	GND

Table 29: I²C pin header pinouts

A.3.4.2. SIR1 and SMB1: Serial Infrared and SMBus Pin Headers

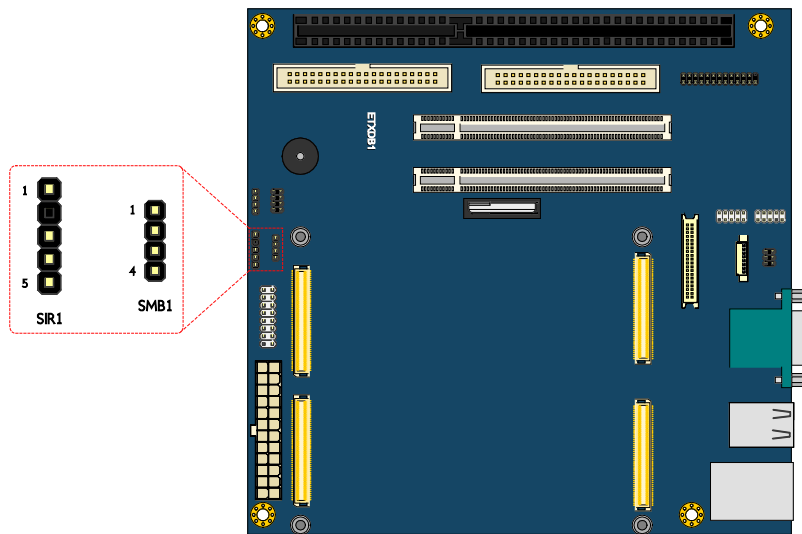

Figure 47: Serial Infrared and SMBus pin headers diagram

Pin	Signal
1	+5V
2	Key
3	IRRX
4	GND
5	IRTX

Table 30: Serial Infrared pin header pinouts

Pin	Signal
1	+3.3V
2	CLK
3	DAT
4	GND

Table 31: SMBus pin header pinouts

A.3.4.3. F_PANEL1 and LPT1: Front Panel and LPT Pin Headers

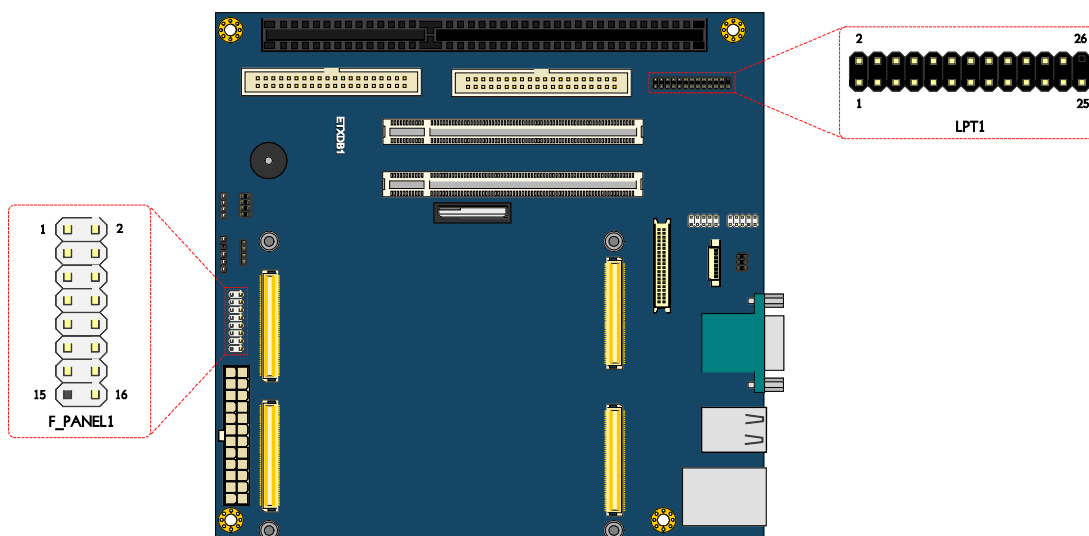

Figure 48: Front panel and LPT pin headers diagram

Pin	Signal	Pin	Signal
1	Power LED+	2	+5V
3	Power LED+	4	HDD_LED-
5	Power LED-	6	Power button
7	+5V	8	GND
9	NC	10	Reset
11	NC	12	GND
13	Speaker-	14	+5V
15	Key	16	NC

Table 32: Front panel pin header pinouts

Pin	Signal	Pin	Signal
1	-STB	2	-AFD
3	D0	4	-ERR
5	D1	6	-INIT
7	D2	8	-SLIN
9	D3	10	GND
11	D4	12	GND
13	D5	14	GND
15	D6	16	GND
17	D7	18	GND
19	-ACK	20	GND
21	BUSY	22	GND
23	PE	24	GND
25	SCLT	26	Key

Table 33: LPT pin header pinouts

A.3.4.4. COM2 and KBMS1: COM and Keyboard & Mouse Pin Headers

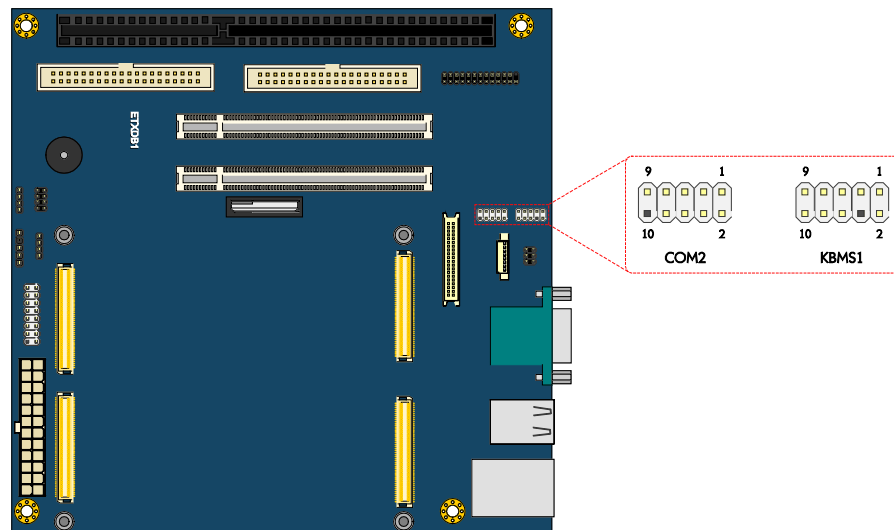

Figure 49: COM and Keyboard & mouse pin headers diagram

Pin	Signal	Pin	Signal
1	DCD2-	2	RXD2-
3	TXD2-	4	DTR2-
5	GND	6	DSR2-
7	RTS2	8	CTS2-
9	RI2-	10	Key

Table 34: COM pin header pinouts

Pin	Signal	Pin	Signal
1	+5VSUS	2	+5VSUS
3	NC	4	Key
5	GND	6	GND
7	KB_DT	8	MS_DT
9	KB_CK	10	MS_CK

Table 35: Keyboard & mouse pin header pinouts

A.3.4.5. J1: Backlight and Panel Power Jumper

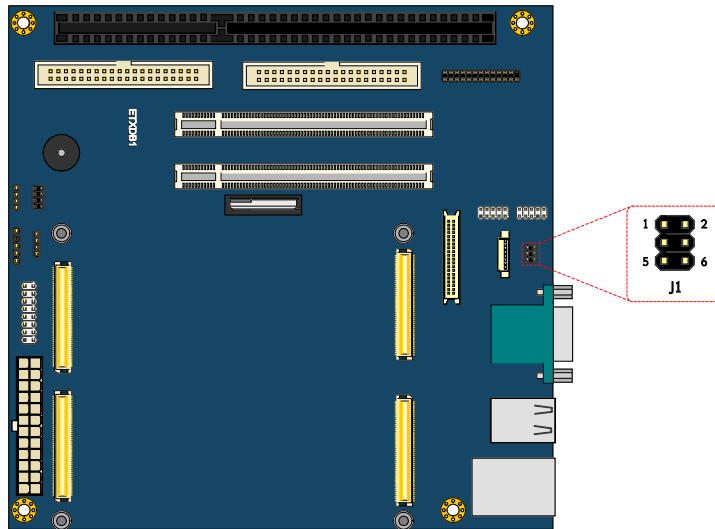

Figure 50: Backlight and Panel power jumper diagram

Backlight voltage setting	Pin 1	Pin 3	Pin 5
+12V	Short	Short	Open
+5V	Open	Short	Short
Panel voltage setting	Pin 2	Pin 4	Pin 6
+3.3V	Short	Short	Open
+5V	Open	Short	Short

Table 36: Backlight and Panel power jumper settings

A.4. ETXDB1 Dimensions

A.4.1. ETXDB1 Board Dimensions

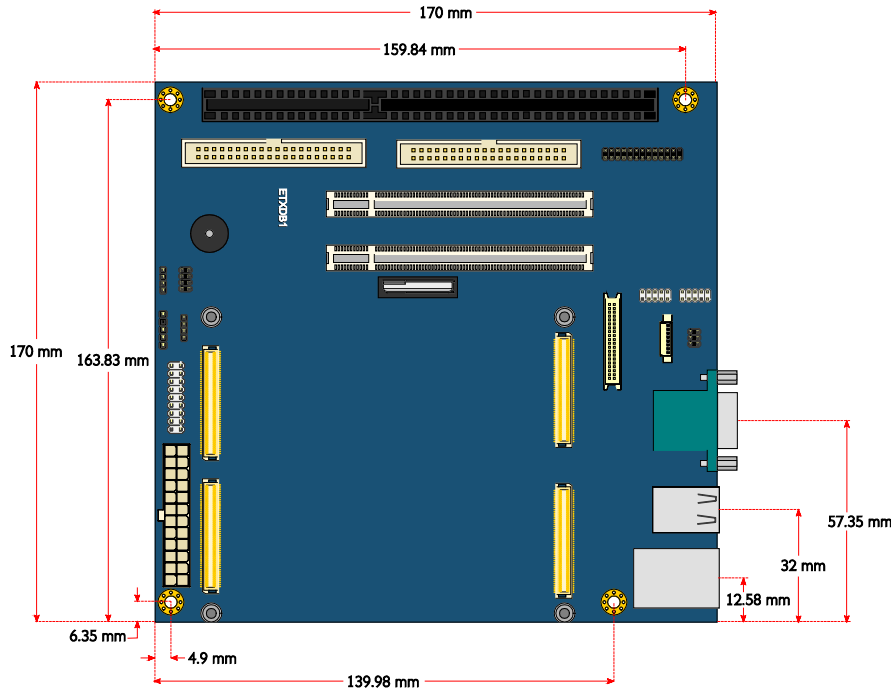

Figure 51: ETXDB1 board dimensions diagram

A.4.2. ETXDB1 External I/O Dimensions

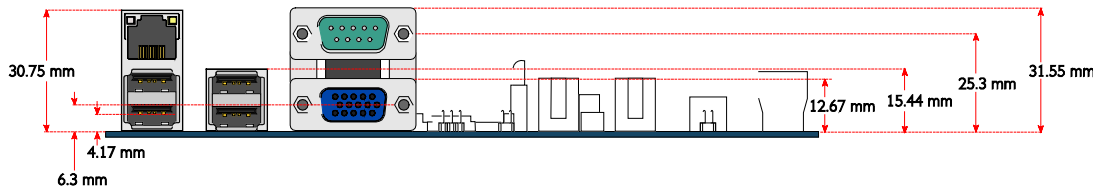

Figure 52: ETXDB1 External I/O dimensions diagram



Taiwan Headquarters

1F, 531 Zhong-zheng Road,
Xindian Dist., New Taipei City 231
Taiwan

Tel: 886-2-2218-5452
Fax: 886-2-2218-9860
Email: embedded@via.com.tw



USA

940 Mission Court
Fremont, CA 94539,
USA

Tel: 1-510-687-4688
Fax: 1-510-687-4654
Email: embedded@viatech.com



Japan

3-15-7 Ebisu MT Bldg. 6F,
Higashi, Shibuya-ku
Tokyo 150-0011
Japan

Tel: 81-3-5466-1637
Fax: 81-3-5466-1638
Email: embedded@viatech.co.jp



China

Tsinghua Science Park Bldg. 7
No. 1 Zongguancun East Road,
Haidian Dist., Beijing, 100084
China

Tel: 86-10-59852288
Fax: 86-10-59852299
Email: embedded@viatech.com.cn



Europe

Email: embedded@via-tech.eu