



USER MANUAL

VIA VB7009

Flexible Mini-ITX board with
advanced multimedia, I/O,
and connectivity features



Copyright

Copyright © 2016-2020 VIA Technologies Incorporated. All rights reserved.

No part of this document may be reproduced, transmitted, transcribed, stored in a retrieval system, or translated into any language, in any form or by any means, electronic, mechanical, magnetic, optical, chemical, manual or otherwise without the prior written permission of VIA Technologies, Incorporated.

Trademarks

All trademarks are the property of their respective holders.

Disclaimer

No license is granted, implied or otherwise, under any patent or patent rights of VIA Technologies. VIA Technologies makes no warranties, implied or otherwise, in regard to this document and to the products described in this document. The information provided in this document is believed to be accurate and reliable as of the publication date of this document. However, VIA Technologies assumes no responsibility for the use or misuse of the information (including use or connection of extra device/equipment/add-on card) in this document and for any patent infringements that may arise from the use of this document. The information and product specifications within this document are subject to change at any time, without notice and without obligation to notify any person of such change.

VIA Technologies, Inc. reserves the right the make changes to the products described in this manual at any time without prior notice.

Regulatory Compliance

FCC-A Radio Frequency Interference Statement

This equipment has been tested and found to comply with the limits for a class A digital device, pursuant to part 15 of the FCC rules. These limits are designed to provide reasonable protection against harmful interference when the equipment is operated in a commercial environment. This equipment generates, uses, and can radiate radio frequency energy and, if not installed and used in accordance with the instruction manual, may cause harmful interference to radio communications. Operation of this equipment in a residential area is likely to cause harmful interference, in which case the user will be required to correct the interference at his personal expense.

Notice 1

The changes or modifications not expressly approved by the party responsible for compliance could void the user's authority to operate the equipment.

Notice 2

Shielded interface cables and A.C. power cord, if any, must be used in order to comply with the emission limits.

Notice 3

The product described in this document is designed for general use, VIA Technologies assumes no responsibility for the conflicts or damages arising from incompatibility of the product. Check compatibility issue with your local sales representatives before placing an order.



**Tested To Comply
With FCC Standards
FOR HOME OR OFFICE USE**

Battery Recycling and Disposal

- Only use the appropriate battery specified for this product.
- Do not re-use, recharge, or reheat an old battery.
- Do not attempt to force open the battery.
- Do not discard used batteries with regular trash.
- Discard used batteries according to local regulations.



Safety Precautions

- Always read the safety instructions carefully.
- Keep this User's Manual for future reference.
- All cautions and warnings on the equipment should be noted.
- Keep this equipment away from humidity.
- Put this equipment on a reliable flat surface before setting it up.
- Check the voltage of the power source and adjust properly 110/220V before connecting the equipment to the power inlet.
- Do not place the power cord where people will step on it.
- Always unplug the power cord before inserting any add-on card or module.
- If any of the following situations arise, get the equipment checked by authorized service personnel:
 - The power cord or plug is damaged.
 - Liquid has entered into the equipment.
 - The equipment has been exposed to moisture.
 - The equipment is faulty or you cannot get it work according to User's Manual.
 - The equipment has been dropped and damaged.
 - The equipment has an obvious sign of breakage.
- Do not leave this equipment in extreme temperatures or in a storage temperature above 60°C (140°F). The equipment may be damaged.
- Do not leave this equipment in direct sunlight.
- Never pour any liquid into the opening. Liquid can cause damage or electrical shock.
- Do not place anything over the power cord.
- Do not cover the ventilation holes. The openings on the enclosure protect the equipment from overheating.

Box Contents

- 1 x VIA VB7009 board
- 1 x SATA cable
- 1 x I/O bracket

Ordering Information

Part Number	Description
VB7009-12QCE	Mini-ITX Board with 1.2GHz VIA Eden® X4 CPU with VGA, LVDS, 8 x USB 2.0, 6 x COM, 2 x Gigabit Ethernet, 2 x SATA, PCI slot, ATX connector
VB7009-16	Mini-ITX Board with 1.6GHz VIA C7®-D CPU with VGA, LVDS, 8 x USB 2.0, 4 x COM, 2 x Gigabit Ethernet, 2 x SATA, PCI slot, ATX connector
VB7009-10E	Mini-ITX Board with 1.0GHz VIA C7® CPU with VGA, LVDS, 8 x USB 2.0, 4 x COM, 2 x Gigabit Ethernet, 2 x SATA, PCI slot, ATX connector

Optional Accessories

I/O Expansion Cards

Part Number	Description
LPC-01	Expansion module for four COM ports
LPC-02	Expansion module for four COM ports (5V or 12V)
LPC-04	Expansion module for two or four COM ports (5V or 12V)
EXT-PCI	One to two PCI riser card

Wireless Modules

Part Number	Description
EMIO-1533-00A2	VNT9271 IEEE 802.11b/g/n USB Wi-Fi module with assembly kit and antenna
EMIO-5531-00A1	VAB-820-W IEEE 802.11b/g/n USB Wi-Fi & Bluetooth module with assembly kit and antenna

Table of Contents

1. Product Overview	1
1.1. Key Features and Benefits	1
1.1.1. VIA C7 [®] -D / C7 [®] / Eden [®] X4 Processor	1
1.1.2. VIA VX900 MSP	1
1.1.3. Modular Expansion Options	1
1.2. Product Specifications	2
1.3. Layout Diagram	4
1.4. Product Dimensions	5
1.5. Height Distribution	6
2. I/O Interface	7
2.1. External I/O Ports	7
2.1.1. PS/2 Ports	7
2.1.2. VGA Port	8
2.1.3. COM Port	8
2.1.4. Parallel Port	9
2.1.5. Gigabit Ethernet Port	10
2.1.6. USB 2.0 Ports	11
2.1.7. Audio Jacks	11
2.2. Onboard IO	12
2.2.1. ATX Power Connector	12
2.2.2. CMOS Battery Slot	13
2.2.3. Front Panel Pin Header	14
2.2.4. Front Audio Pin Header	15
2.2.5. SMBus Pin Header	16
2.2.6. CPU and System Fan Connectors	17
2.2.7. SATA Connectors	18
2.2.8. USB 2.0 Pin Headers	19
2.2.9. COM Pin Headers	20
2.2.10. PS/2 Keyboard and Mouse Pin Header	21
2.2.11. LVDS Panel Connector	22
2.2.12. LVDS Inverter Connector	24
2.2.13. S/PDIF Connector	25
2.2.14. SPI Pin Header	26
2.2.15. LPC Pin Header	27
2.2.16. Digital I/O Pin Header	28
2.2.17. Temperature Sensor Pin Header	29
3. Jumpers	30
3.1. Clear CMOS Jumper	31
3.2. COM Voltage Jumpers	32
3.2.1. COM2 Voltage Jumper	32
3.2.2. COM3 and COM4 Voltage Jumper	33
3.2.3. COM5 and COM6 Voltage Jumper	34
3.3. SATA DOM Power Jumper	35
3.4. LVDS Panel Power Jumper	36
3.5. LVDS Inverter Power Jumper	37
4. Expansion Slots	38
4.1. DDR3 Memory Slots	38
4.1.1. Installing a Memory Module	39
4.1.2. Removing a Memory Module	40
4.2. PCI Slot	41
5. Installing into a Chassis	42
5.1.1. Suggested Minimum Chassis Dimensions	42
5.1.2. Suggested Minimum Chassis Height	43



5.1.3.	Suggested Keepout Areas	43
6.	BIOS Setup Utility.....	44
6.1.	Entering the BIOS Setup Utility	44
6.2.	Control Keys	44
6.3.	Navigating the BIOS Menus.....	44
6.4.	Getting Help.....	44
6.5.	Main Menu (BIOS for VB7009-16 / VB7009-10E SKU).....	45
6.5.1.	Standard CMOS Features	45
6.5.2.	Advanced BIOS Features	45
6.5.3.	Advanced Chipset Features	45
6.5.4.	Integrated Peripherals	45
6.5.5.	Power Management Setup	45
6.5.6.	PnP/PCI Configurations.....	45
6.5.7.	PC Health Status.....	45
6.5.8.	Frequency/Voltage Control	45
6.5.9.	Load Optimized Defaults	46
6.5.10.	Set Supervisor Password.....	46
6.5.11.	Set User Password.....	46
6.5.12.	Save & Exit Setup	46
6.5.13.	Exit Without Saving.....	46
6.6.	Standard CMOS Features.....	47
6.6.1.	Date	47
6.6.2.	Time.....	47
6.6.3.	Video.....	47
6.6.4.	Halt On.....	47
6.7.	IDE Channels	48
6.8.	Advanced BIOS Features	50
6.8.1.	Quick Power On Self-Test	50
6.8.2.	First/Second/Third Boot Device	50
6.8.3.	Boot Other Device.....	50
6.8.4.	Boot Up NumLock Status	51
6.8.5.	Security Option.....	51
6.8.6.	Full Screen Logo Show	51
6.8.7.	Summary Screen Show	51
6.9.	CPU Feature	52
6.9.1.	Thermal Management.....	52
6.9.2.	PMON support.....	52
6.10.	Hard Disk Boot Priority.....	53
6.11.	Advanced Chipset Features.....	54
6.11.1.	LCD Clock Source Control	54
6.11.2.	LCD Backlight Control	54
6.12.	PCIe Bus Control.....	55
6.12.1.	PCIe Root Port.....	55
6.12.2.	PCIe Target Link Speed	55
6.12.3.	PCIe PE0 Control	55
6.12.4.	PCIe Hot-Reset Enable.....	55
6.12.5.	PCIe Root-Port-Reset Enable	55
6.12.6.	Maximum Payload Size	55
6.12.7.	PCIe ASPM Function	55
6.13.	UMA & P2P Bridge Control.....	56
6.13.1.	UMA Enable	56
6.13.2.	VGA Share Memory Size	56
6.13.3.	CPU Direct Access FB.....	56
6.13.4.	Select Display Device	56
6.13.5.	Select Display Device 1.....	56
6.13.6.	Select Display Device 2.....	56
6.13.7.	Panel Type	56
6.13.8.	Engine Clock Control.....	56



6.14. CPU & PCI Bus Control.....	57
6.14.1. PCI Master 0 WS Write.....	57
6.14.2. PCI Delay Transaction.....	57
6.14.3. SB P2P Bridge.....	57
6.15. Integrated Peripherals.....	58
6.16. VIA OnChip IDE Device.....	58
6.16.1. OnChip SATA.....	58
6.17. VIA OnChip PCI Device.....	59
6.17.1. Onboard PCIE LAN.....	59
6.17.2. Hide D1F1.....	59
6.17.3. OnChip HDAC Device.....	59
6.17.4. Clear HDA Wake Enable bit.....	59
6.17.5. NB HD Audio Codec 1.....	59
6.18. SuperIO Device.....	60
6.18.1. Onboard Serial Ports 1 ~ 4.....	60
6.18.2. Onboard Parallel Port.....	60
6.18.3. Parallel Port Mode.....	60
6.18.4. ECP Mode Use DMA.....	60
6.19. USB Device Setting.....	61
6.19.1. USB 1.0 Controller.....	61
6.19.2. USB 2.0 Controller.....	61
6.19.3. USB Operation Mode.....	61
6.19.4. USB Keyboard Function.....	61
6.19.5. USB Mouse Function.....	61
6.19.6. USB Storage Function.....	61
6.20. Power Management Setup.....	62
6.20.1. EuP/ErP Lot6.....	62
6.20.2. ACPI Suspend Type.....	62
6.20.3. Soft-Off by PWRBTN.....	62
6.20.4. Run VGABIOS if S3 Resume.....	62
6.20.5. AC Loss Auto Restart.....	63
6.20.6. HPET Support.....	63
6.20.7. WDRT Support.....	63
6.20.8. WDRT Run/Stop.....	63
6.20.9. WDRT Count.....	63
6.21. Wakeup Event Detect.....	64
6.21.1. PS2KB Wakeup Select.....	64
6.21.2. PS2KB Wakeup Key Select.....	64
6.21.3. PS2MS Wakeup Key Select.....	64
6.21.4. PS2 Keyboard Power ON.....	64
6.21.5. PS2 Mouse Power ON.....	64
6.21.6. RTC Alarm Resume.....	64
6.21.7. Date (of Month).....	65
6.21.8. Resume Time (hh:mm:ss).....	65
6.22. PnP/PCI Configurations.....	66
6.22.1. Init Display First.....	66
6.22.2. Resources Controlled By.....	66
6.23. PC Health Status.....	67
6.24. Frequency/Voltage Control.....	68
6.24.1. DRAM Clock.....	68
6.24.2. Spread Spectrum.....	68
6.25. Load Optimized Defaults.....	69
6.26. Set Supervisor/User Password.....	70
6.27. Save & Exit Setup.....	71
6.28. Exit Without Saving.....	71
6.29. Main Menu (BIOS for VB7009-12QCE SKU).....	72
6.29.1. AMIBIOS.....	72
6.29.2. Processor.....	72
6.29.3. System Memory.....	72



6.29.4. System Time	72
6.29.5. System Date	72
6.30. Advanced Settings	73
6.30.1. CPU Configuration	74
6.30.2. IDE Configuration	74
6.30.3. SuperIO Configuration	75
6.30.3.1. Serial Ports 1 to 6 Address	75
6.30.3.2. Parallel Port	75
6.30.3.2.1. Parallel Port Mode	75
6.30.4. Hardware Health Configuration	76
6.30.4.1. CPU FAN Mode Setting	76
6.30.4.2. System FAN Mode Setting	76
6.30.5. ACPI Settings	77
6.30.5.1. Suspend Mode	77
6.30.5.2. ACPI Version Features	77
6.30.5.3. USB S4 Wakeup	77
6.30.6. APM Settings	78
6.30.6.1. Power Button Mode	78
6.30.6.2. Restore on AC/Power Loss	78
6.30.6.3. Resume on PS/2 KBC	79
6.30.6.4. Wake-Up Key	79
6.30.6.5. Wake-Up Password	79
6.30.6.6. Resume on PS/2 Mouse	79
6.30.6.7. PCI LAN S5 Wakeup	79
6.30.6.8. Resume on RTC Alarm	79
6.30.6.9. RTC Alarm Date (Days)	80
6.30.6.10. System Time	80
6.30.7. Spread Spectrum Configuration	80
6.30.7.1. Spread Spectrum Setting	80
6.30.8. USB Configuration	81
6.30.8.1. Legacy USB Support	81
6.30.8.2. USB2.0 Controller Mode	81
6.30.9. CRB Configuration	82
6.30.9.1. VT6130 LAN Control	82
6.30.9.2. LAN Option ROM	82
6.31. Boot Settings	83
6.31.1. Boot Settings Configuration	83
6.31.1.1. Quick Boot	84
6.31.1.2. Quiet Boot	84
6.31.1.3. Bootup Num-Lock	84
6.31.1.4. Wait for 'F1' if Error	84
6.31.1.5. Hit 'DEL' Message Display	84
6.32. Security Settings	85
6.32.1. Security Settings	85
6.32.1.1. Change Supervisor Password	85
6.32.1.2. Password Check	85
6.33. Advanced Chipset Settings	86
6.33.1. North Bridge VIA VX900 Configuration	86
6.33.1.1. DRAM Clock/Timing Configuration	87
6.33.1.1.1. DRAM Clock	87
6.33.1.2. OnChip VGA Configuration	88
6.33.1.2.1. Select Display Device 1 and 2	88
6.33.1.2.2. Panel Type	88
6.33.1.2.3. VGA Share Memory (Frame Buffer)	88
6.33.1.2.4. CPU Direct Access Frame Buffer	88
6.33.1.2.5. LCD Clock Source Control	89
6.33.1.2.6. LCD Backlight Control	89
6.33.2. South Bridge VIA VX900 Configuration	89
6.33.2.1. OnChip HDAC Device	89



6.33.2.2. WATCHDOG Timer Enable.....	89
6.33.2.3. Eup/ErP Lot6 support.....	89
6.34. Exit Options.....	90
6.34.1. Save Changes and Exit.....	90
6.34.2. Discard Changes and Exit.....	90
6.34.3. Discard Changes.....	90
6.34.4. Load Optimal Defaults.....	90
7. Software and Technical Support.....	91
7.1 Microsoft and Linux Support.....	91
7.1.1. Driver Installation.....	91
7.2 Technical Support and Assistance.....	91
Appendix A. Installing Wireless Accessories.....	92
A.1. Installing the VIA EMIO-1533 USB Wi-Fi Module.....	92
A.2. Installing the VIA EMIO-5531 USB Wi-Fi & Bluetooth Module.....	94
Appendix B. Power Consumption Report.....	96
B.1. VB7009-16.....	96
B.1.1. System Idle – Windows 7 32-bit.....	96
B.1.2. S3 Status – Windows 7 Sleep.....	96
B.1.3. MP3 Playback – Windows Media Player10.....	96
B.1.4. DVD Playback – PowerDVD 8.0.....	96
B.1.5. Graphics – Run 3DMarks'06.....	97
B.1.6. Functional Test – Run Passmark BurnIn test 6.0.....	97
B.1.7. Network Access <Single LAN> – Gigabit Ethernet File Transmitting.....	97
B.1.8. Network Access <Dual LAN> – Gigabit Ethernet File Transmitting.....	97
B.2. VB7009-10E.....	98
B.2.1. System Idle – Windows 7 32-bit.....	98
B.2.2. S3 Status – Windows 7 Sleep.....	98
B.2.3. MP3 Playback – Windows Media Player10.....	98
B.2.4. DVD Playback – PowerDVD 8.0.....	98
B.2.5. Graphics – Run 3DMarks'06.....	99
B.2.6. Functional Test – Run Passmark BurnIn test 6.0.....	99
B.2.7. Network Access <Single LAN> – Gigabit Ethernet File Transmitting.....	99
B.2.8. Network Access <Dual LAN> – Gigabit Ethernet File Transmitting.....	99
B.3. VB7009-12QCE.....	100
B.3.1. System Idle – Windows 7 64bit.....	100
B.3.2. S3 Status – Windows 7 Sleep (EuP Disable).....	100
B.3.3. MP3 Playback – Windows Media Player10.....	101
B.3.4. MP4 Playback –KM Player10.....	101
B.3.5. Graphics – Run 3DMarks'06.....	101
B.3.6. Functional Test – Run Passmark BurnIn test 6.0.....	102
B.3.7. Network Access <Dual LAN> – Gigabit Ethernet File Transmitting.....	102
B.3.8. S5 Status – Windows 7 Shut down (EuP Disable).....	102
B.3.9. S5 Status – Windows 7 Shut down (EuP Enable).....	103
Appendix C. Mating Connector Vendors List.....	104

Lists of Figures

Figure 1: Layout diagram of the VIA VB7009 board (top side)	4
Figure 2: Mounting holes and dimensions of the VIA VB7009	5
Figure 3: External I/O port dimensions of the VIA VB7009	5
Figure 4: Height distribution of the VIA VB7009 (for fan model)	6
Figure 5: Back panel I/O ports	7
Figure 6: PS/2 ports diagram	7
Figure 7: VGA port diagram	8
Figure 8: COM port diagram	8
Figure 9: Parallel port diagram	9
Figure 10: Gigabit Ethernet port diagram	10
Figure 11: USB 2.0 port diagram	11
Figure 12: Audio jack receptacle stack diagram	11
Figure 13: ATX power connector diagram	12
Figure 14: CMOS battery slot diagram	13
Figure 15: Front panel pin header diagram	14
Figure 16: Front audio pin header diagram	15
Figure 17: SMBus pin header diagram	16
Figure 18: CPU and System fan connectors diagram	17
Figure 19: SATA connectors diagram	18
Figure 20: USB 2.0 pin header diagram	19
Figure 21: COM pin headers diagram	20
Figure 22: PS/2 keyboard and mouse pin header diagram	21
Figure 23: LVDS panel connector diagram	22
Figure 24: LVDS inverter connector diagram	24
Figure 25: S/PDIF connector diagram	25
Figure 26: SPI pin header diagram	26
Figure 27: LPC pin header diagram	27
Figure 28: Digital I/O pin header diagram	28
Figure 29: Temperature sensor pin header diagram	29
Figure 30: Jumper settings example	30
Figure 31: Clear CMOS jumper diagram	31
Figure 32: COM2 voltage jumper diagram	32
Figure 33: COM3 and COM4 voltage jumper diagram	33
Figure 34: COM5 and COM6 voltage jumper diagram	34
Figure 35: SATA DOM power jumper diagram	35
Figure 36: LVDS panel power jumper diagram	36
Figure 37: LVDS inverter power jumper diagram	37
Figure 38: DDR3 memory slot diagram	38
Figure 39: Unlocking the memory DIMM slot	39
Figure 40: Inserting the memory module	39
Figure 41: Locking the memory module	39
Figure 42: Removing the memory module	40
Figure 43: PCI slot diagram	41
Figure 44: Suggested minimum chassis dimensions	42
Figure 45: Suggested minimum internal chassis ceiling height	43
Figure 46: Suggested keepout areas	43
Figure 47: Illustration of the Main menu screen (for VB7009-16/VB7009-10E SKU)	45
Figure 48: Illustration of the Standard CMOS Features screen	47
Figure 49: Illustration of the IDE Channel 0 Master screen	48
Figure 50: Illustration of the IDE Channel 0 Slave screen	48
Figure 51: Illustration of the Advanced BIOS Features screen	50
Figure 52: Illustration of the CPU Feature screen	52
Figure 53: Illustration of the Hard Disk Boot Priority screen	53
Figure 54: Illustration of the Advanced Chipset Features screen	54
Figure 55: Illustration of the PCIE Bus Control screen	55
Figure 56: Illustration of the UMA & P2P Bridge Control screen	56
Figure 57: Illustration of the CPU & PCI Bus Control screen	57

Figure 58: Illustration of the Integrated Peripherals screen.....	58
Figure 59: Illustration of the VIA OnChip IDE Device screen	58
Figure 60: Illustration of the VIA OnChip PCI Device screen	59
Figure 61: Illustration of the SuperIO Device screen.....	60
Figure 62: Illustration of the USB Device Setting screen.....	61
Figure 63: Illustration of the Power Management Setup screen.....	62
Figure 64: Illustration of the Wakeup Event Detect screen	64
Figure 65: Illustration of the PnP/PCI Configurations screen	66
Figure 66: Illustration of the PC Health Status screen	67
Figure 67: Illustration of the Frequency/Voltage Control screen.....	68
Figure 68: Illustration of the Load Optimized Defaults screen	69
Figure 69: Illustration of the Set Supervisor/User Password screen	70
Figure 70: Illustration of the Save & Exit Setup screen.....	71
Figure 71: Illustration of the Exit Without Saving screen	71
Figure 72: Illustration of the Main menu screen (for VB7009-12QCE SKU)	72
Figure 73: Illustration of the Advanced Settings screen.....	73
Figure 74: Illustration of the CPU Configuration screen	74
Figure 75: Illustration of IDE Configuration screen.....	74
Figure 76: Illustration of SuperIO Configuration screen.....	75
Figure 77: Illustration of Hardware Health Configuration screen	76
Figure 78: Illustration of ACPI Configuration screen	77
Figure 79: Illustration of APM Configuration screen	78
Figure 80: Illustration of Spread Spectrum Configuration screen	80
Figure 81: Illustration of USB Configuration screen.....	81
Figure 82: Illustration of CRB Configuration screen.....	82
Figure 83: Illustration of Boot Settings screen.....	83
Figure 84: Illustration of Boot Settings Configuration screen.....	83
Figure 85: Illustration of Security Settings screen	85
Figure 86: Illustration of Advanced Chipset Settings screen.....	86
Figure 87: Illustration of North Bridge VIA VX900 Configuration screen	86
Figure 88: Illustration of DRAM Frequency/Timing Configuration screen	87
Figure 89: Illustration of OnChip VGA Configuration screen	88
Figure 90: Illustration of South Bridge VIA VX900 Configuration screen.....	89
Figure 91: Illustration of Exit Options screen	90
Figure 92: Installing the VIA EMIO-1533 module to the chassis	92
Figure 93: Connecting the USB Wi-Fi cable (VIA EMIO-1533).....	92
Figure 94: Installing Wi-Fi antenna cable (VIA EMIO-1533)	93
Figure 95: Connecting Wi-Fi antenna cable to the micro-RF connector (VIA EMIO-1533).....	93
Figure 96: Installing the VIA EMIO-5531 module to the chassis	94
Figure 97: Connecting the USB Wi-Fi cable (VIA EMIO-5531).....	94
Figure 98: Installing Wi-Fi antenna cable (VIA EMIO-5531)	95
Figure 99: Connecting Wi-Fi antenna cable to the micro-RF connector (VIA EMIO-5531).....	95

Lists of Tables

Table 1: PS/2 port pinouts	7
Table 2: VGA port pinouts.....	8
Table 3: COM port pinouts.....	8
Table 4: Parallel port pinouts	9
Table 5: Gigabit Ethernet port pinouts	10
Table 6: Gigabit Ethernet LED color definition	10
Table 7: USB 2.0 port pinouts	11
Table 8: Audio jack receptacle pinouts	11
Table 9: ATX power connector pinouts.....	12
Table 10: CMOS battery slot pinouts.....	13
Table 11: Front panel pin header pinouts	14
Table 12: Front audio pin header pinouts	15
Table 13: SMBus pin header pinout.....	16
Table 14: CPU and System fan connectors pinouts	17
Table 15: SATA connectors pinouts.....	18
Table 16: USB 2.0 pin header pinouts.....	19
Table 17: COM pin header pinouts	20
Table 18: PS/2 keyboard and mouse pin header pinouts	21
Table 19: LVDS panel connector pinouts (dual-channel).....	22
Table 20: LVDS panel connector pinouts (single-channel).....	23
Table 21: LVDS inverter connector pinouts	24
Table 22: S/PDIF connector pinouts.....	25
Table 23: SPI pin header pinouts.....	26
Table 24: LPC pin header pinouts	27
Table 25: Digital I/O pin header pinouts.....	28
Table 26: Temperature sensor pin header pinouts	29
Table 27: Clear CMOS jumper settings	31
Table 28: COM2 voltage jumper settings	32
Table 29: COM3 and COM4 voltage jumper settings.....	33
Table 30: COM5 and COM6 voltage jumper settings.....	34
Table 31: SATA DOM power jumper settings	35
Table 32: LVDS panel power jumper settings.....	36
Table 33: LVDS inverter power jumper settings	37
Table 34: Serial port addresses and IRQs	75
Table 35: VIA VB7009 mating connector vendors list	104

1. Product Overview

The VIA VB7009 is an entry-level native x86 board designed mainly for embedded and thin client applications. It can also be used for various domain applications such as desktop PC, industrial PC, etc. The VIA VB7009 is based on the VIA VX900 MSP that features the VIA C-9 HD DX9 with 3D/2D graphics and video accelerators for rich digital media performance.

The VIA VB7009 includes a secure and power efficient VIA C7[®]-D / C7[®] / Eden[®] X4 processor. The VIA C7[®]-D / C7[®] / Eden[®] X4 processor includes the VIA Padlock Security Engine, VIA StepAhead™ Technology Suite, VIA PowerSaver™ and VIA CoolStream™ technology.

The VIA VB7009 has one 1066MHz DDR3 DIMM slot that supports up to 4GB memory size. The VIA VB7009 provides support for high fidelity audio with its included VIA VT1708S High Definition Audio codec. In addition it supports two SATA 3Gb/s storage devices.

The VIA VB7009 is compatible with a full range of Mini-ITX chassis as well as FlexATX and MicroATX enclosures and power supplies. The VIA VB7009 is fully compatible with Microsoft[®] and Linux operating systems.

1.1. Key Features and Benefits

1.1.1. VIA C7[®]-D / C7[®] / Eden[®] X4 Processor

The VIA C7[®]-D / C7[®] / Eden[®] X4 is an x86 processor packed into an ultra-compact package (measuring 21mm x 21mm). It delivers an energy-efficient yet powerful performance, with cool and quiet operation that makes it ideal for embedded system applications.

The VIA C7[®]-D / C7[®] is a single core 32-bit processor based on 90nm process technology, and it is the world's first Carbon Free processor.

The VIA Eden[®] X4 processor is a new processor generation, designed for high performance computing, surpassing the existing VIA QuadCore. The VIA Eden[®] X4 processor is a multi-core, super scalar, out-of-order architecture and is manufactured using advanced 28nm CMOS technology. This architecture and process technology provides a highly compatible, high-performance, and low-power consumption solution for any computing market.

1.1.2. VIA VX900 MSP

The VIA VX900 MSP is designed to enable high quality digital video streaming and DVD playback in a new generation of fanless, small form factor PCs and IA devices. The VIA VX900 MSP features VIA C-9 HD DX9 with 3D/2D graphics and video acceleration, DDR3 1066/800 support, motion compensation and dual display support to ensure a rich overall entertainment experience.

1.1.3. Modular Expansion Options

The VIA VB7009 ensures long-term usability with its support for industry standard expansion options. Its support for legacy PCI expansion cards helps to smooth and reduce the costs of transitioning to newer expansion technologies. The VIA VB7009 enables companies to slowly roll out upgrades as necessary instead of having to replace everything all at once. This ensures that companies using the VIA VB7009 obtain the maximum benefits from its past investments in PCI expansion cards.

1.2. Product Specifications

- **Processor**
 - 1.6 GHz VIA C7[®]-D (for VB7009-16 SKU) – with fan
 - 1.0GHz VIA C7[®] (for VB7009-10E SKU) – fanless
 - 1.2GHz VIA Eden[®] X4 (for VB7009-12QCE SKU) – fanless
- **Chipset**
 - VIA VX900 Media System Processor
- **BIOS**
 - AMI BIOS, 8Mbit Flash memory
- **System Memory**
 - 1 x DDR3 1066 slot
 - Supports up to 4GB memory size
- **Storage**
 - 2 x SATA connectors
- **Graphics**
 - Integrated VIA C-9 HD DX9 3D/2D AGP graphics with MPEG-2, WMV9, VC-1, and H.264 video decoding acceleration
- **LAN**
 - 2 x VIA VT6130 PCIe Gigabit Ethernet controllers
- **Audio**
 - VIA VT1708S High Definition Audio Codec
- **SuperIO**
 - Fintek F81865F-1
- **Expansion I/O**
 - 1 x PCI slot
- **Onboard I/O Connectors**
 - 2 x USB 2.0 pin headers for 4 USB ports
 - 2 x SATA connectors
 - 1 x Front audio pin header for Line-out and Mic-in
 - 1 x Front panel pin header
 - 1 x PS/2 keyboard and mouse pin header
 - 1 x Digital I/O pin header (4 GPI + 4 GPO)
 - 1 x CPU fan connector
 - 1 x System fan connector
 - 3 x COM pin headers (powered with selectable 5V/12V) (available only for VB7009-16 & VB7009-10E SKU)
 - 5 x COM pin headers (powered with selectable 5V/12V) (available only for VB7009-12QCE SKU)
 - 1 x PCI slot
 - 1 x Dual-channel 18/24 bit LVDS panel connector
 - 1 x LVDS inverter connector
 - 1 x LPC pin header
 - 1 x S/PDIF connector
 - 1 x SPI pin header
 - 1 x SMBus pin header
 - 1 x Temperature sensor pin header
 - 1 x ATX power connector (20-pin)
 - 1 x Buzzer

- **Onboard Jumper**
 - 1 x Clear CMOS jumper
 - 1 x COM2 voltage jumper
 - 1 x COM3 and COM4 voltage jumper
 - 1 x COM5 and COM6 voltage jumper (available only for VB7009-12QCE SKU)
 - 1 x SATA DOM power jumper
 - 1 x LVDS panel power jumper (5V/3.3V)
 - 1 x LVDS inverter power jumper (5V/12V)
- **Back Panel I/O**
 - 1 x VGA port
 - 1 x COM port
 - 1 x Parallel port
 - 2 x Gigabit Ethernet ports
 - 4 x USB 2.0 ports
 - 2 x PS/2 keyboard/mouse port
 - 3 x Audio jacks: Line-in, Line-out, and Mic-in
- **Power Supply**
 - ATX power connector
- **Operating System**
 - Windows 7
 - Windows Embedded Standard 7
 - Windows Embedded POSReady 7
 - Windows CE
 - Linux
- **System Monitoring & Management**
 - Wake-on LAN
 - Wake-on keyboard
 - Wake-on mouse
 - RTC timer to power on
 - AC power failure recovery
- **Operating Temperature**
 - 0°C ~ 60°C
- **Operating Humidity**
 - 0% ~ 95% (non-condensing)
- **Form Factor**
 - Mini-ITX (17cm x 17cm, 6.7" x 6.7")
- **Compliance**
 - CE
 - FCC

Note:

As the operating temperature provided in the specifications is a result of testing performed in a testing chamber, a number of variables can influence this result. Please note that the working temperature may vary depending on the actual situation and environment. It is highly recommended to execute a solid testing program and take all variables into consideration when building the system. Please ensure that the system is stable at the required operating temperature in terms of application.

1.3. Layout Diagram

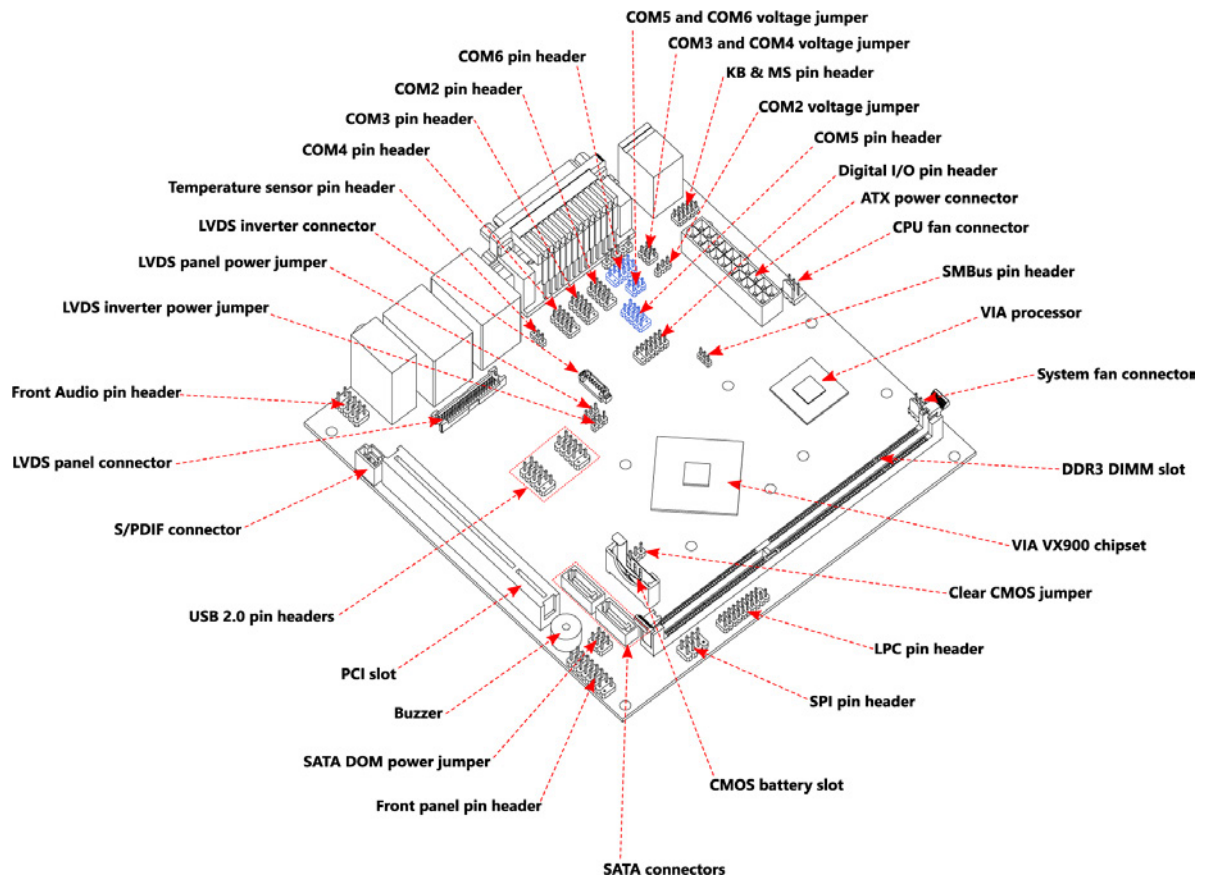

Figure 1: Layout diagram of the VIA VB7009 board (top side)



Note:

The additional COM pin headers labeled "COM5" and "COM6" are available only in the VB7009-12QCE SKU.

1.4. Product Dimensions

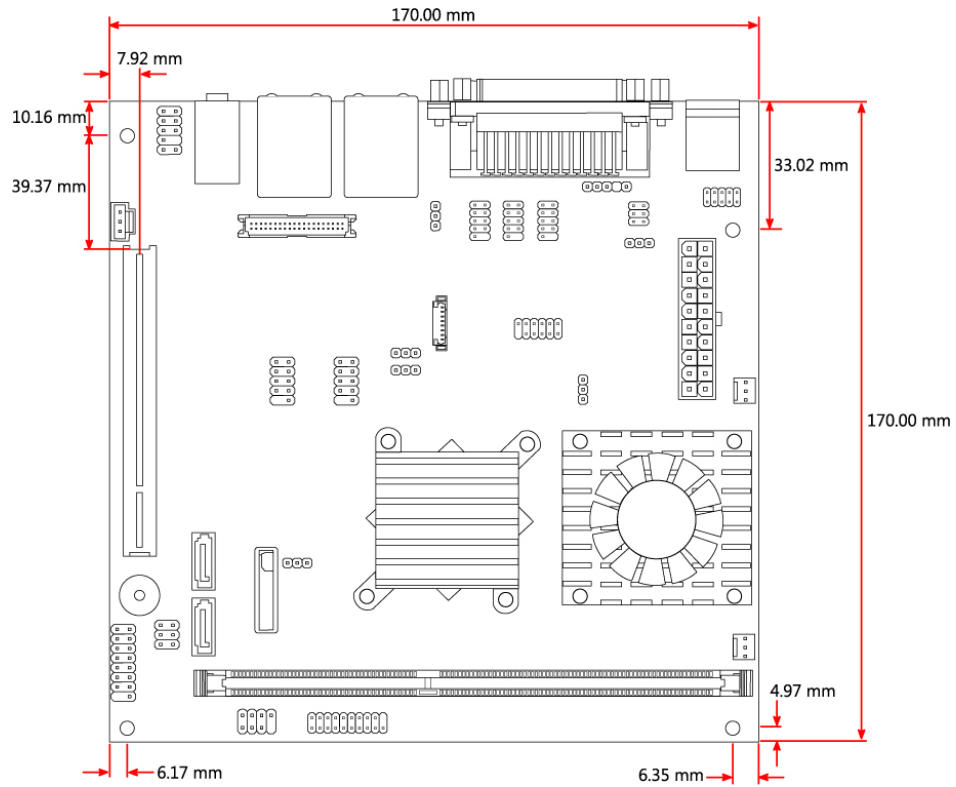

Figure 2: Mounting holes and dimensions of the VIA VB7009

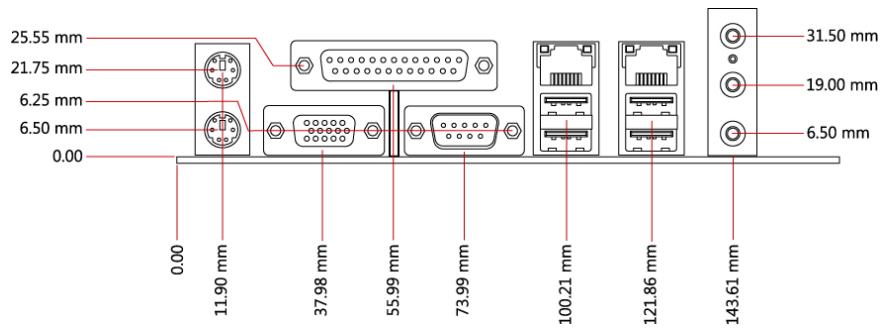

Figure 3: External I/O port dimensions of the VIA VB7009

1.5. Height Distribution

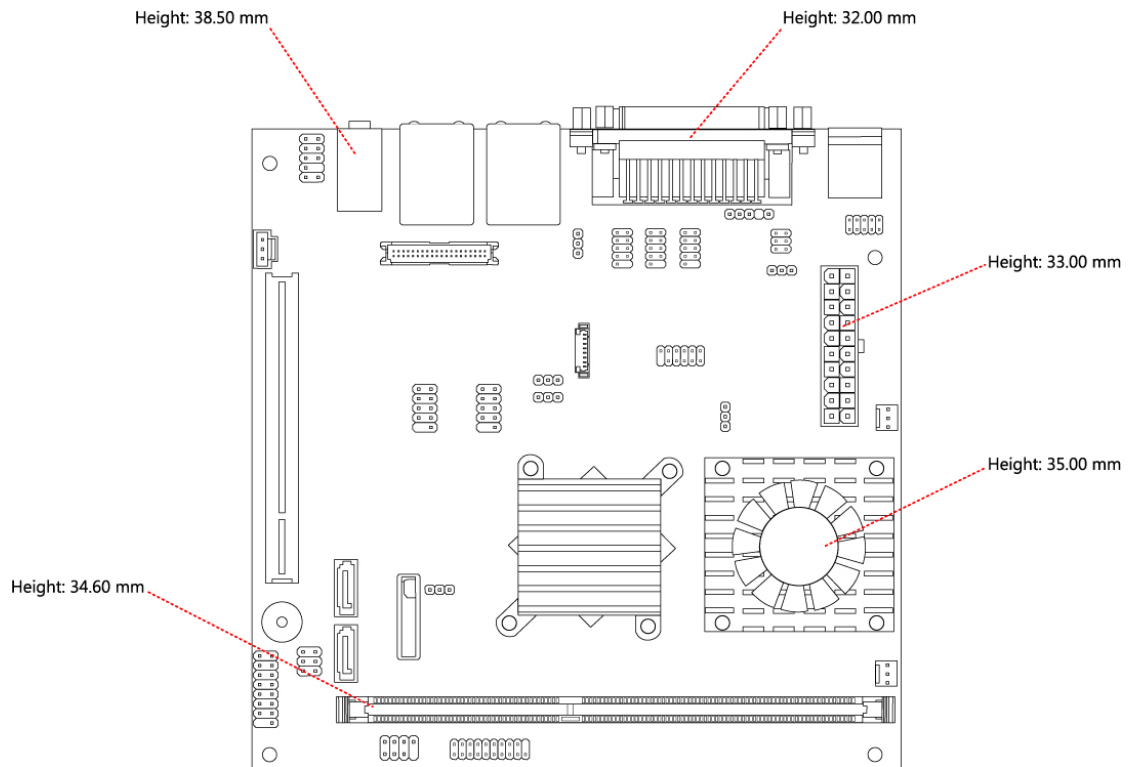

Figure 4: Height distribution of the VIA VB7009 (for fan model)

2. I/O Interface

The VIA VB7009 has a wide selection of interfaces, and includes a selection of frequently used ports as part of the external I/O coastline.

2.1. External I/O Ports

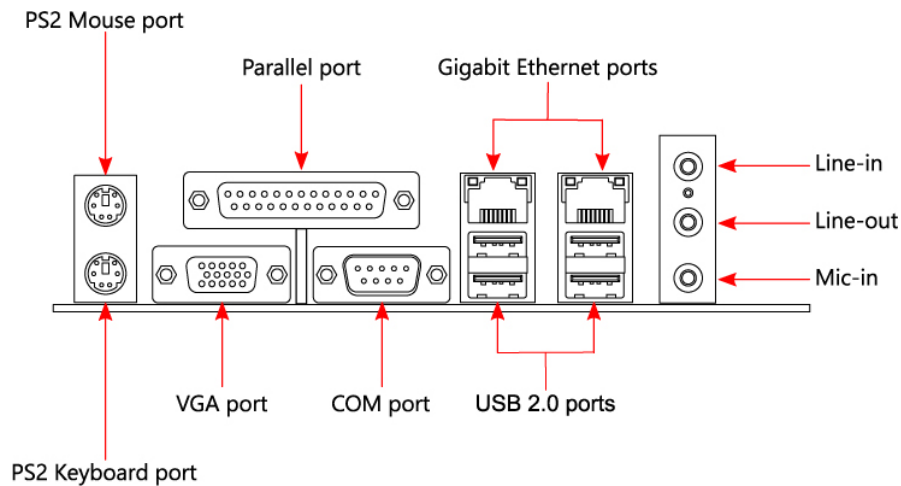

Figure 5: Back panel I/O ports

2.1.1. PS/2 Ports

The VIA VB7009 has two integrated PS/2 ports for a keyboard and mouse. Each port is using the 6-pin Mini-DIN connector. The color purple is use for a PS/2 keyboard while the color green is use for a PS/2 mouse. The pinouts of the PS/2 ports are shown below.

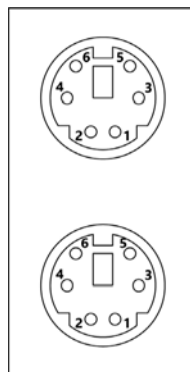

Figure 6: PS/2 ports diagram

Pin	Signal
1	Data
2	NC
3	GND
4	+5V
5	Clock
6	NC

Table 1: PS/2 port pinouts

2.1.2. VGA Port

The integrated 15-pin VGA port uses a female DE-15 connector. The VGA port is for connecting to analog displays. The pinouts of the VGA port are shown below.

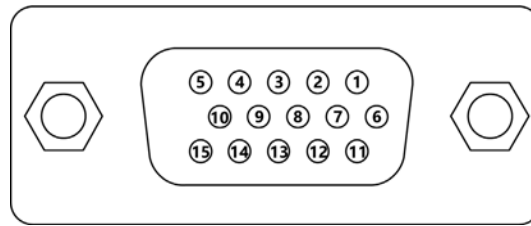

Figure 7: VGA port diagram

Pin	Signal	Pin	Signal
1	VGA-R	9	+5V
2	VGA-G	10	GND
3	VGA-B	11	NC
4	NC	12	VGA-SPD
5	GND	13	VGA_HS
6	GND	14	VGA_VS
7	GND	15	VGA-SPCLK
8	GND		

Table 2: VGA port pinouts

2.1.3. COM Port

The integrated 9-pin COM port uses a male DE-9 connector. The COM (COM1) port supports the RS-232 standard. The pinouts of the COM port are shown below.

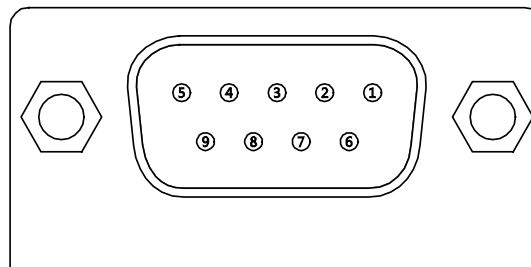

Figure 8: COM port diagram

Pin	Signal	Pin	Signal
1	RIN11/-DCD1	6	RIN21/-DSR1
2	RIN31/SIN1	7	DOUT11/-RTS1
3	DOUT21/SOUT1	8	RIN41/-CTS1
4	DOUT31/-DTR1	9	-XRI1/-RI1
5	GND		

Table 3: COM port pinouts

2.1.4. Parallel Port

The integrated 25-pin parallel port uses a female DB-25 connector. A parallel port is a standard printer port that supports Enhanced Parallel Port (EPP) and Extended Capabilities Parallel Port (ECP) modes. The pinouts of the Parallel port are shown below.

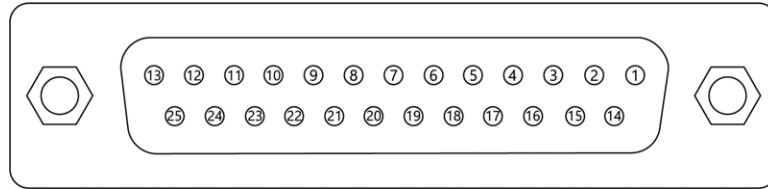

Figure 9: Parallel port diagram

Pin	Signal	Pin	Signal
1	-LPSTB	14	-LPAFD
2	LPD0	15	-LPERR
3	LPD1	16	-LPINIT
4	LPD2	17	-LPSLIN
5	LPD3	18	GND
6	LPD4	19	GND
7	LPD5	20	GND
8	LPD6	21	GND
9	LPD7	22	GND
10	-LPACK	23	GND
11	LPBUSY	24	GND
12	LPPE	25	GND
13	LPSLCT		

Table 4: Parallel port pinouts

2.1.5. Gigabit Ethernet Port

The integrated 8-pin Gigabit Ethernet port is using an 8 Position 8 Contact (8P8C) receptacle connector commonly known as RJ-45. The pinouts of the Gigabit Ethernet port are shown below.

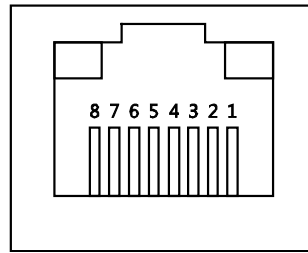

Figure 10: Gigabit Ethernet port diagram

Pin	Signal
1	Signal pair 1+
2	Signal pair 1-
3	Signal pair 2+
4	Signal pair 3+
5	Signal pair 3-
6	Signal pair 2-
7	Signal pair 4+
8	Signal pair 4-

Table 5: Gigabit Ethernet port pinouts

Each Gigabit Ethernet port has two individual LED indicators located on the front side to show its Active/Link status and Speed status.

	Link LED (Left LED on RJ-45 connector)	Active LED (Right LED on RJ-45 connector)
Link Off	Off	Off
Speed_10Mbit	The LED is always On and flashing in colors Green and Orange	Flash in Yellow color
Speed_100Mbit	The LED is always On in Green color	Flash in Yellow color
Speed_1000Mbit	The LED is always On in Orange color	Flash in Yellow color

Table 6: Gigabit Ethernet LED color definition

2.1.6. USB 2.0 Ports

The VIA VB7009 is equipped with two USB 2.0 ports which gives complete Plug and Play and hot swap capability for external devices. The USB 2.0 interface complies with USB UHCI, Rev. 2.0. The pinouts of the USB 2.0 port are shown below.

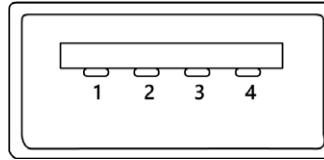

Figure 11: USB 2.0 port diagram

Pin	Signal
1	+5VSUS
2	Data-
3	Data+
4	GND

Table 7: USB 2.0 port pinouts

2.1.7. Audio Jacks

There are three audio jack receptacles integrated into a single stack on the I/O coastline. Each receptacle can fit a 3.5mm Tip Ring Sleeve (TRS) connector to enable connections to Line-out Line-in, and Mic-in. The Line-out jack is for connecting to external speakers or headphones. The Line-In jack is for connecting external audio devices such as CD player, tape player and etc. The Mic-in jack is for connecting to a microphone.

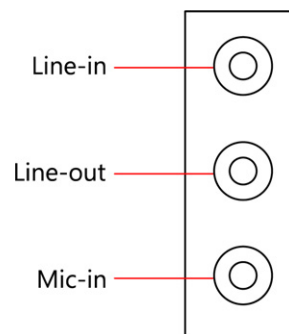

Figure 12: Audio jack receptacle stack diagram

Wiring	Line-in	Line-out	Mic-in
Tip	Left channel in	Left channel	Left channel
Ring	Right channel in	Right channel	Right channel
Sleeve	GND	GND	GND

Table 8: Audio jack receptacle pinouts

2.2. Onboard IO

2.2.1. ATX Power Connector

The VIA VB7009 has a 20-pin ATX power connector. The ATX power connector is labeled as "ATX_POWER1". The pinouts of the ATX power connector are shown below.

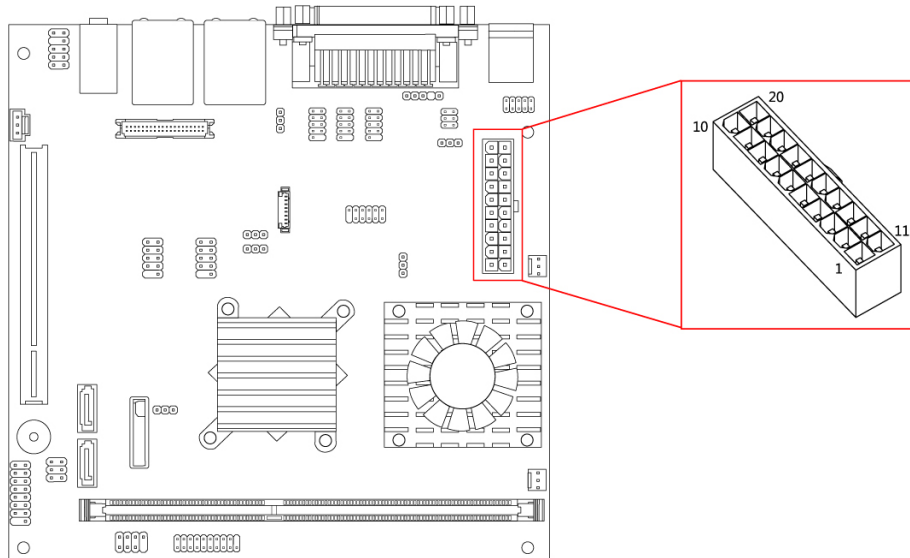

Figure 13: ATX power connector diagram

Pin	Signal	Pin	Signal
1	+3.3V	11	+3.3V
2	+3.3V	12	-12V
3	GND	13	GND
4	+5V	14	Power Supply On
5	GND	15	GND
6	+5V	16	GND
7	GND	17	GND
8	Power OK	18	NC
9	+5VSUS	19	+5V
10	+12V	20	+5V

Table 9: ATX power connector pinouts

2.2.2. CMOS Battery Slot

The VIA VB7009 is equipped with a CMOS battery slot, which is compatible with CR2032 coin batteries. This CMOS battery slot is labeled as "BAT2". When inserting a CR2032 coin battery, be sure that the positive side is facing the locking clip. The pinouts of the CMOS battery slot are shown below.

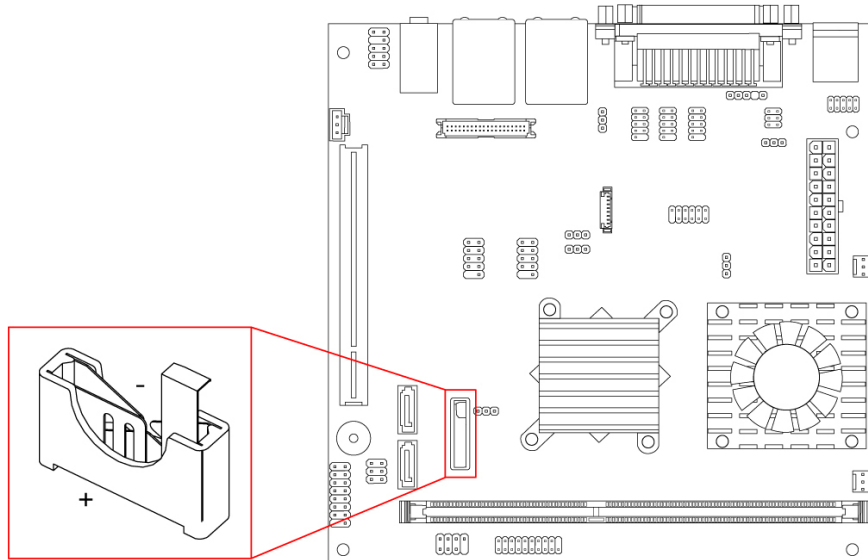

Figure 14: CMOS battery slot diagram

Pin	Signal
1	GND
2	+3V
3	GND

Table 10: CMOS battery slot pinouts

2.2.3. Front Panel Pin Header

The front panel pin header consists of 15 pins in a 16-pin block. Pin 15 is keyed. The front panel pin header is labeled as "F_PANEL1". It provides access to system LEDs, power, reset, system speaker and HDD LED. The pinouts of the front panel pin header are shown below.

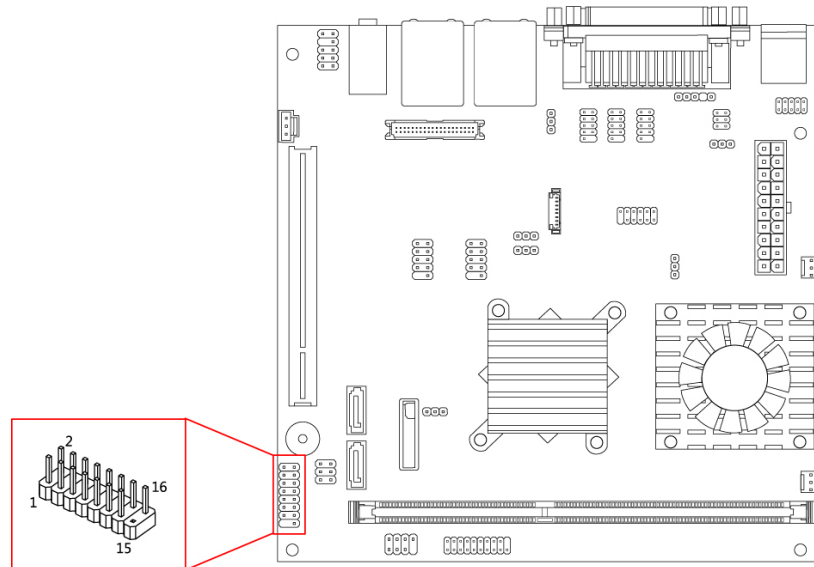

Figure 15: Front panel pin header diagram

Pin	Signal	Pin	Signal
1	+5VDUAL	2	+5V
3	+5VDUAL	4	SATA_LED
5	PWR_LED	6	PWR_BTN
7	+5V	8	GND
9	NC	10	-RST_SW
11	NC	12	GND
13	SPEAK	14	+5V
15	Key	16	-SLEEP_LED

Table 11: Front panel pin header pinouts

2.2.4. Front Audio Pin Header

In addition to the TRS audio jacks on the external I/O coastline, the VIA VB7009 has a pin header for Line-out and Mic-in. The pin header is labeled as "F_AUDIO1". The pinouts of the pin header are shown below.

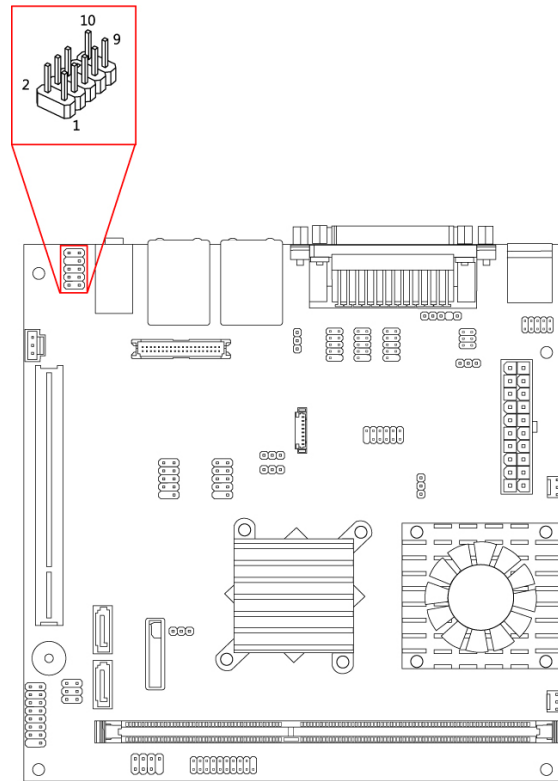

Figure 16: Front audio pin header diagram

Pin	Signal	Pin	Signal
1	MIC2IN_L	2	AGND
3	MIC2IN_R	4	AGND
5	HPOUTR	6	MIC2_JD
7	F_AUDIO_SENSE	8	Key
9	HPOUTL	10	HPOUT_JD

Table 12: Front audio pin header pinouts

2.2.5. SMBus Pin Header

The SMBus pin header consists of three pins that allow connecting the SMBus devices. Devices communicate with an SMBus host and/or other SMBus devices using the SMBus interface. It is labeled as "SMBUS1". The pinouts of the SMBus pin header are shown below.

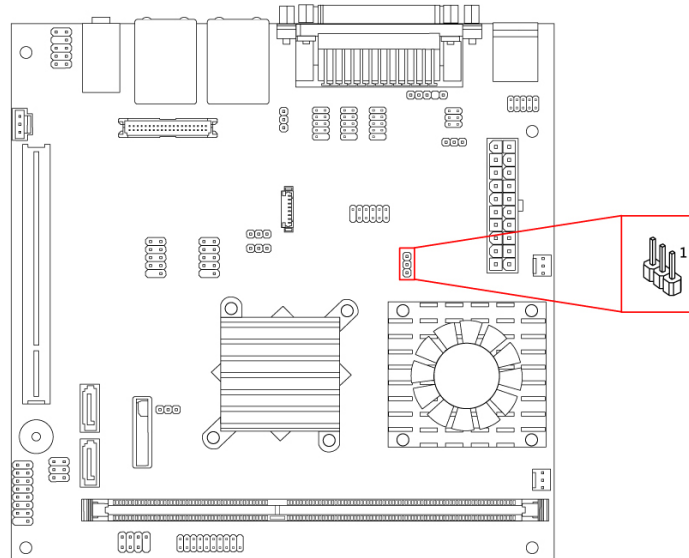

Figure 17: SMBus pin header diagram

Pin	Signal
1	SMB_CK
2	SMB_DT
3	GND

Table 13: SMBus pin header pinout

2.2.6. CPU and System Fan Connectors

There are two fan connectors on board: one for the CPU and one for the chassis. The fan connector for the CPU is labeled as "CPUFAN1" and the fan connector for the system is labeled as "SYSFAN1". The fans provide variable fan speeds controlled by the BIOS. The pinouts of the fan connectors are shown below.

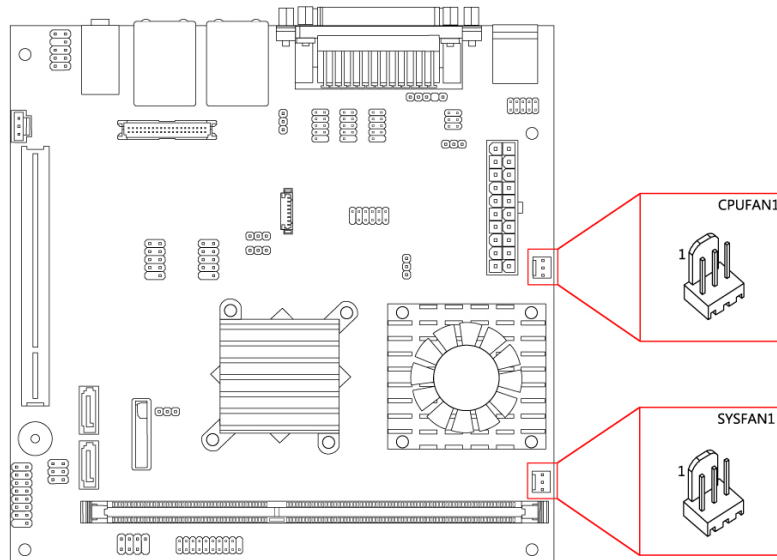

Figure 18: CPU and System fan connectors diagram

CPU fan (CPUFAN1)	
Pin	Signal
1	F_IO2 / Fan speed detection
2	F_PWM2 / Fan speed control
3	GND

System fan (SYSFAN1)	
Pin	Signal
1	F_IO1 / Fan speed detection
2	F_PWM1 / Fan speed control
3	GND

Table 14: CPU and System fan connectors pinouts

2.2.7. SATA Connectors

The two SATA connectors on board can support up to 3 Gb/s transfer speeds. The SATA connectors are labeled as "SATA1" and "SATA2". The pinouts of the SATA connectors are as shown below.

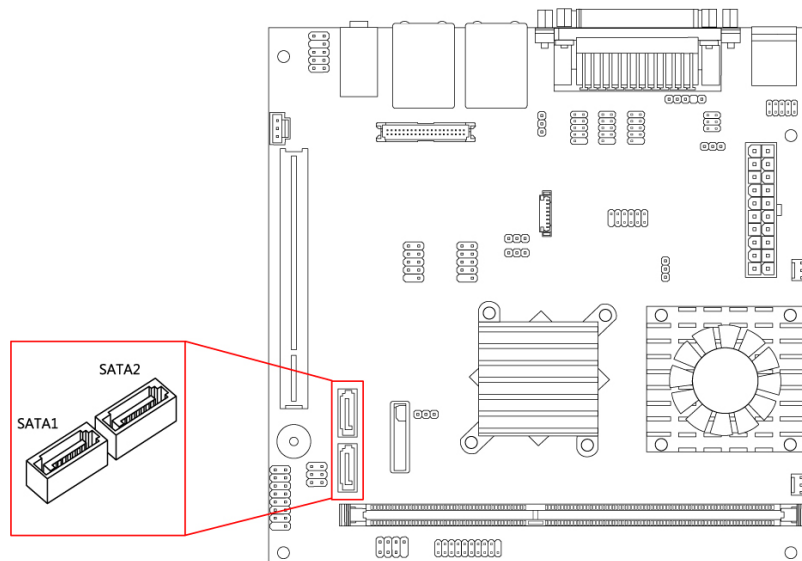

Figure 19: SATA connectors diagram

SATA1		SATA2	
Pin	Signal	Pin	Signal
1	GND	1	GND
2	STXP_0	2	STXP_1
3	STXN_0	3	STXN_1
4	GND	4	GND
5	SRXN_0	5	SRXN_1
6	SRXP_0	6	SRXP_1
7	GND/+5V	7	GND/+5V

Table 15: SATA connectors pinouts



Notes:

SATA connector pin 7:

1. GND is for SATA HDD (default setting).
2. +5V is for SATA DOM. To enable the +5V on pin 7, set the SATA DOM voltage jumper.

2.2.8. USB 2.0 Pin Headers

The VIA VB7009 has two USB 2.0 pin headers blocks that support up to four USB 2.0 ports. The pin header blocks are labeled as USB_4, and "USB_5". The pinouts of the USB 2.0 pin headers are shown below.

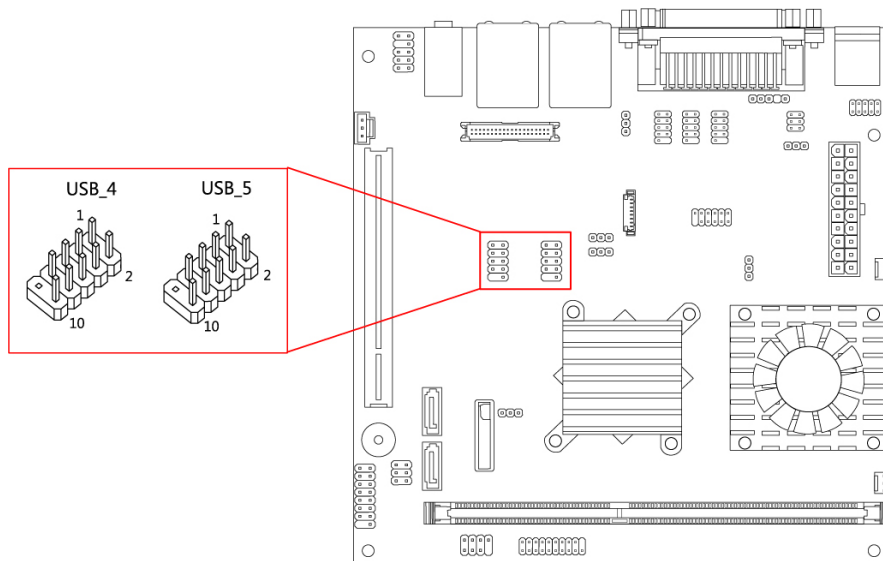

Figure 20: USB 2.0 pin header diagram

USB_4			
Pin	Signal	Pin	Signal
1	+5VDUAL	2	+5VDUAL
3	USBD_T1-	4	USBD_T0-
5	USBD_T1+	6	USBD_T0+
7	GND	8	GND
9	Key	10	GND

USB_5			
Pin	Signal	Pin	Signal
1	+5VDUAL	2	+5VDUAL
3	USBD_T6-	4	USBD_T7-
5	USBD_T6+	6	USBD_T7+
7	GND	8	GND
9	Key	10	GND

Table 16: USB 2.0 pin header pinouts

2.2.9. COM Pin Headers

There are COM pin headers on the VIA VB7009 in addition to the COM port 1 on the external I/O. Each COM pin header supports RS-232 standard. The COM pin headers labeled as "COM2, COM3 and COM4" are available in the VB7009-16 and VB7009-10E SKUs, while the additional "COM5" and "COM6" pin headers are offered only by VB7009-12QCE SKUs. All the COM pin headers can support +5V or +12V. See page 32 for details on setting the voltage. The pinouts of the COM pin headers are shown below.

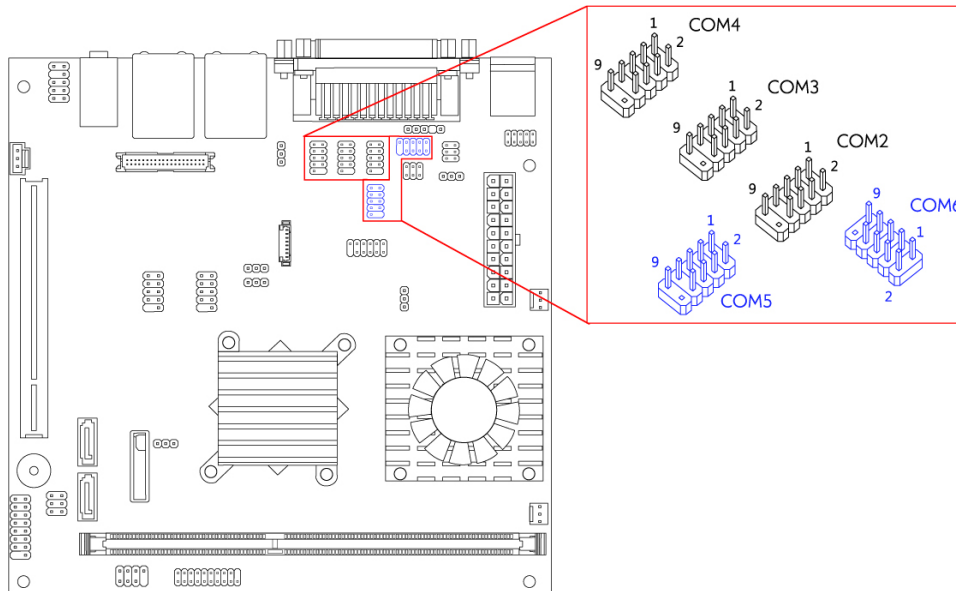

Figure 21: COM pin headers diagram

Pin	Signal	Pin	Signal
1	COM_DCD	2	COM_RXD
3	COM_TXD	4	COM_DTR
5	GND	6	COM_DSR
7	COM_RTS	8	COM_CTS
9	COM_RI	10	Key

Table 17: COM pin header pinouts

2.2.10. PS/2 Keyboard and Mouse Pin Header

The VIA VB7009 has a pin header for PS/2 keyboard and mouse. The pin header is labeled as "JKB/MS1". The pinouts of the pin header are shown below.

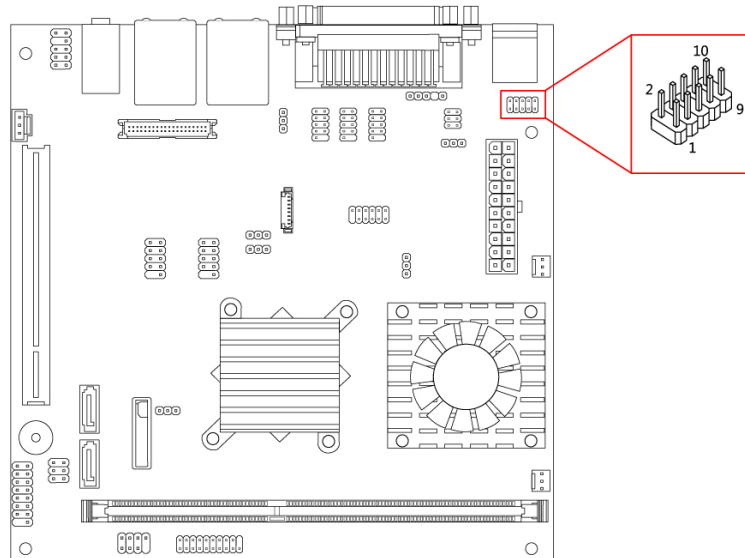

Figure 22: PS/2 keyboard and mouse pin header diagram

Pin	Signal	Pin	Signal
1	+5VDUAL	2	GND
3	KB_CLK	4	KB_DATA
5	EKBCLK	6	EKBDATA
7	MS_CLK	8	MS_DATA
9	EMSCLK	10	EMSDATA

Table 18: PS/2 keyboard and mouse pin header pinouts



Note:

When the pin header is not in use, please short pin 3&5, pin 4&6, pin 7&9 and pin 8&10

2.2.11. LVDS Panel Connector

The VIA VB7009 has one 40-pin LVDS panel connector on the bottom side. It can support one dual-channel LVDS or one single-channel LVDS. The LVDS panel connector is labeled as “PANEL_CONN1”. The pinouts of the connector are shown below.

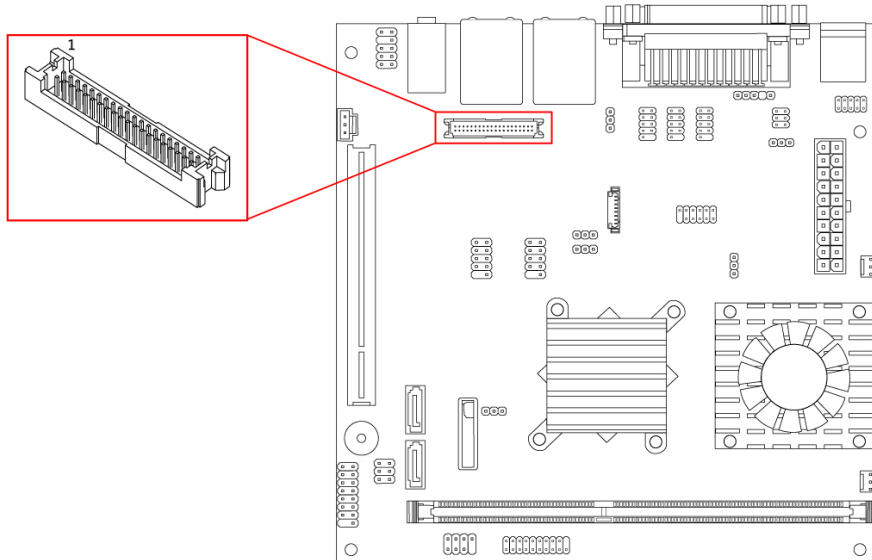

Figure 23: LVDS panel connector diagram

Pin	Signal	Pin	Signal
1	-A4_L	2	PVDD
3	A4_L	4	PVDD
5	GND	6	GND
7	-A5_L	8	GND
9	A5_L	10	-A0_L
11	GND	12	A0_L
13	-A6_L	14	GND
15	A6_L	16	-A1_L
17	GND	18	A1_L
19	-CLK2_L	20	GND
21	CLK2_L	22	-A2_L
23	GND	24	A2_L
25	-A7_L	26	GND
27	A7_L	28	-CLK1_L
29	NC	30	CLK1_L
31	NC	32	GND
33	NC	34	-A3_L
35	NC	36	A3_L
37	NC	38	SPCLK1
39	NC	40	SPD1

Table 19: LVDS panel connector pinouts (dual-channel)

Pin	Signal	Pin	Signal
1	NC	2	PVDD
3	NC	4	PVDD
5	NC	6	GND
7	NC	8	GND
9	NC	10	-A0_L
11	NC	12	A0_L
13	NC	14	GND
15	NC	16	-A1_L
17	NC	18	A1_L
19	NC	20	GND
21	NC	22	-A2_L
23	NC	24	A2_L
25	NC	26	GND
27	NC	28	-CLK1_L
29	NC	30	CLK1_L
31	NC	32	GND
33	NC	34	-A3_L
35	NC	36	A3_L
37	NC	38	SPCLK1
39	NC	40	SPD1

Table 20: LVDS panel connector pinouts (single-channel)

2.2.12. LVDS Inverter Connector

The VIA VB7009 has one LVDS inverter connector on the bottom side. The LVDS inverter connector is labeled as "INVERTER1". The pinouts of the connector are shown below.

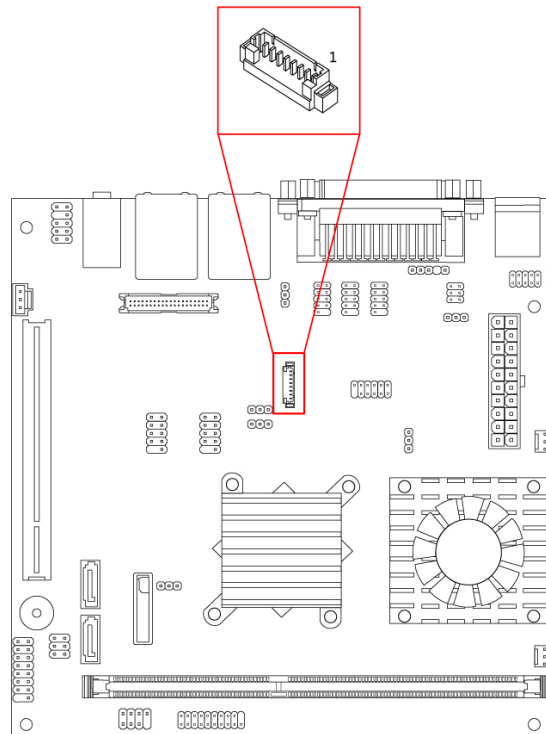

Figure 24: LVDS inverter connector diagram

Pin	Signal
1	IVDD
2	IVDD
3	BAKLITE_EN
4	LVDS_PWM
5	BAKLITE_EN
6	LVDS_DA
7	GND
8	GND

Table 21: LVDS inverter connector pinouts

2.2.13. S/PDIF Connector

The VIA VB7009 has one 3-pin S/PDIF (Sony/Philips Digital Interface Format) connector. The S/PDIF output provides digital audio to external speakers or compressed AC3 data to an external Dolby Digital Decoder. The connector is labeled as "S/PDIF". The pinouts of the connector are shown below.

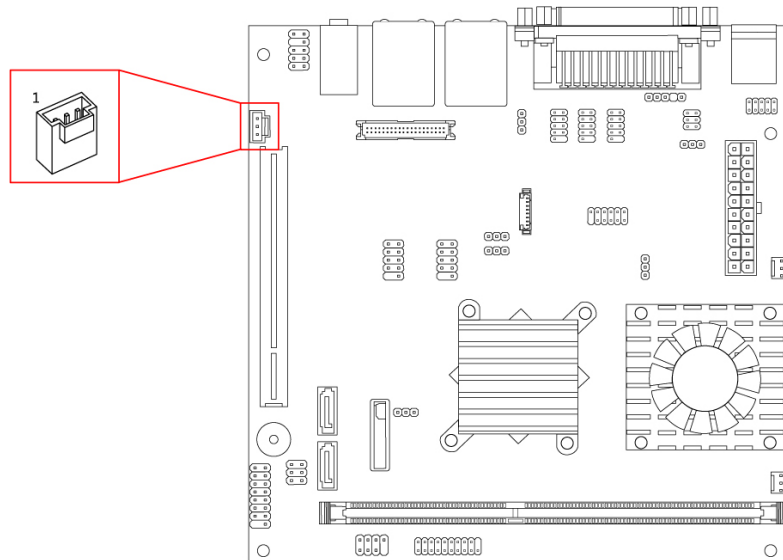

Figure 25: S/PDIF connector diagram

Pin	Signal
1	+5V
2	SPDIFO
3	GND

Table 22: S/PDIF connector pinouts

2.2.14. SPI Pin Header

The VIA VB7009 has one 8-pin SPI pin header. The SPI (Serial Peripheral Interface) pin-header is used to connect to the SPI BIOS programming fixture. The pin header is labeled as "SPI1". The pinouts of the pin header are shown below.

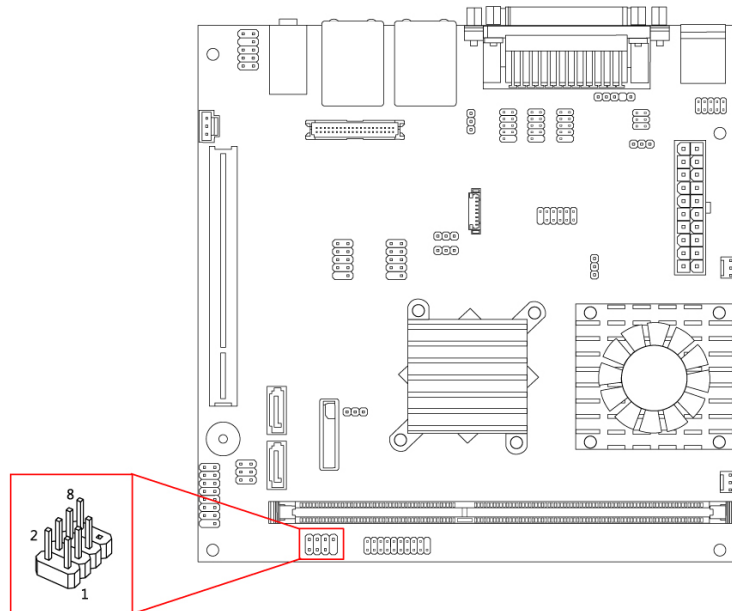

Figure 26: SPI pin header diagram

Pin	Signal	Pin	Signal
1	SPIVCC	2	GND
3	MSPISS0	4	MSPICLK
5	MSPIDI	6	MSPIDO
7	Key	8	-PCIRST

Table 23: SPI pin header pinouts

2.2.15. LPC Pin Header

The VIA VB7009 has one LPC pin header for connecting LPC devices. The pin header is labeled as "LPC1". The pinouts of the pin header are shown below.

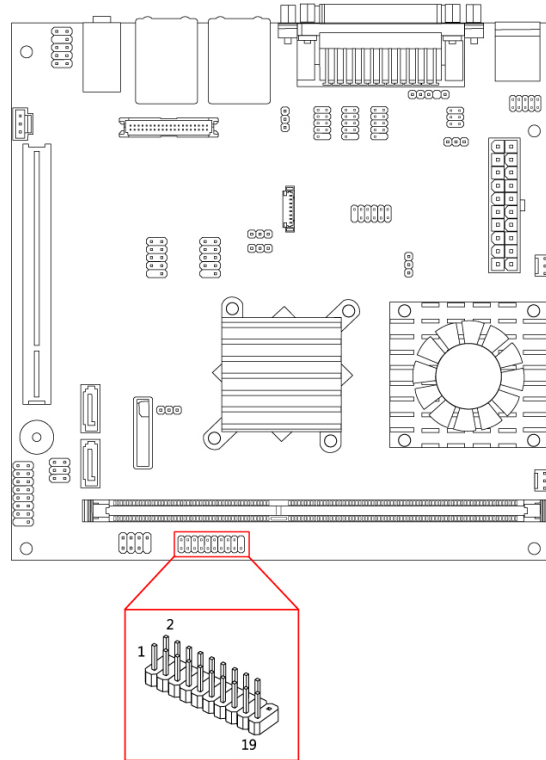

Figure 27: LPC pin header diagram

Pin	Signal	Pin	Signal
1	LPCAD1	2	LPC33CLK
3	-LPCRST	4	GND
5	LPCAD0	6	LPC48CLK
7	LPCAD2	8	-LPCFRAME
9	SERIRQ	10	LPCAD3
11	-LPCDRQ1	12	-EXTSMI
13	+5V	14	+3.3V
15	+5V	16	+3.3V
17	GND	18	GND
19	GND	20	Key

Table 24: LPC pin header pinouts

2.2.16. Digital I/O Pin Header

The VIA VB7009 includes one Digital I/O pin header that supports up to four GPO and four GPI signals. The pin header is labeled as "DIO1". The pinouts of the pin headers are shown below.

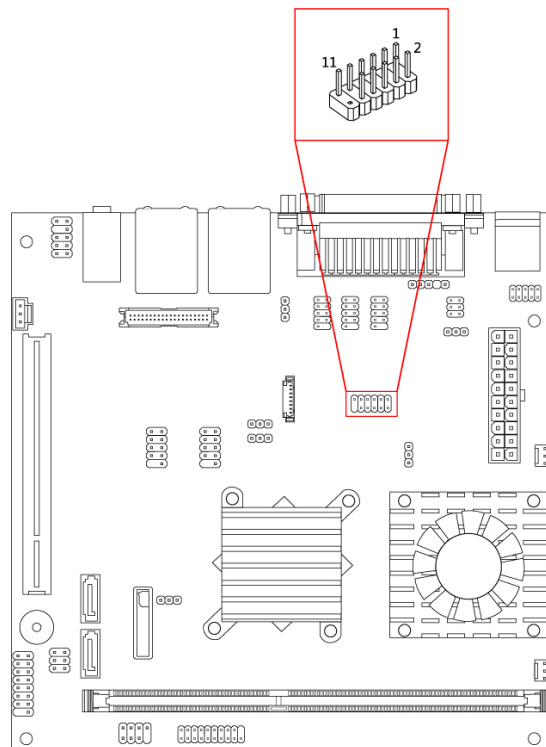

Figure 28: Digital I/O pin header diagram

Pin	Signal	Pin	Signal
1	+5V	2	+12V
3	GPO_23	4	GPI_03
5	GPO_22	6	GPI_02
7	GPO_21	8	GPI_01
9	GPO_20	10	GPI_00
11	GND	12	Key

Table 25: Digital I/O pin header pinouts

2.2.17. Temperature Sensor Pin Header

The VIA VB7009 supports a pin header (3-pin) that allows the connection of a temperature sensor cable for detecting the system's internal air temperature. The temperature reading can be seen in the BIOS Setup Utility. The pin header is labeled as "J5". The pinouts of the temperature sensor pin header are shown below.

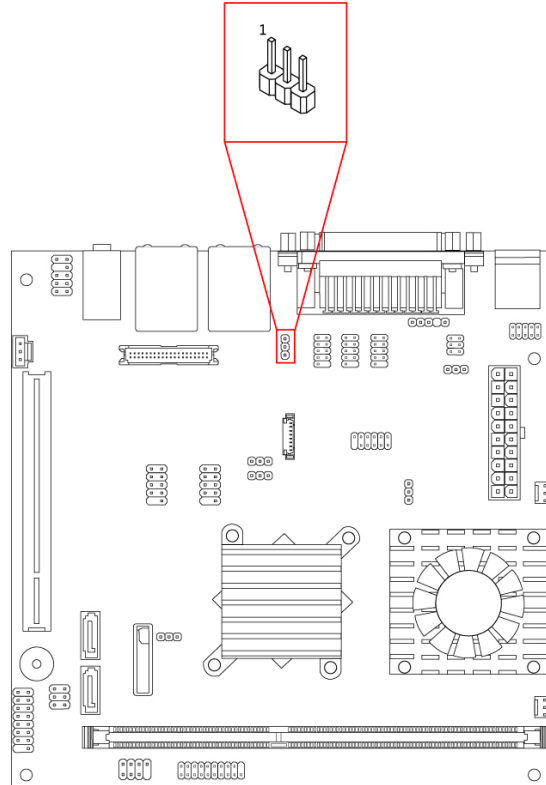

Figure 29: Temperature sensor pin header diagram

Pin	Signal
1	TMPIN2
2	TMPIN2
3	HWMGND

Table 26: Temperature sensor pin header pinouts

3. Jumpers

This section will explain how to configure the VIA VB7009 to match the needs of your application by setting the jumpers.

Jumper Description

A jumper consists of pair conductive pins used to close in or bypass an electronic circuit to set up or configure particular feature using a jumper cap. The jumper cap is a small metal clip covered by plastic. It performs like a connecting bridge to short (connect) the pair of pins. The usual colors of the jumper cap are black/red/blue/white/yellow.

Jumper Setting

There are two settings of the jumper pin: “**Short** and **Open**”. The pins are “**Short**” when a jumper cap is placed on the pair of pins. The pins are “**Open**” if the jumper cap is removed.

In addition, there are jumpers that have three or more pins, and some pins are arranged in series. In case of a jumper with three pins, place the jumper cap on pin 1 and pin 2 or pin 2 and 3 to Short it.

Some jumpers size are small or mounted on the crowded location of the board that makes it difficult to access. Therefore, using a long-nose plier in installing and removing the jumper cap is very helpful.

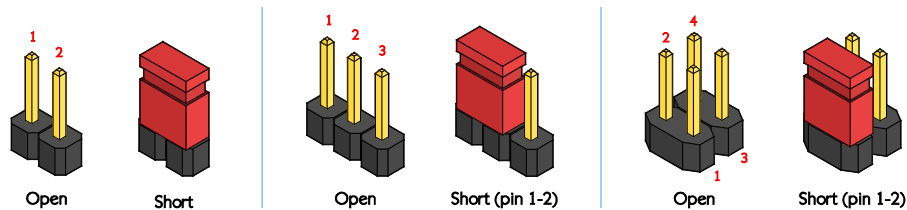

Figure 30: Jumper settings example



Caution:

Make sure to install the jumper cap on the correct pins. Installing it in the wrong pin might cause damage and malfunction.

3.1. Clear CMOS Jumper

The VIA VB7009 comes with a Clear CMOS jumper. The onboard CMOS RAM stores system configuration data and has an onboard battery power supply. To reset the CMOS settings, set the jumper on pins 2 and 3 while the system is off. Return the jumper to pins 1 and 2 afterwards. Setting the jumper while the system is on will damage the board. The default setting is "Short" pins 1 and 2.

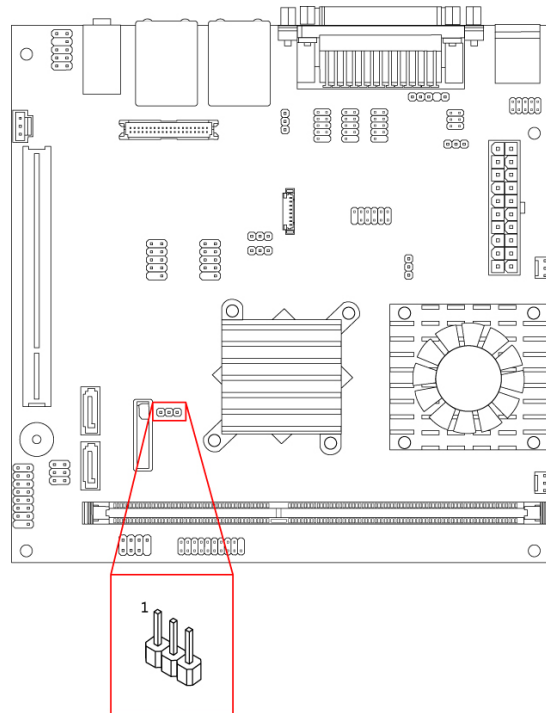

Figure 31: Clear CMOS jumper diagram

Setting	Pin 1	Pin 2	Pin 3
Regular (default)	Short	Short	Open
Clear CMOS	Open	Short	Short

Table 27: Clear CMOS jumper settings



Note:

Except when clearing the RTC RAM, never remove the cap from the Clear CMOS jumper default position. Removing the cap will cause system boot failure. Avoid clearing the CMOS while the system is on; it will damage the board.

3.2. COM Voltage Jumpers

Each of the additional COM ports (available through the onboard COM pin headers, see page 20) can support both +5V and +12V. COM2 has its own pin header block. COM3 and COM4 share a single pin header block. COM5 and COM6 also share a single pin header block.

3.2.1. COM2 Voltage Jumper

The voltage for COM2 is controlled by the jumper labeled as "J12". The voltage can be either +5V or +12V. +5V is the default setting. The jumper settings are shown below.

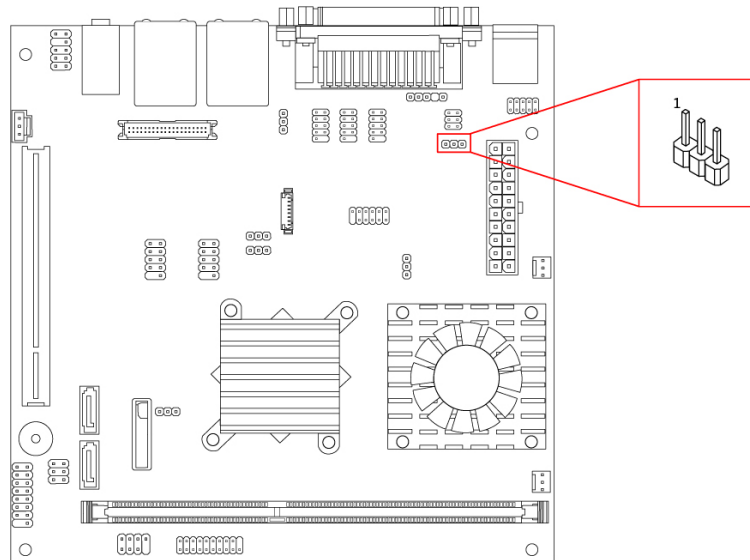

Figure 32: COM2 voltage jumper diagram

Settings	Pin 1	Pin 2	Pin 3
+5V (default)	Short	Short	Open
+12V	Open	Short	Short

Table 28: COM2 voltage jumper settings

3.2.2. COM3 and COM4 Voltage Jumper

The voltage for COM3 and COM4 is controlled by the jumper labeled as "J13". The voltage can be either +5V or +12V. +5V is the default setting. The even pin numbers correspond to COM3. The odd pin numbers correspond to COM4. The jumper settings are shown below.

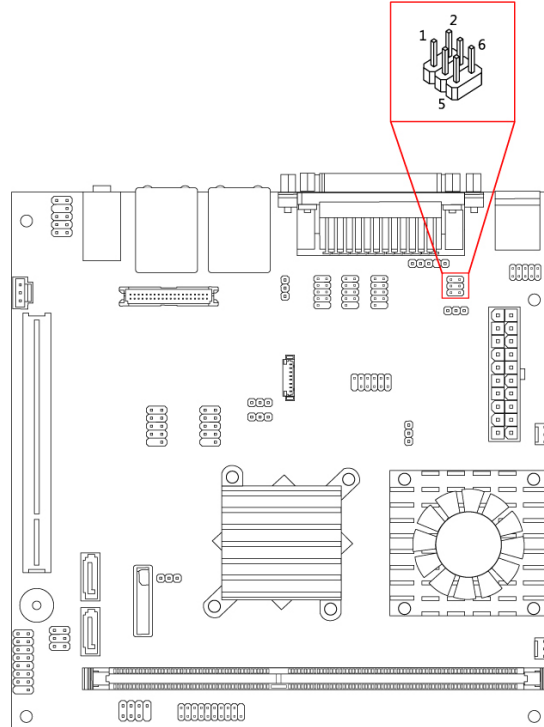

Figure 33: COM3 and COM4 voltage jumper diagram

COM4 Settings	Pin 1	Pin 3	Pin 5
+5V (default)	Short	Short	Open
+12V	Open	Short	Short

COM3 Settings	Pin 2	Pin 4	Pin 6
+5V (default)	Short	Short	Open
+12V	Open	Short	Short

Table 29: COM3 and COM4 voltage jumper settings

3.2.3. COM5 and COM6 Voltage Jumper

The voltage for COM5 and COM6 is controlled by the jumper labeled as "J14". The voltage can be either +5V or +12V. +5V is the default setting. The even pin numbers correspond to COM5. The odd pin numbers correspond to COM6. The jumper settings are shown below.

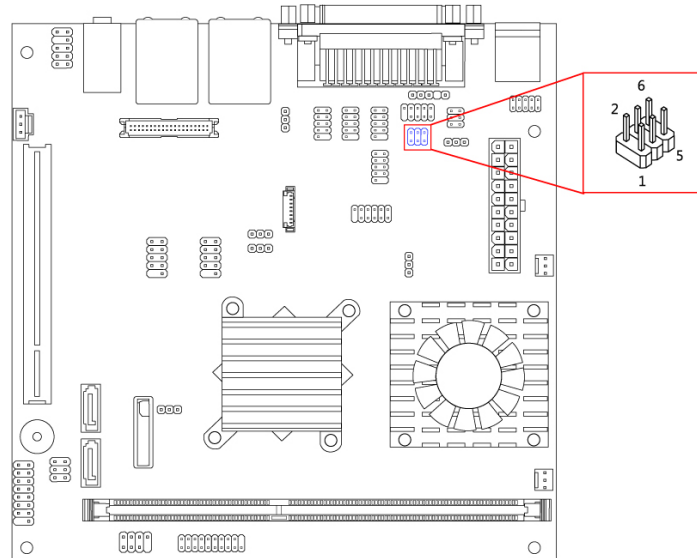

Figure 34: COM5 and COM6 voltage jumper diagram

COM6 Setting	Pin 1	Pin 3	Pin 5
+5V (default)	Short	Short	Open
+12V	Open	Short	Short

COM5 Setting	Pin 2	Pin 4	Pin 6
+5V (default)	Short	Short	Open
+12V	Open	Short	Short

Table 30: COM5 and COM6 voltage jumper settings



Note:

If the board is not equipped with COM5 and COM6, then the J14 jumper will not be on the board either.

3.3. SATA DOM Power Jumper

The SATA connectors (see page 18) can be used to support Disk-on-Module (DOM) flash drives. The power for SATA DOM is controlled by the jumper labeled as "J2". When the jumpers are set, +5V will be delivered to the 7th pin of the SATA connectors. The jumper settings are shown below.

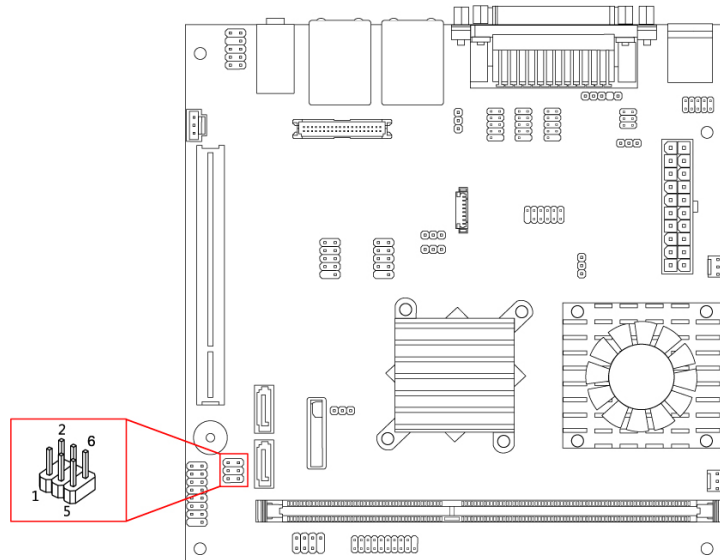

Figure 35: SATA DOM power jumper diagram

SATA1 Settings	Pin 1	Pin 3	Pin 5
DOM support	Short	Short	Open
Regular (default)	Open	Short	Short

SATA2 Settings	Pin 2	Pin 4	Pin 6
DOM support	Short	Short	Open
Regular (default)	Open	Short	Short

Table 31: SATA DOM power jumper settings



Note:

The default settings of "SATA DOM Power Jumper": short pin 3&5 and pin 4&6

3.4. LVDS Panel Power Jumper

The VIA VB7009 has a jumper that controls the voltage delivered to the LVDS panel connector. The jumper is labeled as "PVDD1". The jumper settings are shown below.

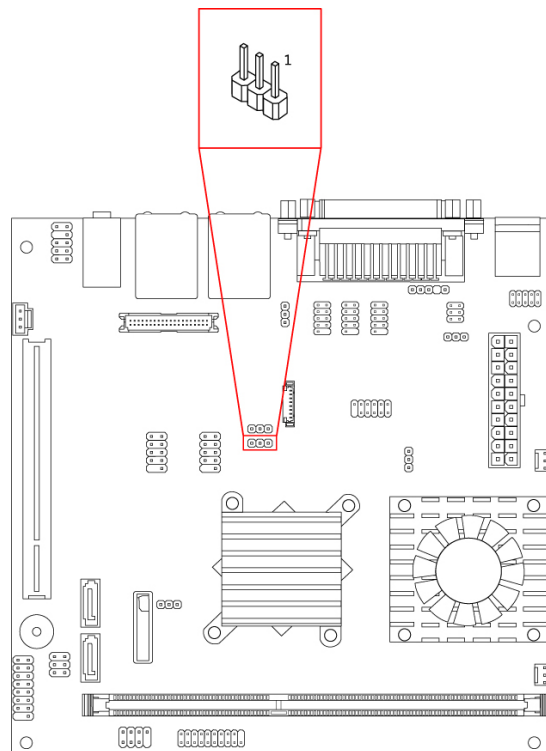

Figure 36: LVDS panel power jumper diagram

LVDS panel power settings	Pin 1	Pin 2	Pin 3
+5V	Short	Short	Open
+3.3V (default)	Open	Short	Short

Table 32: LVDS panel power jumper settings

3.5. LVDS Inverter Power Jumper

The VIA VB7009 has a jumper that controls the input voltage delivered to the LVDS inverter connector. The jumper is labeled as "IVDD_SEL1". The jumper settings are shown below.

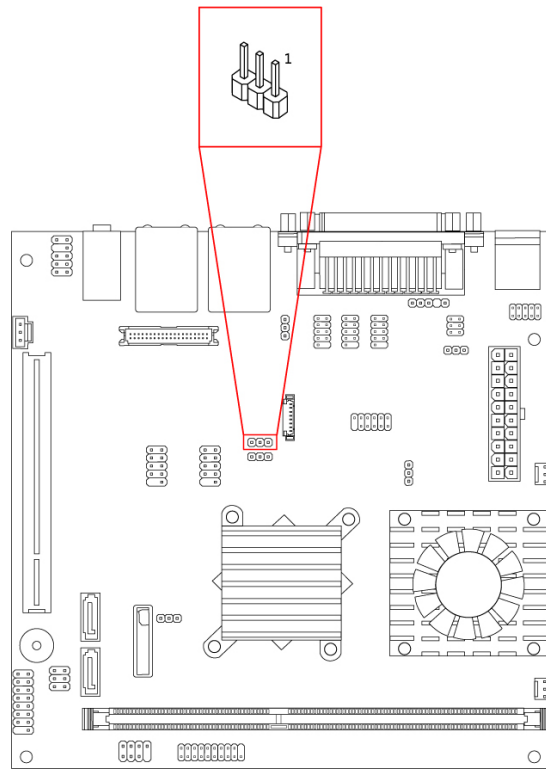

Figure 37: LVDS inverter power jumper diagram

LVDS inverter power settings	Pin 1	Pin 2	Pin 3
+5V	Short	Short	Open
+12V (default)	Open	Short	Short

Table 33: LVDS inverter power jumper settings

4. Expansion Slots

4.1. DDR3 Memory Slots

The VIA VB7009 provides one DDR3 DIMM memory slot. The memory slot can accommodate up to 4GB of 1066MHz memory. The memory slot is labeled as "DIMM1". The location of the DDR3 memory slot is shown below.

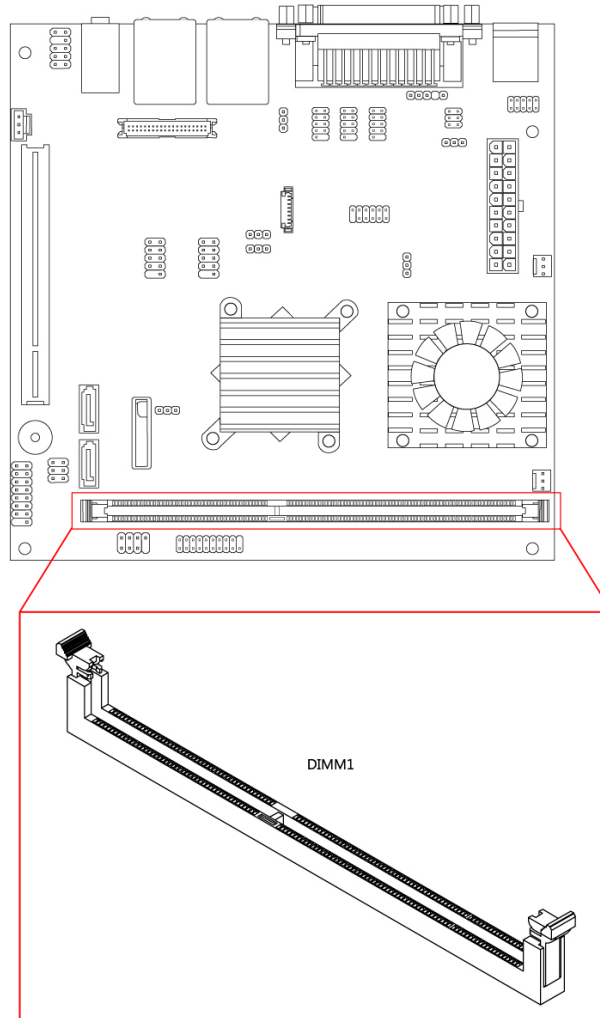

Figure 38: DDR3 memory slot diagram

4.1.1. Installing a Memory Module

Step 1

Disengage the locking mechanism at both ends of the DIMM slot by pressing the retaining clips outward.



Figure 39: Unlocking the memory DIMM slot

Step 2

Align the notch on the DIMM memory module with the counterpart on the DIMM slot.

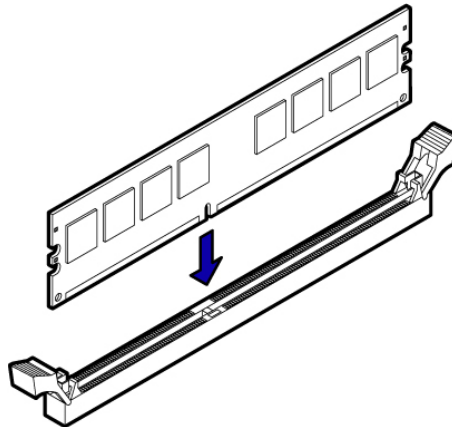

Figure 40: Inserting the memory module

Step 3

Insert the DIMM memory module into the slot and push down at both ends until the locking clips lock the DIMM memory module into place.

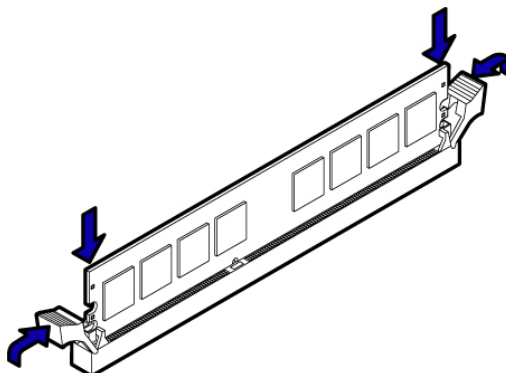

Figure 41: Locking the memory module

4.1.2. Removing a Memory Module

Step 1

To disengage the locking clips, push outward the locking clips on both ends of memory slot. When the locking clips have cleared, the DIMM memory module will automatically pop up. Remove the memory module.

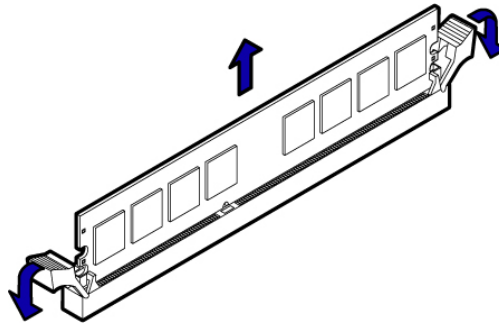

Figure 42: Removing the memory module

4.2. PCI Slot

The onboard PCI slot, labeled as "PCI_SLOT1", supports 5V 32-bit PCI cards. It is not compatible with PCI cards requiring 3.3V signaling. The location of the PCI slot is shown below.

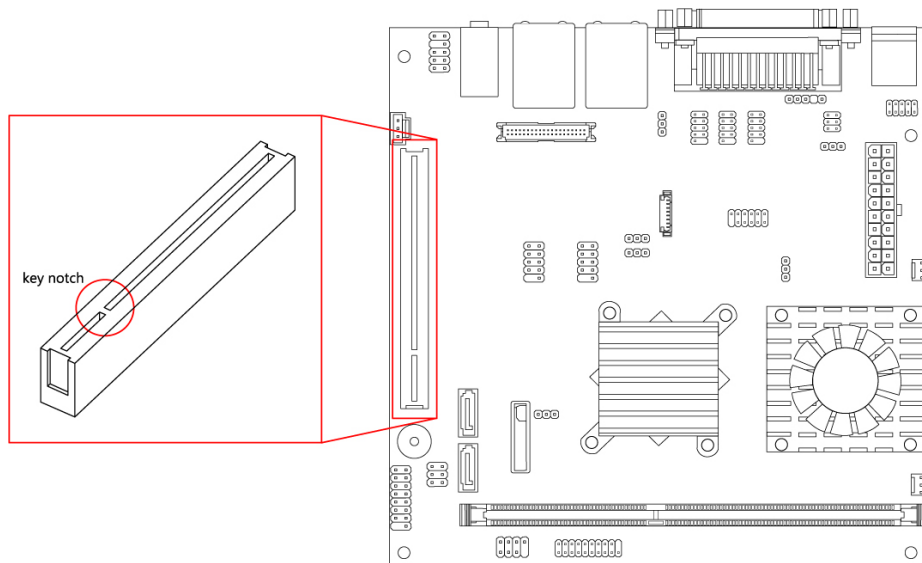

Figure 43: PCI slot diagram



Notes:

1. The orientation of PCI card can be changed from vertical to horizontal using a riser card.
2. When adding or removing expansion card, unplug first the power supply.

5. Installing into a Chassis

The VIA VB7009 can be fitted into any chassis that has the mounting holes for compatible with the standard Mini-ITX mounting hole locations. Additionally, the chassis must meet the minimum height requirements for specified areas of the board. If a riser card is being used, the chassis will need to accommodate the additional space requirements.

5.1.1. Suggested Minimum Chassis Dimensions

The figure below shows the suggested minimum space requirements that a chassis should have in order to work well with the VIA VB7009.

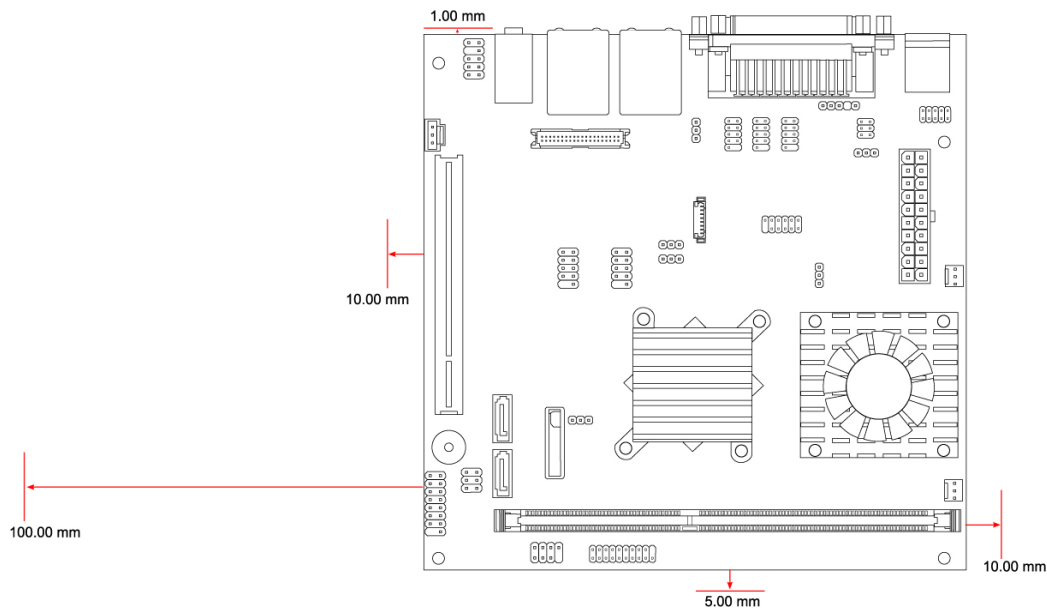

Figure 44: Suggested minimum chassis dimensions

Each side of the board should have a buffer zone from the internal wall of the chassis. The side of the board that accommodates the I/O coastline should have a buffer of 1mm. The side on the opposite end of the I/O coastline should have a buffer of at least 5mm. The two sides adjacent to the I/O coastline should have at least a 10mm buffer.

For the side that is close to the PCI slot, the buffer should be at least 100mm if a riser card will be used.

5.1.2. Suggested Minimum Chassis Height

The figure below shows the suggested minimum height requirements for the internal space of the chassis. It is not necessary for the internal ceiling to be evenly flat. What is required is that the internal ceiling height must be strictly observed for each section that is highlighted. The highest part of the ceiling will be above the PCI slot.

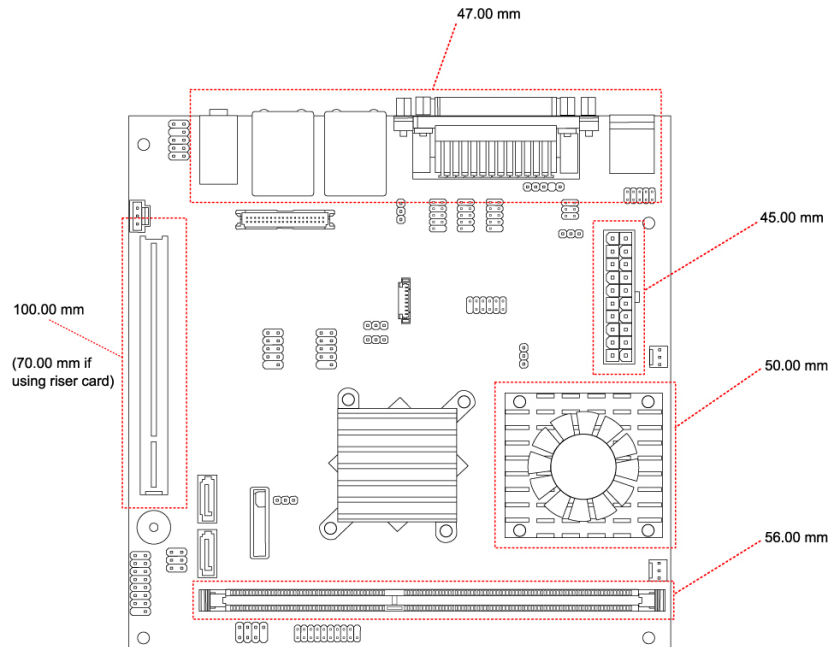

Figure 45: Suggested minimum internal chassis ceiling height

5.1.3. Suggested Keepout Areas

The figure below shows the areas of the board that we recommend should be left unobstructed.

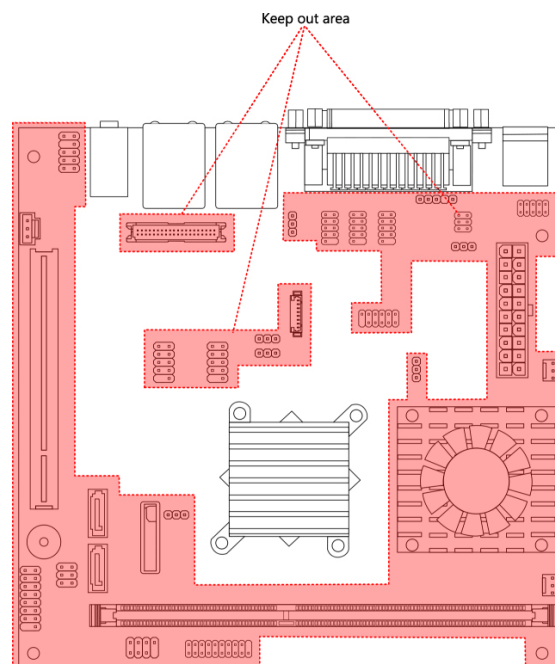

Figure 46: Suggested keepout areas

6. BIOS Setup Utility

6.1. Entering the BIOS Setup Utility

Power on the computer and press **Delete** during the beginning of the boot sequence to enter the BIOS Setup Utility. If the entry point has passed, restart the system and try again.

6.2. Control Keys

Up	Move up one row
Down	Move down one row
Left	Move to the left in the navigation bar
Right	Move to the right in the navigation bar
Enter	Access the highlighted item / Select the item
Esc	Jumps to the Exit screen or returns to the previous screen
Page up / +¹	Increase the numeric value
Page down / -¹	Decrease the numeric value
F1	General help ²
F5	Restore the previous CMOS value
F7	Load optimized defaults
F10	Save all the changes and exit



Notes:

1. Must be pressed using the 10-key pad.
2. The General help contents are only for the Status Page and Option Page setup menus.

6.3. Navigating the BIOS Menus

The main menu displays all the BIOS setup categories. Use the <Left>/<Right> and <Up>/<Down> arrow keys to select any item or sub-menu. Descriptions of the selected/highlighted category are displayed at the bottom of the screen.

The small triangular arrowhead symbol next to a field indicates that a sub-menu is available (see figure below). Press <Enter> to display the sub-menu. To exit the sub-menu, press <Esc>.

6.4. Getting Help

The BIOS Setup Utility provides a “**General Help**” screen. This screen can be accessed at any time by pressing **F1**. The help screen displays the keys for using and navigating the BIOS Setup Utility. Press **Esc** to exit the help screen.

6.5. Main Menu (BIOS for VB7009-16 / VB7009-10E SKU)

The Main Menu contains thirteen setup functions and two exit choices. Use arrow keys to select the items and press <Enter> to accept or enter Sub-menu.

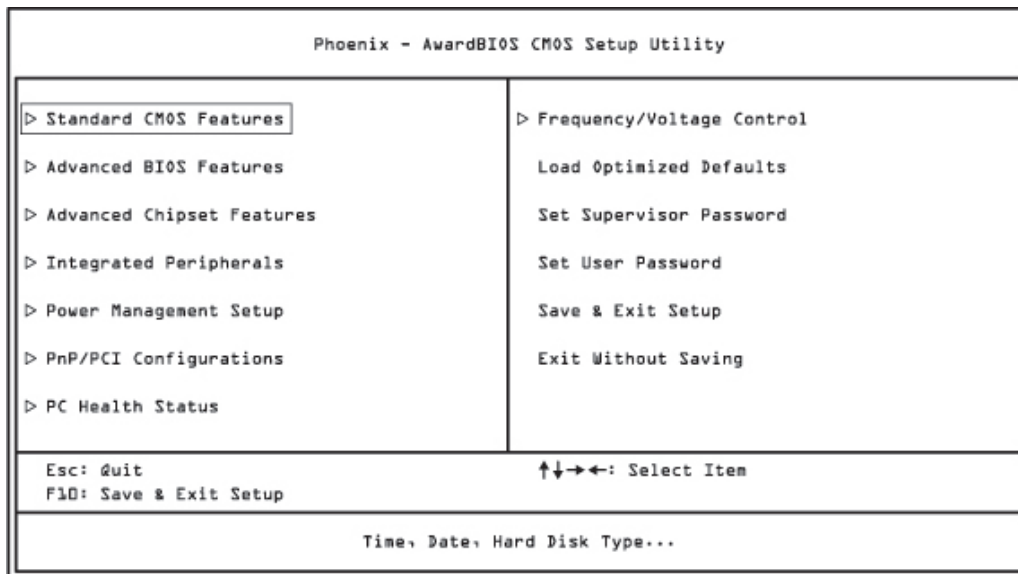

Figure 47: Illustration of the Main menu screen (for VB7009-16/VB7009-10E SKU)

6.5.1. Standard CMOS Features

Use this menu to set basic system configurations.

6.5.2. Advanced BIOS Features

Use this menu to set the advanced features available on your system.

6.5.3. Advanced Chipset Features

Use this menu to set chipset specific features and optimize system performance.

6.5.4. Integrated Peripherals

Use this menu to set onboard peripherals features.

6.5.5. Power Management Setup

Use this menu to set onboard power management functions.

6.5.6. PnP/PCI Configurations

Use this menu to set the PnP and PCI configurations.

6.5.7. PC Health Status

This menu shows the PC health status.

6.5.8. Frequency/Voltage Control

Use this menu to set the system frequency and voltage control.

6.5.9. Load Optimized Defaults

Use this menu option to load BIOS default settings for optimal and high performance system operations.

6.5.10. Set Supervisor Password

Use this menu option to set the BIOS supervisor password.

6.5.11. Set User Password

Use this menu option to set the BIOS user password.

6.5.12. Save & Exit Setup

Save BIOS setting changes and exit setup.

6.5.13. Exit Without Saving

Discard all BIOS setting changes and exit setup

6.6. Standard CMOS Features

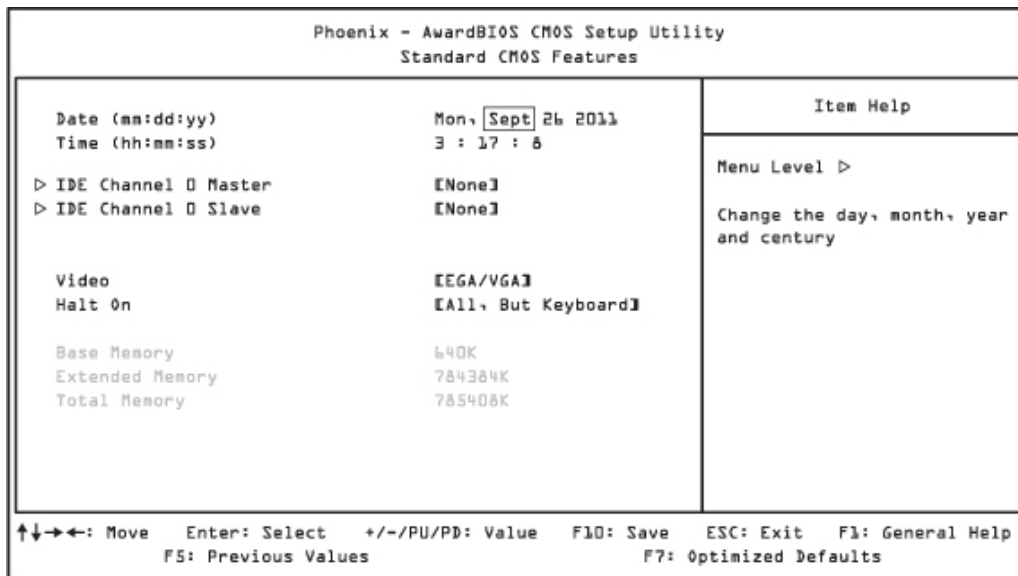

Figure 48: Illustration of the Standard CMOS Features screen

6.6.1. Date

The date format is [Day, Month Date, Year]

6.6.2. Time

The time format is [Hour : Minute : Second]

6.6.3. Video

Settings: [EGA/VGA, CGA 40, CGA 80, MONO]

6.6.4. Halt On

Set the system's response to specific boot errors. Below is a table that details the possible settings.

Settings	Description
All Errors	System halts when any error is detected
No Errors	System does not halt for any error
All, But Keyboard	System halts for all non-key errors

6.7. IDE Channels

Channel 0 Master

Phoenix - AwardBIOS CMOS Setup Utility		Item Help
IDE Channel 0 Master		
IDE HDD Auto-Detection	[Press Enter]	Menu Level ▷ To auto-detect the HDD's size, head... on this channel
IDE Channel 0 Master Access Mode	[Auto]	
Capacity	0 MB	
Cylinder	0	
Head	0	
Precomp	0	
Landing Zone	0	
Sector	0	
↑↓→←: Move Enter: Select +/-/PU/PD: Value F10: Save ESC: Exit F1: General Help F5: Previous Values F7: Optimized Defaults		

Figure 49: Illustration of the IDE Channel 0 Master screen

Channel 0 Slave

Phoenix - AwardBIOS CMOS Setup Utility		Item Help
IDE Channel 0 Slave		
IDE HDD Auto-Detection	[Press Enter]	Menu Level ▷ To auto-detect the HDD's size, head... on this channel
IDE Channel 0 Slave Access Mode	[Auto]	
Capacity	0 MB	
Cylinder	0	
Head	0	
Precomp	0	
Landing Zone	0	
Sector	0	
↑↓→←: Move Enter: Select +/-/PU/PD: Value F10: Save ESC: Exit F1: General Help F5: Previous Values F7: Optimized Defaults		

Figure 50: Illustration of the IDE Channel 0 Slave screen



The specifications of your drive must match with the drive table. The hard disk will not work properly if you enter incorrect information in this category. Select **"Auto"** whenever possible. If you select **"Manual"**, make sure the information is from your hard disk vendor or system manufacturer.

Below is a table that details required hard drive information when using the **"Manual"** mode.

Settings	Description
[storage] Channel	The name of this match the name of the menu. Settings: [None, Auto, Manual]
Access Mode	Settings: [CHS, LBA, Large, Auto]
Capacity	Formatted size of the storage device
Cylinder	Number of cylinders
Head	Number of heads
Precomp	Write precompensation
Landing Zone	Cylinder location of the landing zone
Sector	Number of sectors

6.8. Advanced BIOS Features

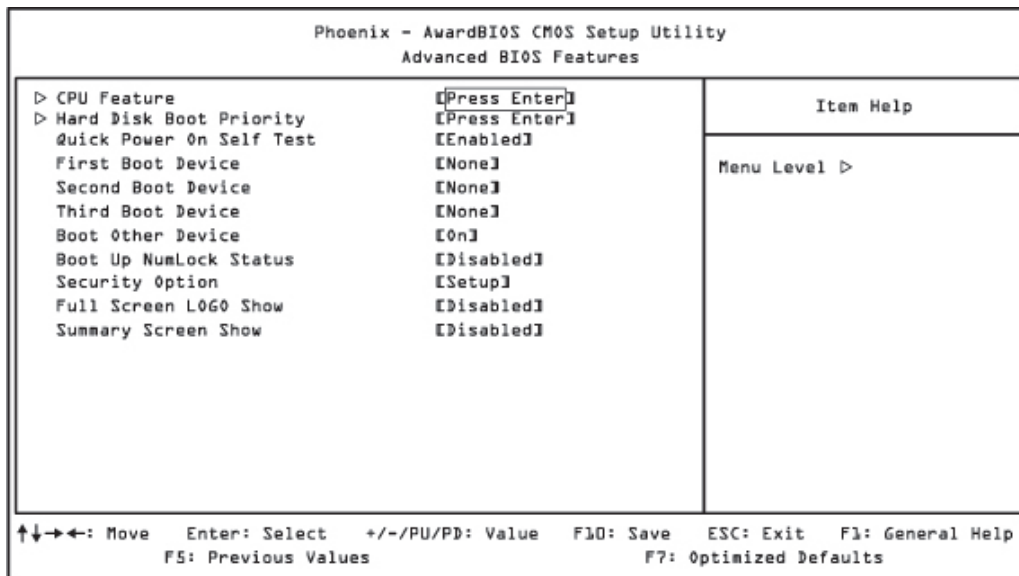

Figure 51: Illustration of the Advanced BIOS Features screen

The Advanced BIOS Features section includes the following submenus:

- CPU Feature
- Hard Disk Boot Priority

6.8.1. Quick Power On Self-Test

Shortens Power On Self-Test (POST) cycle to enable shorter boot up time.

Settings	Description
Disabled	Standard Power On Self Test (POST)
Enabled	Shorten Power On Self Test (POST) cycle and boot up time

6.8.2. First/Second/Third Boot Device

Set the boot device sequence as BIOS attempts to load the disk operating system.

Settings	Description
Removable	Boot from external drive
Hard Disk	Boot from the HDD
CDROM	Boot from CDROM
Legacy LAN	Boot from network drive
VIA Networking	Boot from network drive
Disabled	Disable the boot device sequence

6.8.3. Boot Other Device

Enables the system to boot from alternate devices if the system fails to boot from the "First/Second/Third Boot Device" lists.

Settings	Description
Disabled	No alternate boot device allowed
Enabled	Enable alternate boot device

6.8.4. Boot Up NumLock Status

Set the NumLock status when the system is powered on.

Settings	Description
Off	Forces keypad to behave as arrow keys
On	Forces keypad to behave as 10-key

6.8.5. Security Option

Selects whether the password is required every time the System boots, or only when you enter Setup.

Settings	Description
Setup	Password prompt appears only when end users try to run BIOS Setup
System	Password prompt appears every time when the computer is powered on and when end users try to run BIOS Setup

6.8.6. Full Screen Logo Show

Show full screen logo during BIOS boot up process.

Settings: [Disabled, Enabled]

6.8.7. Summary Screen Show

Show summary screen.

Settings: [Disabled, Enabled]

6.9. CPU Feature

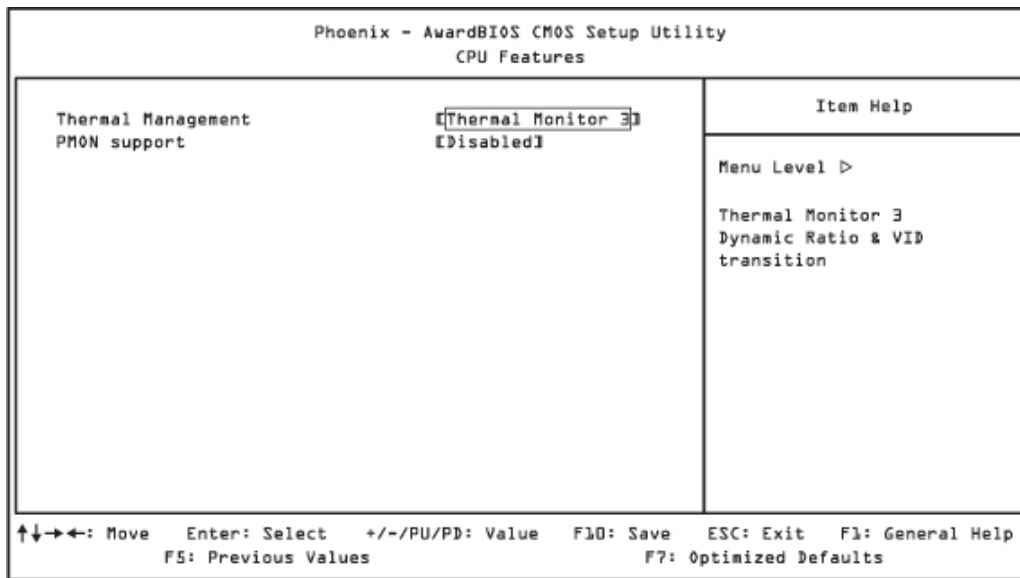

Figure 52: Illustration of the CPU Feature screen

6.9.1. Thermal Management

This item sets CPU's thermal control rule to protect CPU from overheating.

Settings	Description
Thermal Monitor 3	Dynamic Ratio & VID Transition
Disabled	Disable this feature

6.9.2. PMON support

This feature controlled the CPU speed to perform automatically at best performance to comply with the given system applications.

Settings	Description
Disabled	Turn off this feature.
Auto	Automatically control the CPU speed to perform at best performance.

6.10. Hard Disk Boot Priority

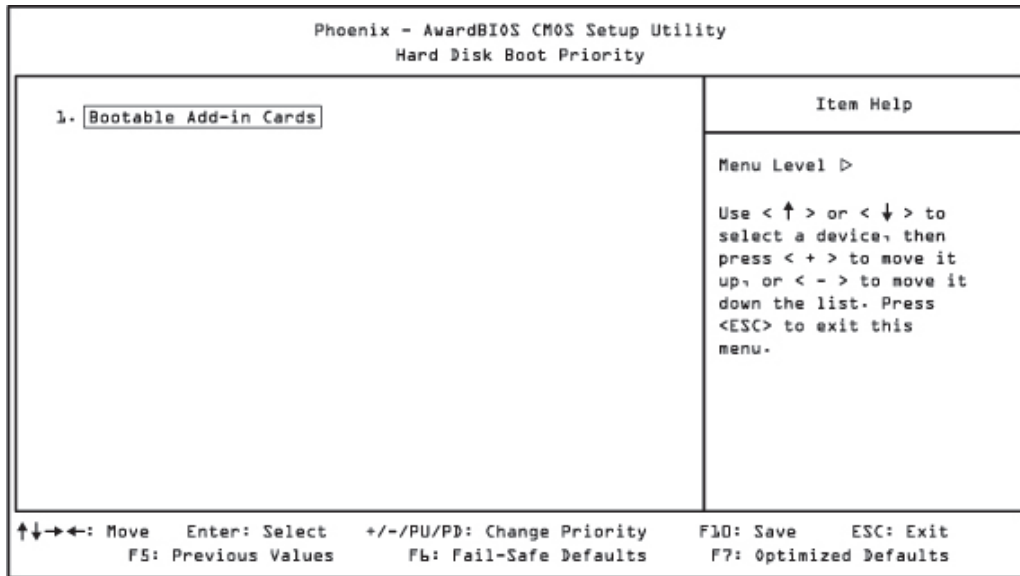

Figure 53: Illustration of the Hard Disk Boot Priority screen

This is for setting the priority of the hard disk boot order when the "Hard Disk" option is selected in the "[First/Second/Third] Boot Device" menu item.

6.11. Advanced Chipset Features

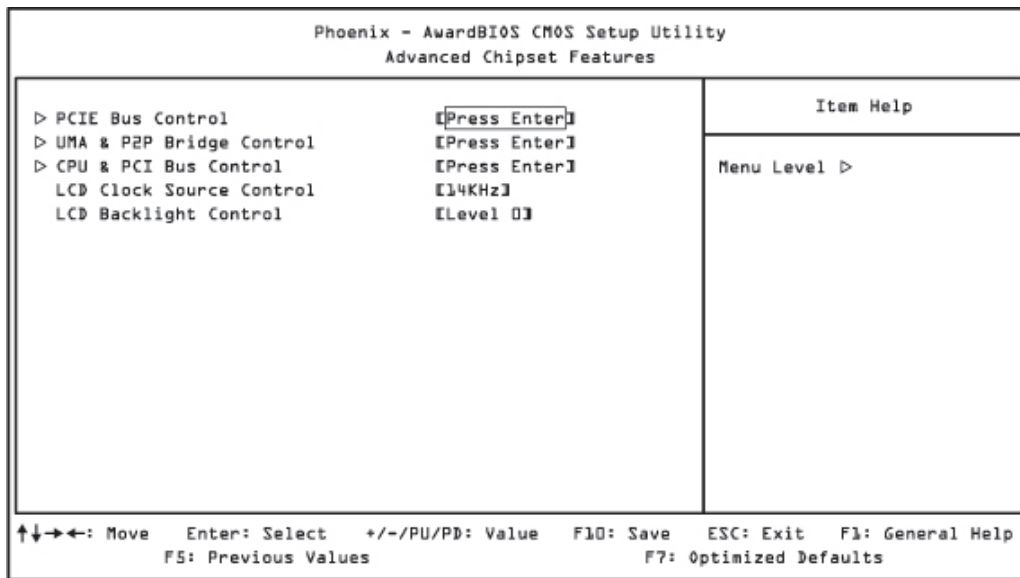

Figure 54: Illustration of the Advanced Chipset Features screen



Caution:

The Advanced Chipset Features menu is used for optimizing the chipset functions. Do not change these settings unless you are familiar with the chipset.

The Advanced Chipset Features section includes the following submenus:

- PCIE Bus Control
- UMA & P2P Bridge Control
- CPU & PCI Bus Control

6.11.1. LCD Clock Source Control

Settings: [14KHz, 7KHz, 110Hz, 55Hz]

6.11.2. LCD Backlight Control

Settings: [Level 0, Level 1, Level 2, Level 3, Level 4, Level 5, Level 6, Level 7, Level 8]

6.12. PCIE Bus Control

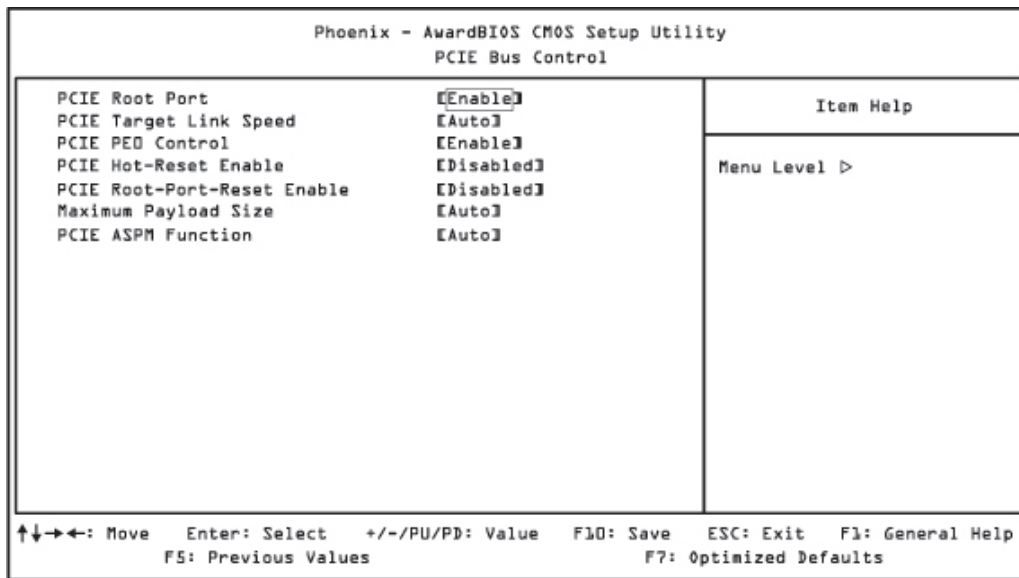

Figure 55: Illustration of the PCIE Bus Control screen

6.12.1. PCIE Root Port

Settings: [Disabled, Enabled]

6.12.2. PCIE Target Link Speed

Settings: [Auto, Force Gen1]

6.12.3. PCIE PE0 Control

Settings: [Disabled, Enabled]

6.12.4. PCIE Hot-Reset Enable

Settings: [Disabled, Enabled]

6.12.5. PCIE Root-Port-Reset Enable

Settings: [Disabled, Enabled]

6.12.6. Maximum Payload Size

Settings: [Auto, 128 Byte]

6.12.7. PCIE ASPM Function

Settings: [Force Disable, Auto]

6.13. UMA & P2P Bridge Control

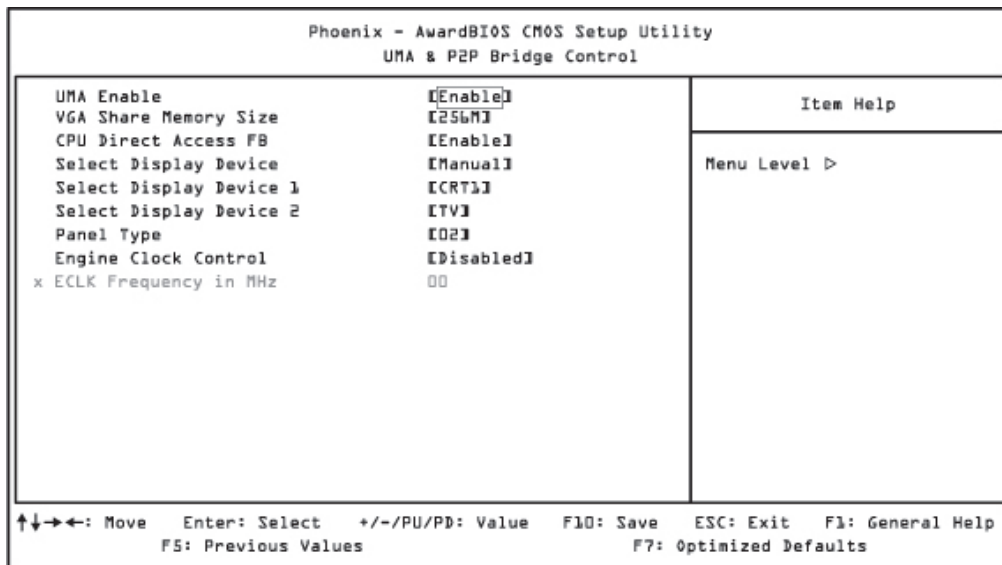

Figure 56: Illustration of the UMA & P2P Bridge Control screen

6.13.1. UMA Enable

Settings: [Disabled, Enabled]

6.13.2. VGA Share Memory Size

This setting allows you to select the amount of system memory that is allocated to the integrated graphics processor.

Settings: [64M, 128M, 256M]

6.13.3. CPU Direct Access FB

Settings: [Disabled, Enabled]

6.13.4. Select Display Device

This setting refers to the type of display being used with the system.

Settings: [Auto, Manual]

6.13.5. Select Display Device 1

This setting refers to the type of display device 1 being used with the system.

Settings: [CRT, LCD]

6.13.6. Select Display Device 2

This setting refers to the type of display device 2 being used with the system.

Settings: [CRT, LCD]

6.13.7. Panel Type

Key in a HEX number.

Settings: [Min = 0000, Max = 0000F]

6.13.8. Engine Clock Control

Settings: [Disabled, Enabled]

6.14. CPU & PCI Bus Control

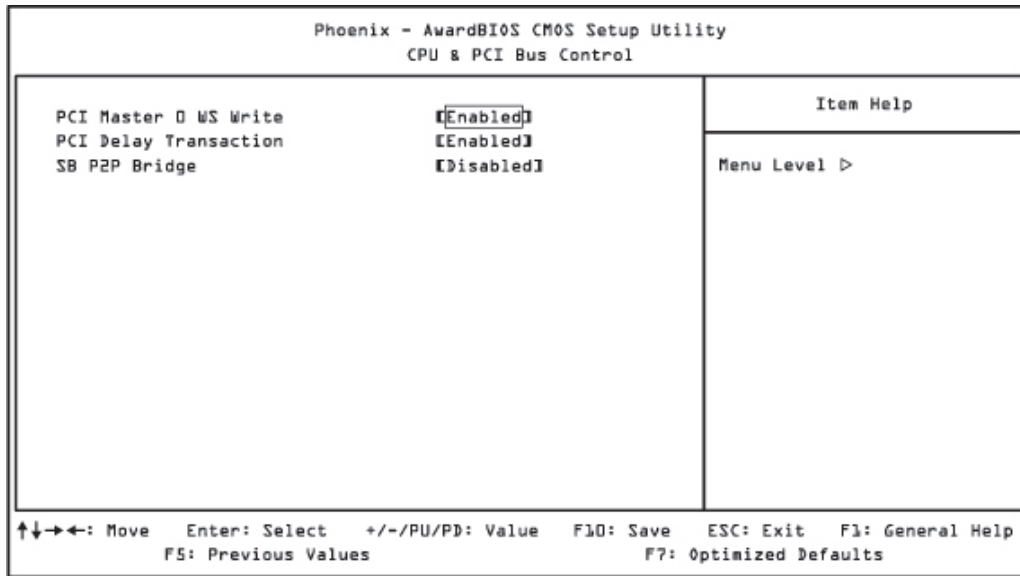

Figure 57: Illustration of the CPU & PCI Bus Control screen

6.14.1. PCI Master 0 WS Write

Settings: [Enabled, Disabled]

6.14.2. PCI Delay Transaction

Settings: [Disabled, Enabled]

6.14.3. SB P2P Bridge

Settings: [Disabled, Enabled]

6.15. Integrated Peripherals

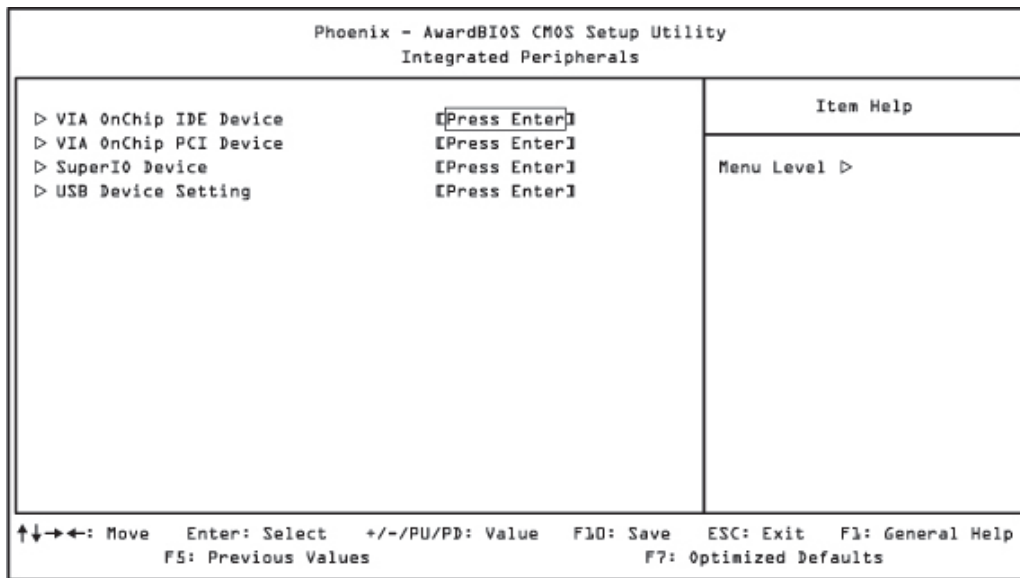

Figure 58: Illustration of the Integrated Peripherals screen

The Integrated Peripherals section includes the following submenus:

- VIA OnChip IDE Device
- VIA OnChip PCI Device
- SuperIO Device
- USB Device Setting

6.16. VIA OnChip IDE Device

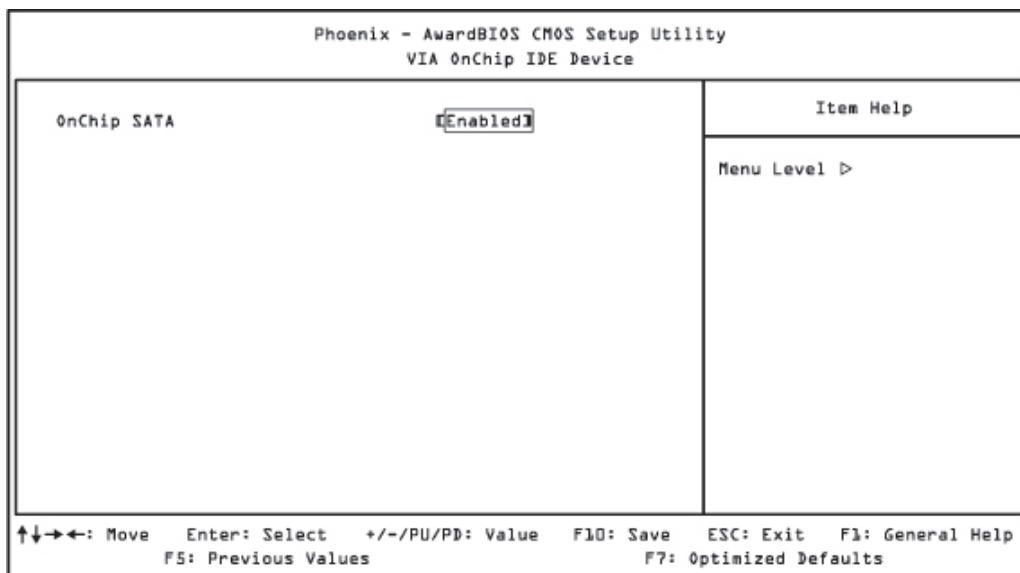

Figure 59: Illustration of the VIA OnChip IDE Device screen

6.16.1. OnChip SATA

Settings: [Disabled, Enabled]

6.17. VIA OnChip PCI Device

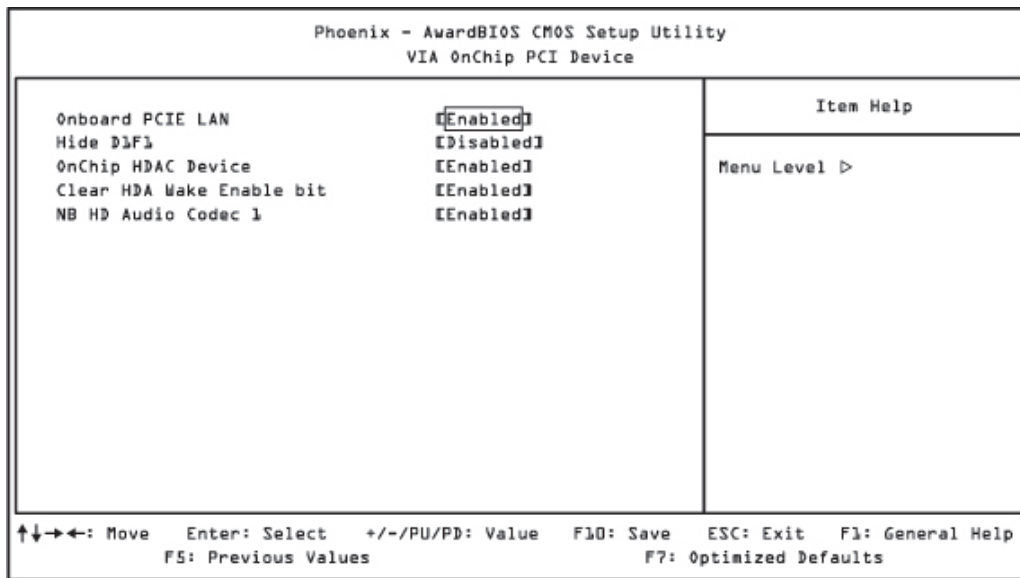

Figure 60: Illustration of the VIA OnChip PCI Device screen

6.17.1. Onboard PCIE LAN

Settings: [Enabled, Disabled]

6.17.2. Hide D1F1

Settings: [Enabled, Disabled]

6.17.3. OnChip HDAC Device

Settings: [Enabled, Disabled]

6.17.4. Clear HDA Wake Enable bit

Settings: [Enabled, Disabled]

6.17.5. NB HD Audio Codec 1

Settings: [Enabled, Disabled]

6.18. SuperIO Device

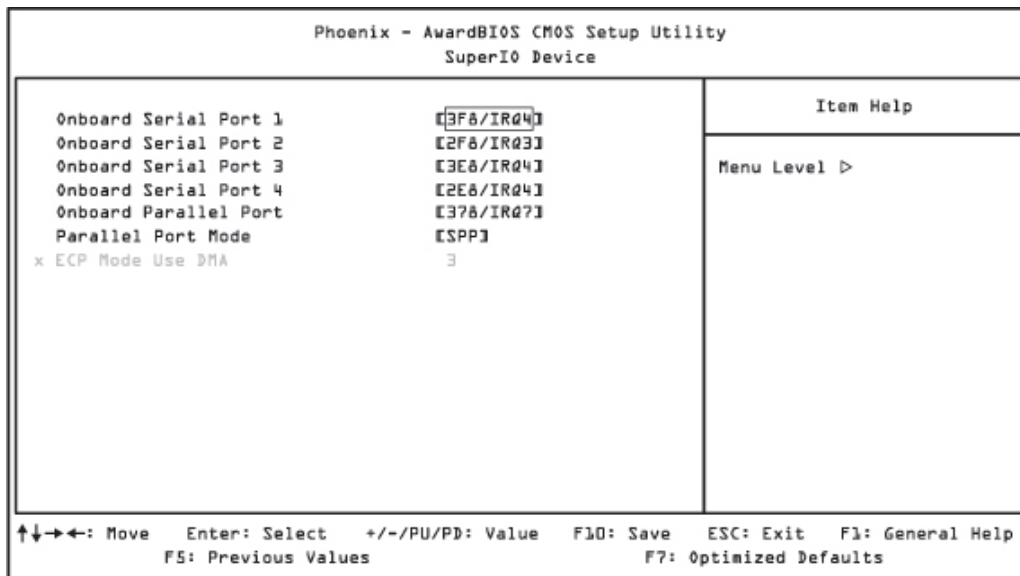

Figure 61: Illustration of the SuperIO Device screen

6.18.1. Onboard Serial Ports 1 ~ 4

Set the base I/O port address and IRQ for the onboard serial ports. Selecting “Auto” allows the BIOS to automatically determine the correct base I/O port.

Port	Address	IRQ
1	Disabled, 3F8, 2F8, 3E8, 2E8, 338, 348, Auto	4
2	Disabled, 3F8, 2F8, 3E8, 2E8, 338, 348, Auto	4
3	Disabled, 3F8, 2F8, 3E8, 2E8, 338, 348, Auto	4
4	Disabled, 3F8, 2F8, 3E8, 2E8, 338, 348, Auto	4

6.18.2. Onboard Parallel Port

This specifies the I/O port address and IRQ of the onboard parallel port.

Settings: [Disabled, 378/IRQ7, 278/IRQ5, 3BC/IRQ7]

6.18.3. Parallel Port Mode

Set the parallel port mode. To operate the onboard parallel port as Standard Parallel Port, choose SPP. To operate the onboard parallel port in the EPP mode, choose EPP. By choosing ECP, the onboard parallel port will operate in ECP mode. Choosing ECP + EPP will allow the onboard parallel port to support both the ECP and EPP modes simultaneously.

Settings: [SPP, EPP, ECP, ECP + EPP]

6.18.4. ECP Mode Use DMA

ECP (Extended Capabilities Port) has two DMA channels that it can use. The default channel is 3. However, some expansion cards may use channel 3 as well. To solve this conflict, change the ECP channel to 1. Select a DMA channel for the port.

Settings: [1, 3]

6.19. USB Device Setting

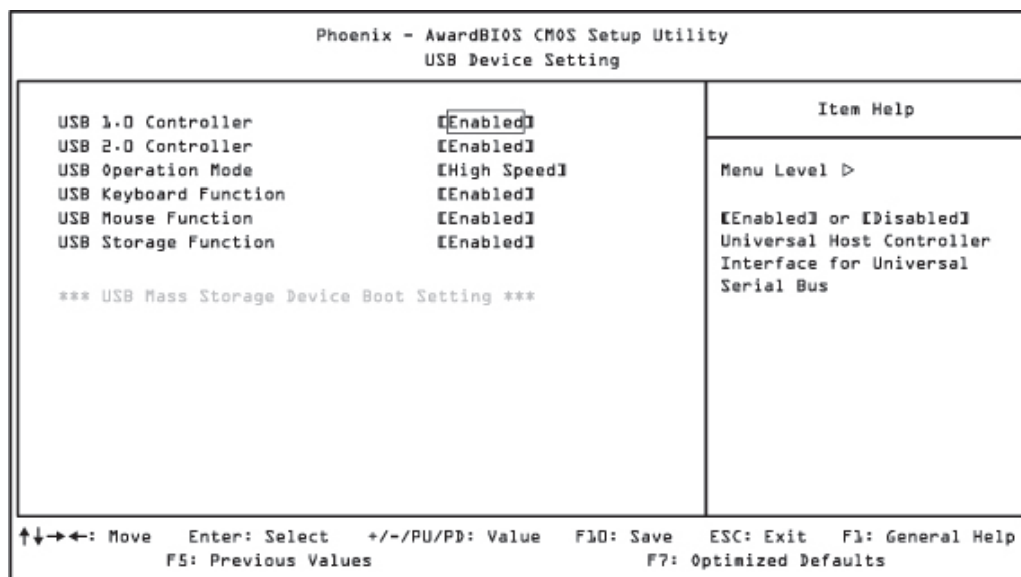

Figure 62: Illustration of the USB Device Setting screen

6.19.1. USB 1.0 Controller

Enable or disable Universal Host Controller Interface for Universal Serial Bus.

Settings: [Disabled, Enabled]

6.19.2. USB 2.0 Controller

Enable or disable Enhanced Host Controller Interface for Universal Serial Bus.

Settings: [Disabled, Enabled]

6.19.3. USB Operation Mode

Auto decide USB device operation mode.

Settings	Description
Full/Low Speed	All of USB Device operated on full/low speed mode
High Speed	If USB device was high speed device, then it operated on high speed mode.

6.19.4. USB Keyboard Function

Enable or disable legacy support of USB keyboard.

Settings: [Disabled, Enabled]

6.19.5. USB Mouse Function

Settings: [Disabled, Enabled]

6.19.6. USB Storage Function

Enable or disable legacy support of USB mass storage.

Settings: [Disabled, Enabled]

6.20. Power Management Setup

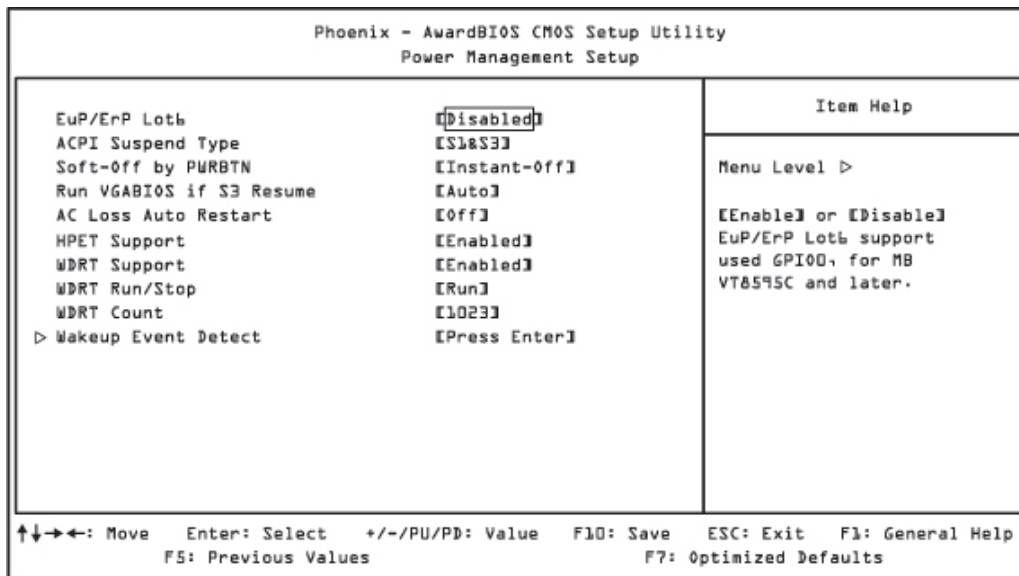

Figure 63: Illustration of the Power Management Setup screen

The Power Management Setup section includes the following submenus:

- Wakeup Event Detect

6.20.1. EuP/ErP Lot6

This feature determines whether to let the system consume less power ACPI S3/S4/S5 state.

Settings: [Disabled, Enabled]



Note:

When EuP/ErP Lot6 support is enabled, the Wake on LAN from system OS ACPI S3/S4/S5 state will be disabled.

6.20.2. ACPI Suspend Type

Settings	Description
S1(POS)	S1/Power On Suspend (POS) is a low power state. In this state, no system context (CPU or chipset) is lost and hardware maintains all system contexts.
S3(STR)	S3/Suspend To RAM (STR) is a power-down state. In this state, power is supplied only to essential components such as main memory and wakeup-capable devices. The system context is saved to main memory, and context is restored from the memory when a "wakeup" event occurs.
S1 & S3	Depends on the OS to select S1 or S3.

6.20.3. Soft-Off by PWRBTN

Settings	Description
Delay 4 Sec	System is turned off if power button is pressed for more than four seconds.
Instant-Off	Power button functions as a normal power-on/-off button.

6.20.4. Run VGABIOS if S3 Resume

Select whether to run VGA BIOS if resuming from S3 state. This is only necessary for older VGA drivers.

Settings: [Auto, Yes, No]

6.20.5. AC Loss Auto Restart

The field defines how the system will respond after an AC power loss during system operation.

Settings	Description
Off	Keeps the system in an off state until the power button is pressed
On	Restarts the system when the power is back
Former-Sts	Former-Sts

6.20.6. HPET Support

Settings: [Disabled, Enabled]

6.20.7. WDRT Support

Settings: [Disabled, Enabled]

6.20.8. WDRT Run/Stop

Settings: [Stop, Run]

6.20.9. WDRT Count

Key in a DEC number.

Settings: [Min = 0, Max = 1023]

6.21. Wakeup Event Detect

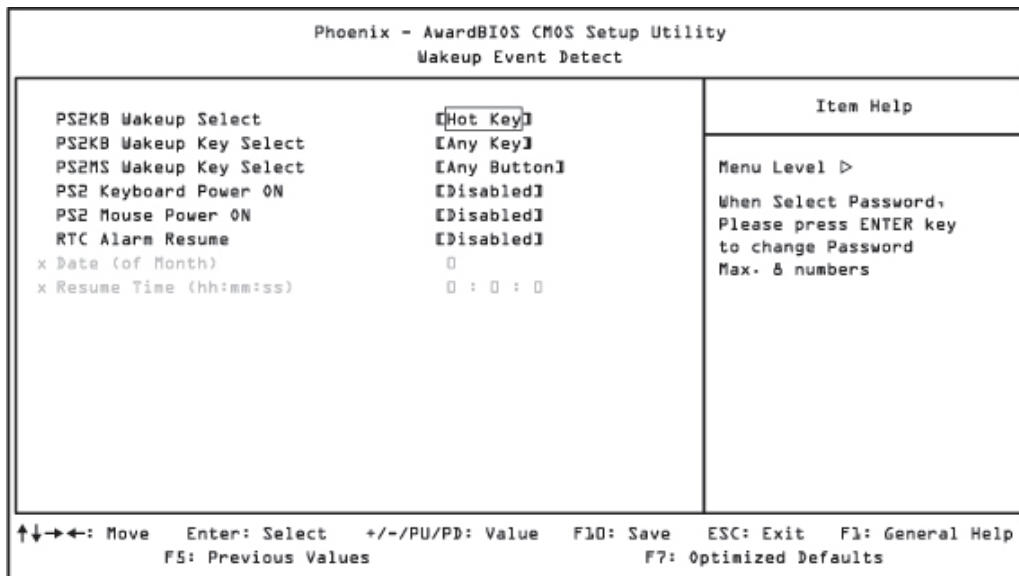

Figure 64: Illustration of the Wakeup Event Detect screen

6.21.1. PS2KB Wakeup Select

This feature has two settings: Hot Key and Password. To select the Password option, press <Page Up> or <Page Down>. To set the password, enter up to eight digits and press <Enter>.

Settings: [Hot Key]

6.21.2. PS2KB Wakeup Key Select

This feature is only available when "Hot Key" is chosen in "PS2KB Wakeup Select".

Settings: [Ctrl+F1, Ctrl+F2, Ctrl+F3, Ctrl+F4, Ctrl+F5, Ctrl+F6, Ctrl+F7, Ctrl+F8, Ctrl+F9, Ctrl+F10, Ctrl+F11, Ctrl+F12, Power, Wake, Any Key]

6.21.3. PS2MS Wakeup Key Select

Enables any mouse activity to restore the system from the power saving mode to an active state.

Settings: [Any Button, Left Button, Right Button]

6.21.4. PS2 Keyboard Power ON

Settings: [Disabled, Enabled]

6.21.5. PS2 Mouse Power ON

Settings: [Disabled, Enabled]

6.21.6. RTC Alarm Resume

Set a scheduled time and/or date to automatically power on the system.

Settings: [Disabled, Enabled]

6.21.7. Date (of Month)

This field can only be set if "RTC Alarm Resume" is enabled. The field specifies the date for "RTC Alarm Resume".

6.21.8. Resume Time (hh:mm:ss)

This field can only be set if "RTC Alarm Resume" is enabled. The field specifies the time for "RTC Alarm Resume".

6.22. PnP/PCI Configurations

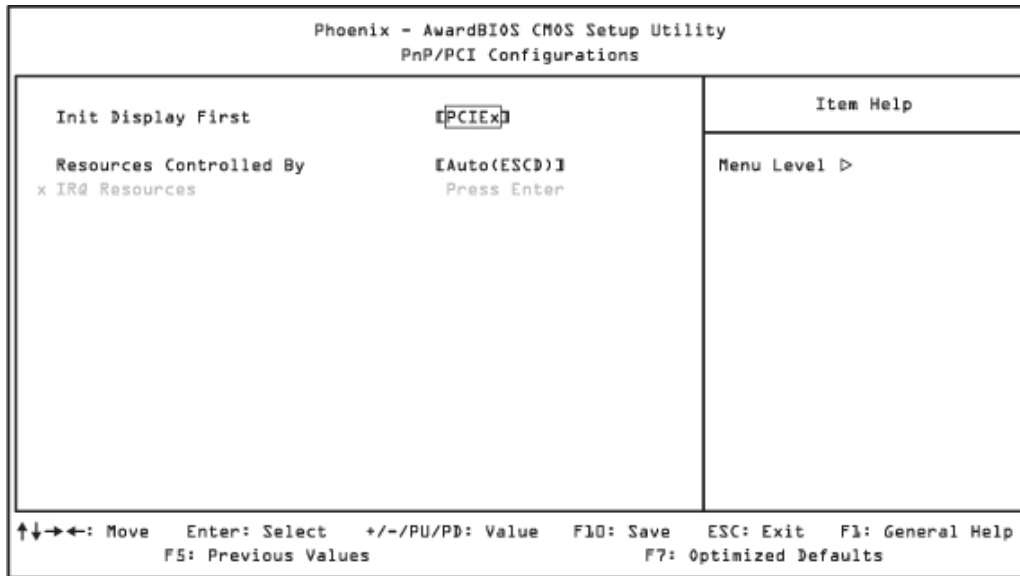

Figure 65: Illustration of the PnP/PCI Configurations screen



Note:

This section covers some very technical items and it is strongly recommended to leave the default settings as is unless you are an experienced user.

6.22.1. Init Display First

Settings: [PCI slot, Onboard, PCIEx]

6.22.2. Resources Controlled By

Enables the BIOS to automatically configure all the Plug-and-Play compatible devices.

Settings	Description
Auto(ESCD)	BIOS will automatically assign IRQ, DMA and memory base address fields
Manual	Unlocks "IRQ Resources" for manual configuration

6.24. Frequency/Voltage Control

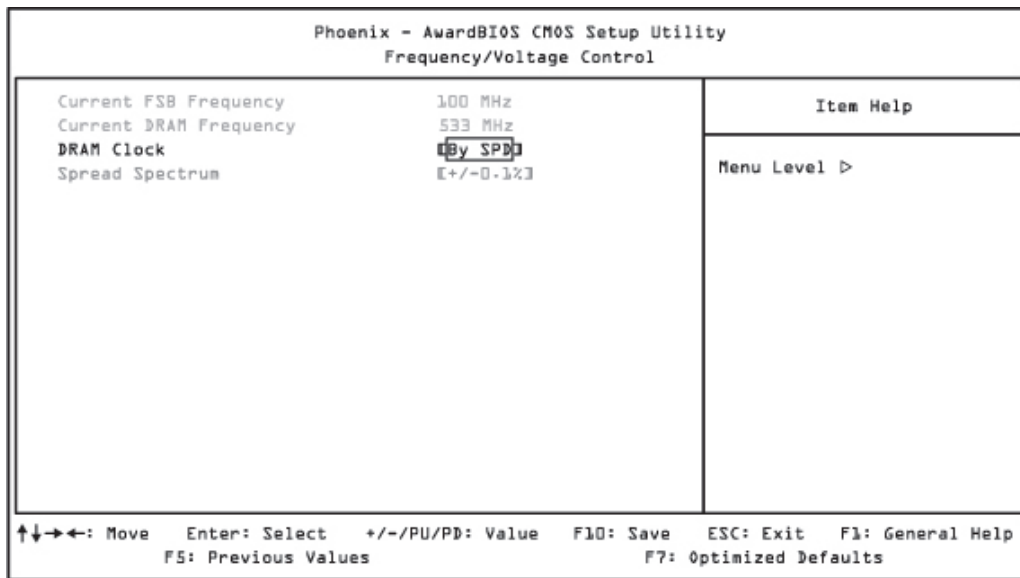

Figure 67: Illustration of the Frequency/Voltage Control screen

6.24.1. DRAM Clock

This chipset supports synchronous and asynchronous mode between host clock and DRAM clock frequency.

Settings: [By SPD, 400MHz, 533MHz]

6.24.2. Spread Spectrum

When the board's clock generator pulses, the extreme values (spikes) of the pulses create EMI (Electromagnetic Interference). The Spread Spectrum function reduces the EMI generated by modulating the pulses so that the spikes of the pulses are reduced to flatter curves.

Settings: [Disabled, +/- 0.1%, +/- 0.2%, +/- 0.3%, +/- 0.4%, +/- 0.5%, +/- 0.6%, +/- 0.7%, +/- 0.8%, +/- 0.9%]

6.25. Load Optimized Defaults

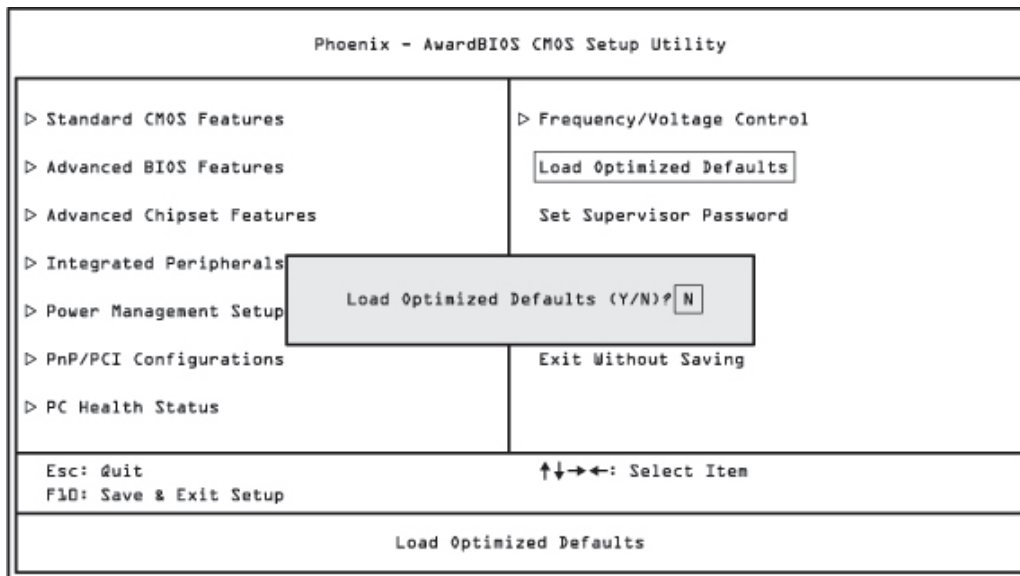

Figure 68: Illustration of the Load Optimized Defaults screen

This option is for restoring all the default optimized BIOS settings. The default optimized values are set by the board manufacturer to provide a stable system with optimized performance.

Entering "Y" and press <Enter> to load the default optimized BIOS values.

Entering "N" will cancel the load optimized defaults request.

6.26. Set Supervisor/User Password

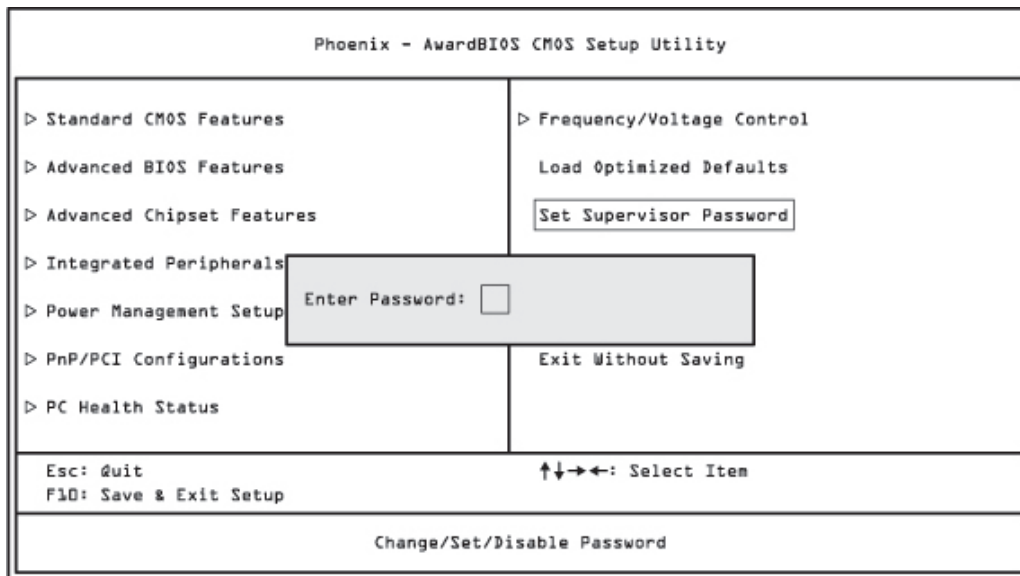

Figure 69: Illustration of the Set Supervisor/User Password screen

This option is for setting a password for entering BIOS Setup. When a password has been set, a password prompt will be displayed whenever BIOS Setup is run. This prevents an unauthorized person from changing any part of your system configuration.

There are two types of passwords you can set: Supervisor password and User password. When a supervisor password is used, the BIOS Setup program can be accessed and the BIOS settings can be changed. When a user password is used, the BIOS Setup program can be accessed but the BIOS settings cannot be changed.

To set the password, type the password (up to eight characters in length) and press **<Enter>**. The password typed now will clear any previously set password from CMOS memory. The new password will need to be reentered to be confirmed. To cancel the process press **<Esc>**.

To disable the password, press **<Enter>** when prompted to enter a new password. A message will show up to confirm disabling the password. To cancel the process press **<Esc>**.

Additionally, when a password is enabled, the BIOS can be set to request the password each time the system is booted. This would prevent unauthorized use of the system. See "Security Option" in the "Advanced BIOS Features" section for more details.

6.27. Save & Exit Setup

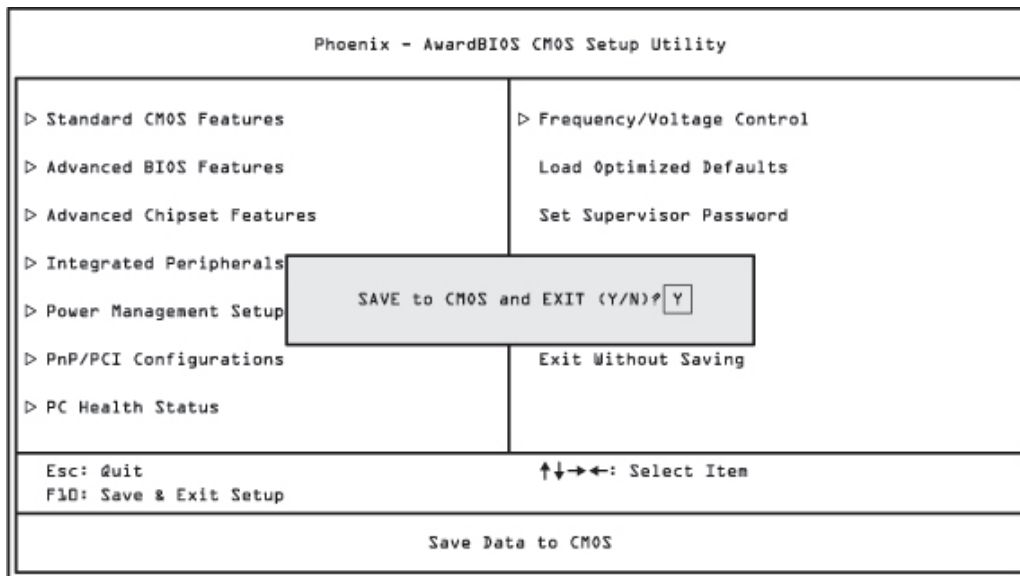

Figure 70: Illustration of the Save & Exit Setup screen

Entering “Y” saves any changes made, and exits the program.

Entering “N” will cancel the exit request.

6.28. Exit Without Saving

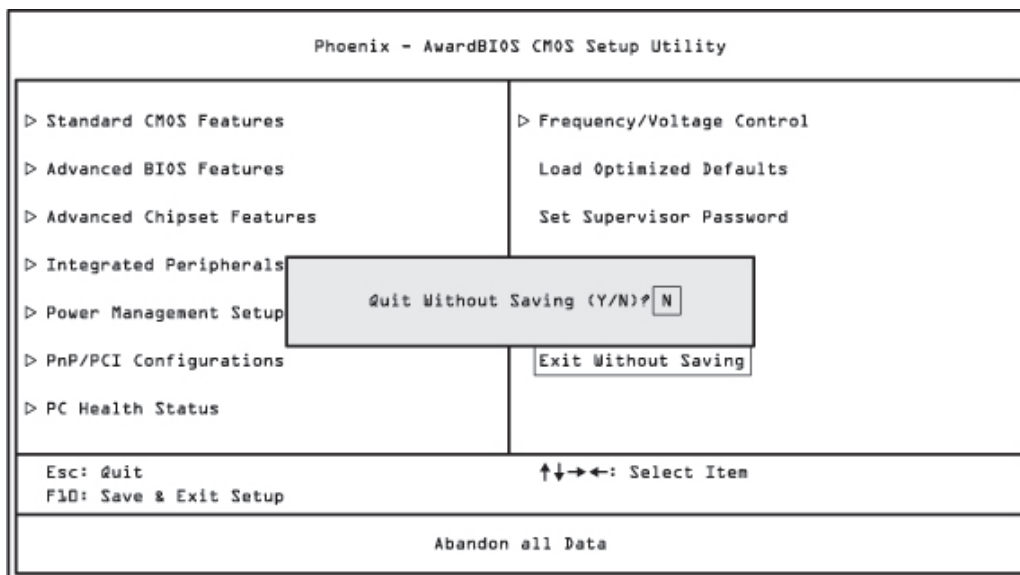

Figure 71: Illustration of the Exit Without Saving screen

Entering “Y” discards any changes made and exits the program.

Entering “N” will cancel the exit request

6.29. Main Menu (BIOS for VB7009-12QCE SKU)

The System Overview screen is the default screen that is shown when the BIOS Setup Utility is launched. This screen can be accessed by traversing the navigation bar to the “Main” label.

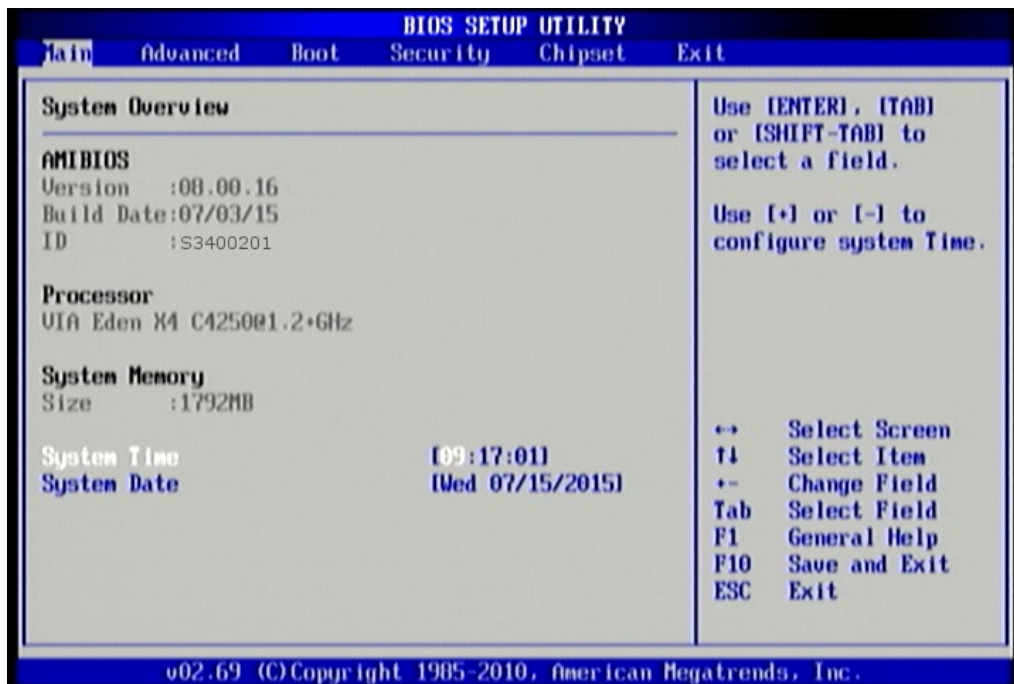

Figure 72: Illustration of the Main menu screen (for VB7009-12QCE SKU)

6.29.1. AMIBIOS

The content in this section of the screen shows the current BIOS version, build date, and ID number.

6.29.2. Processor

This content in this section shows the CPU information that has been detected. This information includes the CPU name and speed

6.29.3. System Memory

This section shows the amount of available memory that has been detected.

6.29.4. System Time

This section shows the current system time. Press **Tab** to traverse right and **Shift+Tab** to traverse left through the hour, minute, and second segments. The + and - keys on the number pad can be used to change the values. The time format is [Hour : Minute : Second].

6.29.5. System Date

This section shows the current system date. Press **Tab** to traverse right and **Shift+Tab** to traverse left through the month, day, and year segments. The + and - keys on the number pad can be used to change the values. The weekday name is automatically updated when the date is altered. The date format is [Weekday, Month, Day, Year].

6.30. Advanced Settings

The Advanced Settings screen shows a list of categories that can provide access to a sub-screen. Sub-screen links can be identified by the preceding right-facing arrowhead.

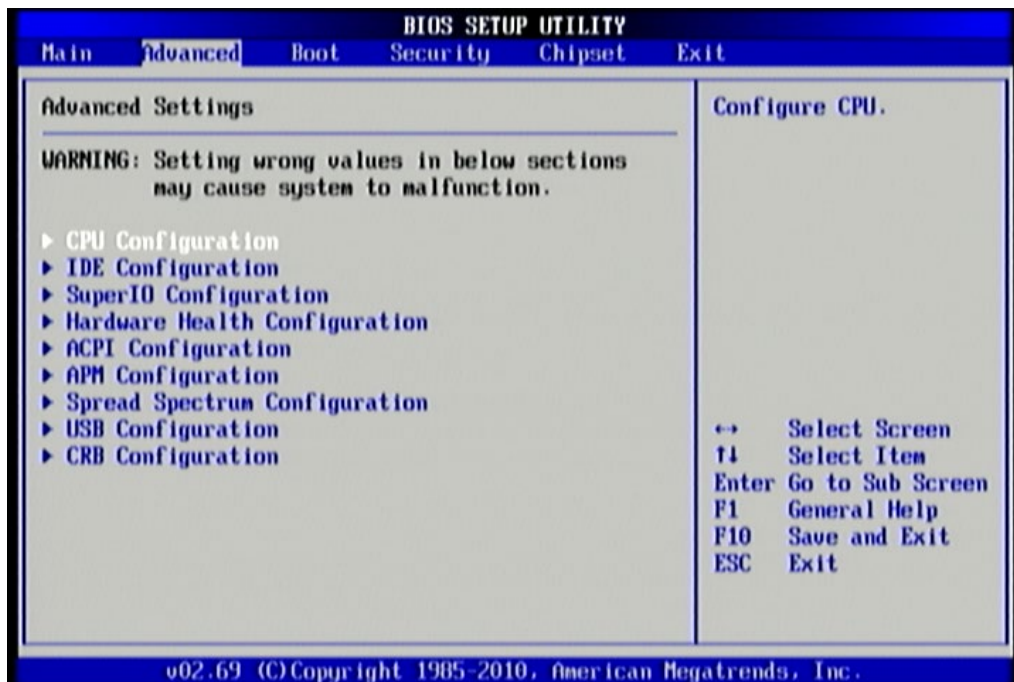

Figure 73: Illustration of the Advanced Settings screen

The Advanced Settings screen contains the following links:

- CPU Configuration
- IDE Configuration
- SuperIO Configuration
- Hardware Health Configuration
- ACPI Configuration
- APM Configuration
- Spread Spectrum Configuration
- USB Configuration
- CRB Configuration

6.30.1. CPU Configuration

The CPU Configuration screen shows detailed information about the built-in processor. In addition to the processor information, the thermal controls can be set.

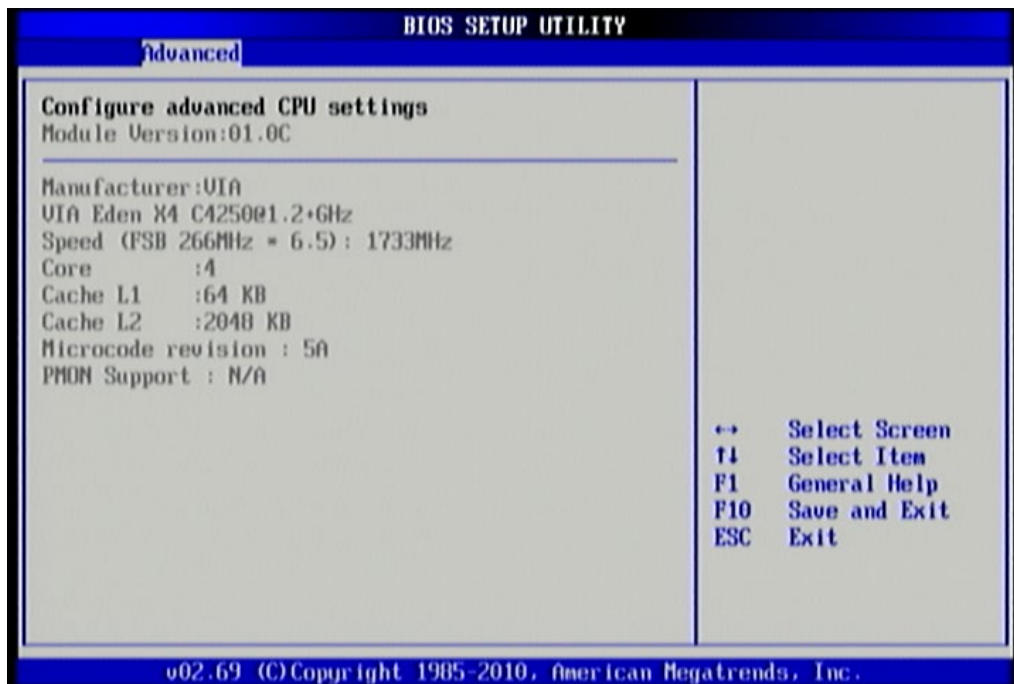

Figure 74: Illustration of the CPU Configuration screen

6.30.2. IDE Configuration

The IDE Configuration screen shows links to the primary master and slave IDE hard drive information screens.

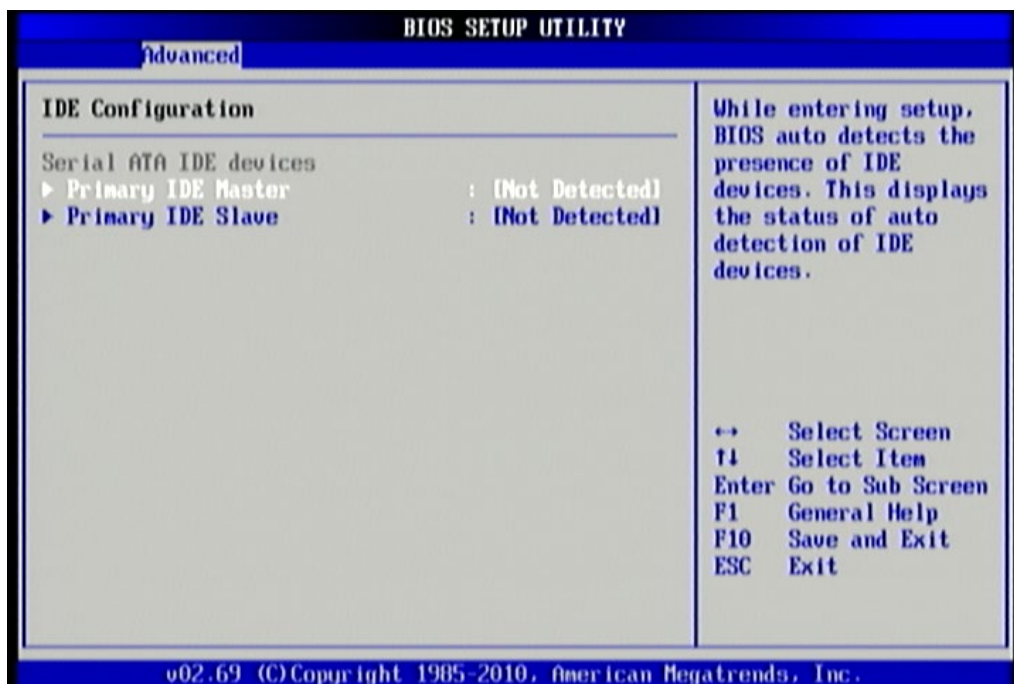

Figure 75: Illustration of IDE Configuration screen

6.30.3. SuperIO Configuration

The SuperIO Configuration screen shows the specific addresses and IRQs of the onboard serial ports.

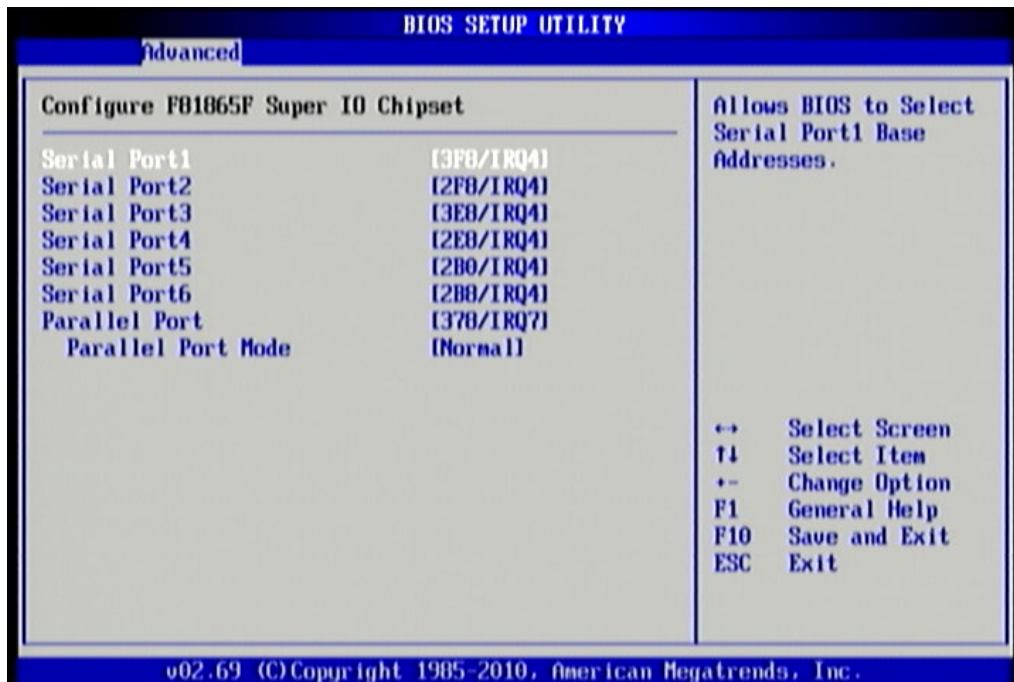

Figure 76: Illustration of SuperIO Configuration screen

6.30.3.1. Serial Ports 1 to 6 Address

The Serial Port 1 to 6 has three selectable options.

Port	Address and IRQs
1	3F8/IRQ4/Disabled
2	2F8/IRQ4/Disabled
3	3E8/IRQ4/Disabled
4	2E8/IRQ4/Disabled
5	2B0/IRQ4/Disabled
6	2B8/IRQ4/Disabled

Table 34: Serial port addresses and IRQs

6.30.3.2. Parallel Port

The Parallel Port has three selectable options: 378/IRQ7/Disabled.

6.30.3.2.1. Parallel Port Mode

The Parallel Port Mode has five selectable options: Normal/Bi-directional/ECP/EPP/ECP&EPP.

6.30.4. Hardware Health Configuration

The Hardware Health Configuration screen has no editable fields. The system temperature is taken from an optional sensor that is connected to the J5 pin header.

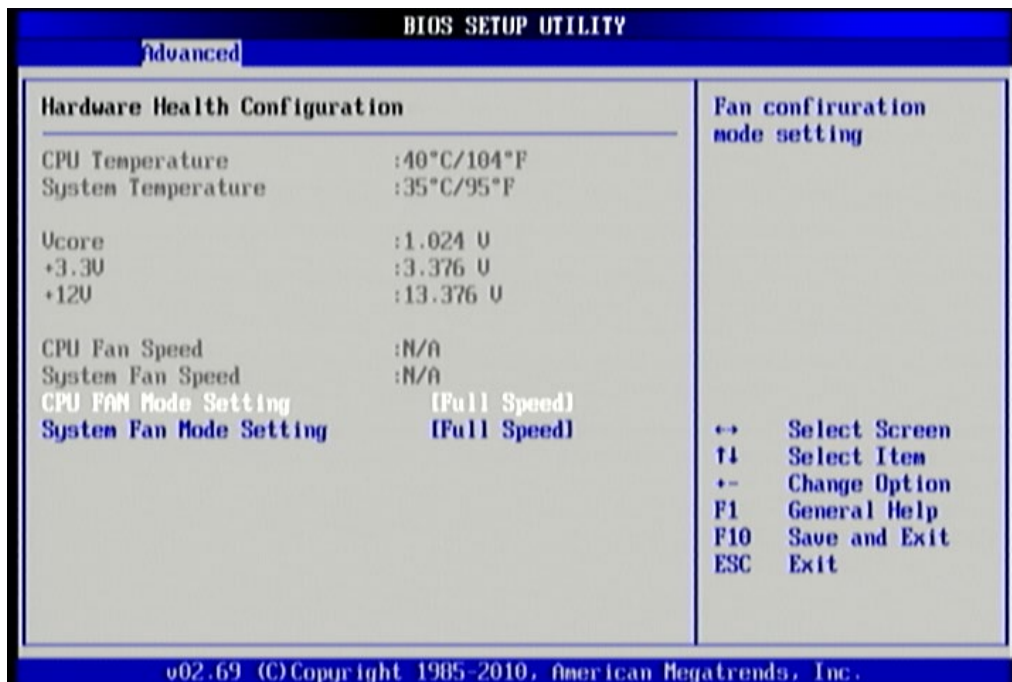

Figure 77: Illustration of Hardware Health Configuration screen

6.30.4.1. CPU FAN Mode Setting

The CPU FAN has two selectable mode options.

Auto Fan by RPM

The speed of the CPU fan is varied according to CPU temperature. Press Enter to do the following settings: CPU Temp. Limit of Highest/CPU Temp. Limit of Second/CPU Temp. Limit of Third/CPU Temp. Limit of Lowest/Fan 1 Highest Setting/Fan 1 Second Setting/Fan 1 Third Setting/Fan 1 Fourth Setting/Fan 1 Lowest Setting.

Full Speed

The CPU fan speed is fixed and running at highest speed.

6.30.4.2. System FAN Mode Setting

The System FAN has two selectable mode options.

Auto Fan by RPM

The speed of the system fan is varied according to system temperature. Press Enter to do the following settings: System Temp. Limit of Highest/System Temp. Limit of Second/System Temp. Limit of Third/System Temp. Limit of Lowest/Fan 2 Highest Setting/Fan 2 Second Setting/Fan 2 Third Setting/Fan 2 Fourth Setting/Fan 2 Lowest Setting.

Full Speed

The system fan speed is fixed and running at highest speed.

6.30.5. ACPI Settings

ACPI grants the operating system direct control over system power management. The ACPI Configuration screen can be used to set a number of power management related functions.

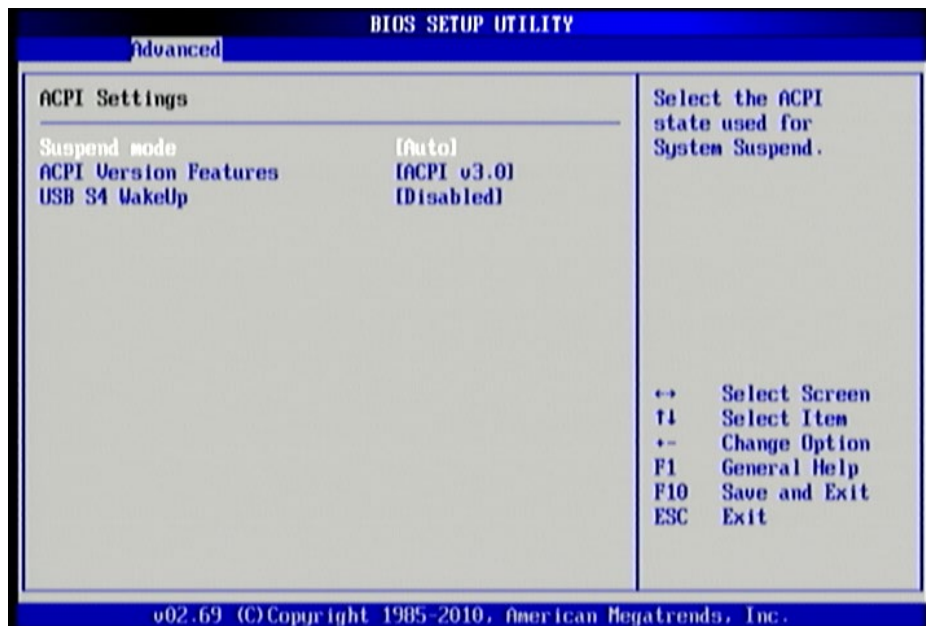

Figure 78: Illustration of ACPI Configuration screen

6.30.5.1. Suspend Mode

The Suspend Mode field has three selectable options.

S1 (POS)

S1/Power On Suspend (POS) is a low power state. In this state, no system context (CPU or chipset) is lost and hardware maintains all system contexts.

S3 (STR)

S3/Suspend To RAM (STR) is a power-down state. In this state, power is supplied only to essential components such as main memory and wakeup-capable devices. The system context is saved to main memory, and context is restored from the memory when a "wakeup" event occurs.

Auto

When the Suspend Mode is set to Auto, the operating system will control the power state.

6.30.5.2. ACPI Version Features

The ACPI Version has three selectable version options.

ACPI v1.0

Supports ACPI v1.0

ACPI v2.0

Supports ACPI v2.0

ACPI v3.0

Supports ACPI v3.0

6.30.5.3. USB S4 Wakeup

The USB S4 WakeUp enables the system to resume through the USB device port from S4 state. There are two options: "Enabled" or "Disabled".

6.30.6. APM Settings

APM enables the operating system to co-work with the BIOS to control the system power management. The APM Configuration screen can be used to set a number of power management functions.

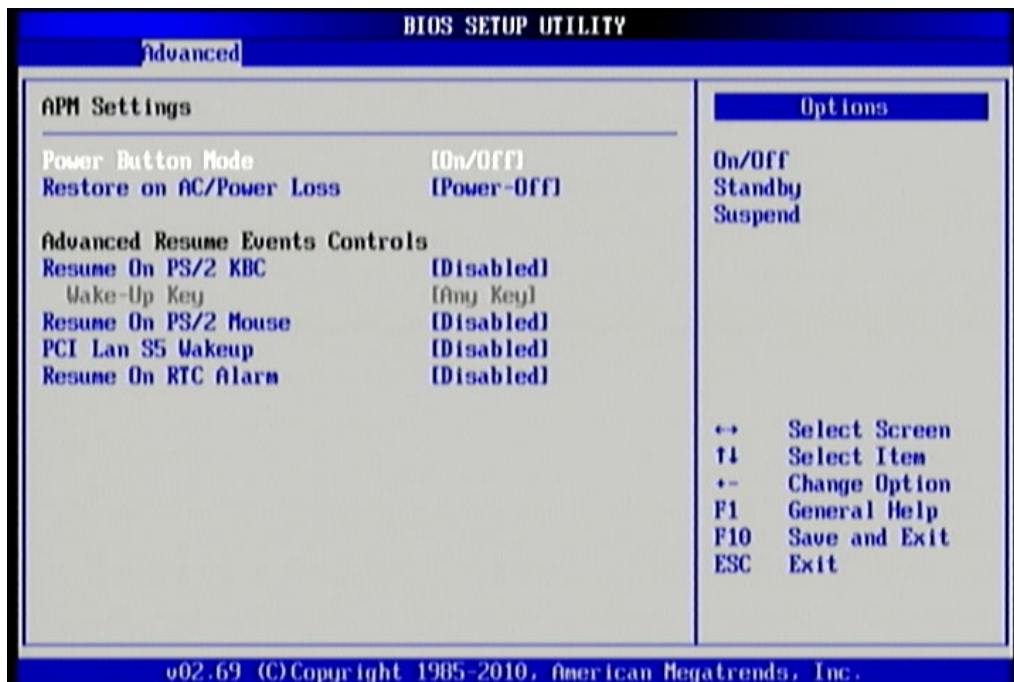

Figure 79: Illustration of APM Configuration screen

6.30.6.1. Power Button Mode

The Power Button Mode has three options.

On/Off

When On/Off is selected, pressing the power button will instantly cause the system to power on or off.

Standby

When Standby is selected, the power button must be pressed and held down for 4 seconds before the system will power off.

Suspend

When Suspend is selected, pressing the power button will instantly cause the system to enter suspend mode.

6.30.6.2. Restore on AC/Power Loss

Restore on AC/Power Loss defines how the system will respond after AC power has been interrupted while the system is on. There are three options.

Power Off

The Power Off option keeps the system in an off state until the power button is pressed again.

Power On

The Power On option restarts the system when the power has returned.

Last State

The Last State option restores the system to its previous state when the power was interrupted.

6.30.6.3. Resume on PS/2 KBC

Resume on PS/2 KBC wakes up a system that has been put into suspend or standby mode. When this feature is enabled, keyboard activity as defined in the **Wake-Up Key** feature will cause the system to wake up. This feature has three options.

S3/S4/S5

The S3/S4/S5 option enables PS/2 keyboard activity to be detected if the system is in S3/S4/S5 power saving mode.

Disabled

The Disabled option disables the detection of all PS/2 keyboard activity.

6.30.6.4. Wake-Up Key

The Wake-Up Key feature can only be set when **Resume on PS/2 KBC** is set to "S3/S4/S5". Otherwise, this feature will be not selectable. This feature has two options.

Any Key

The Any Key option enables any key on the keyboard to trigger the Wake-Up event.

Specific Key

The Specific Key option unlocks the **Wake-Up Password** feature.

6.30.6.5. Wake-Up Password

The Wake-Up Password feature can only be set when the **Wake-Up Key** feature is set to "Specific Key". This feature enables the user to specify a key sequence that must be entered in order to wake up the system.

The key sequence can consist of up to 6 alphanumeric characters and some special characters. Function keys and modifier keys (such as Ctrl, Alt, Del, etc.) cannot be used.

6.30.6.6. Resume on PS/2 Mouse

Resume on PS/2 Mouse wakes up a system that has been put into suspend or standby mode. When this feature is enabled, any PS/2 mouse activity that is detected will cause the system to wake up. This feature has three options.



Note:

This feature supports Erp/Eup provision.

S3

The S3 option enables any PS/2 mouse activity to be detected if the system is in S3 power saving mode.

S3/S4/S5

The S3/S4/S5 option enables any PS/2 mouse activity to be detected if the system is in S3/S4/S5 power saving mode.

Disabled

The Disabled option disables the detection of all PS/2 mouse activity.

6.30.6.7. PCI LAN S5 Wakeup

The PCI LAN S5 Wakeup feature enables the BIOS to allow remote wake-up from the S5 power off state through the PCI bus. This feature has two options: "Enabled" or "Disabled" support PCI LAN S5 Wakeup.

6.30.6.8. Resume on RTC Alarm

Resume on RTC Alarm can only be used if **Resume on Software RTC Alarm** is not enabled. This feature enables the BIOS to automatically power on the system at a scheduled time. When enabled, the **RTC Alarm Date** and **System Time** features will be unlocked.

6.30.6.9. RTC Alarm Date (Days)

The RTC Alarm Date feature is visible only when **Resume on RTC Alarm** is enabled. This feature enables the user to specify a specific date each month or daily recurrence. Use the **+** and **-** keys on the number pad to change the value of the RTC Alarm Date.

Every Day

The Every Day option triggers the RTC Alarm daily.

1 – 31

When a specific numeric date is selected, the RTC Alarm will be triggered on that day of the month.

6.30.6.10. System Time

The System Time option enables the user to specify the time the system should power on for the date that is set in **RTC Alarm Date**.

6.30.7. Spread Spectrum Configuration

The Spread Spectrum Configuration screen enables access to the Spread Spectrum Setting feature.

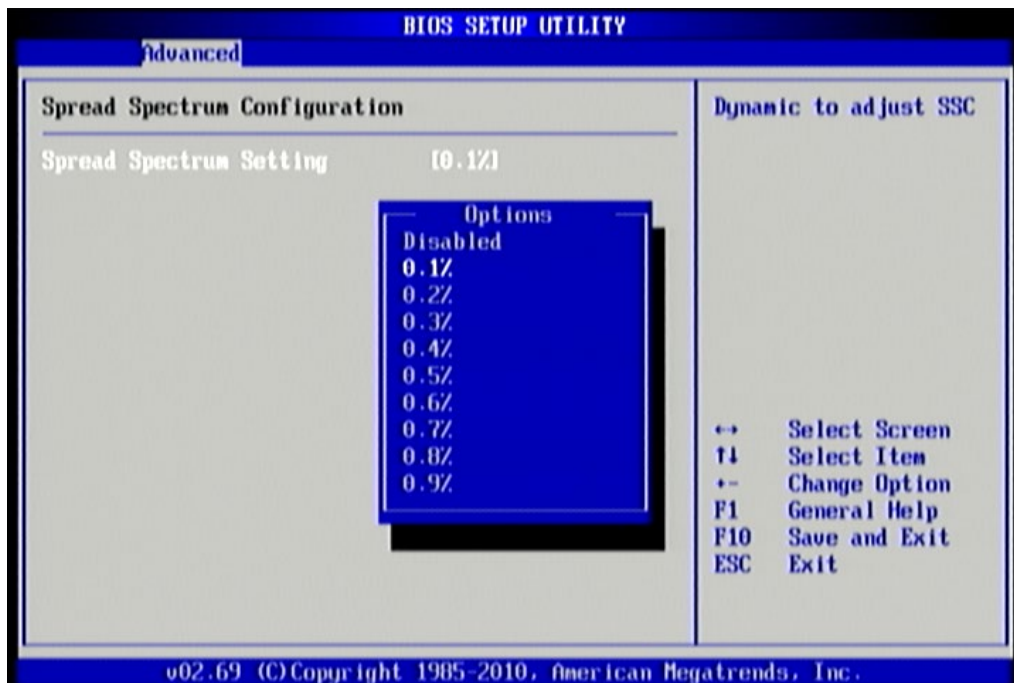

Figure 80: Illustration of Spread Spectrum Configuration screen

6.30.7.1. Spread Spectrum Setting

The Spread Spectrum Setting feature enables the BIOS to modulate the clock frequencies originating from the board. The settings are in percentages of modulation. Higher percentages result in greater modulation of clock frequencies. This feature has settings that range from 0.1% to 0.9%.

6.30.8. USB Configuration

The USB Configuration screen shows the number of connected USB devices.

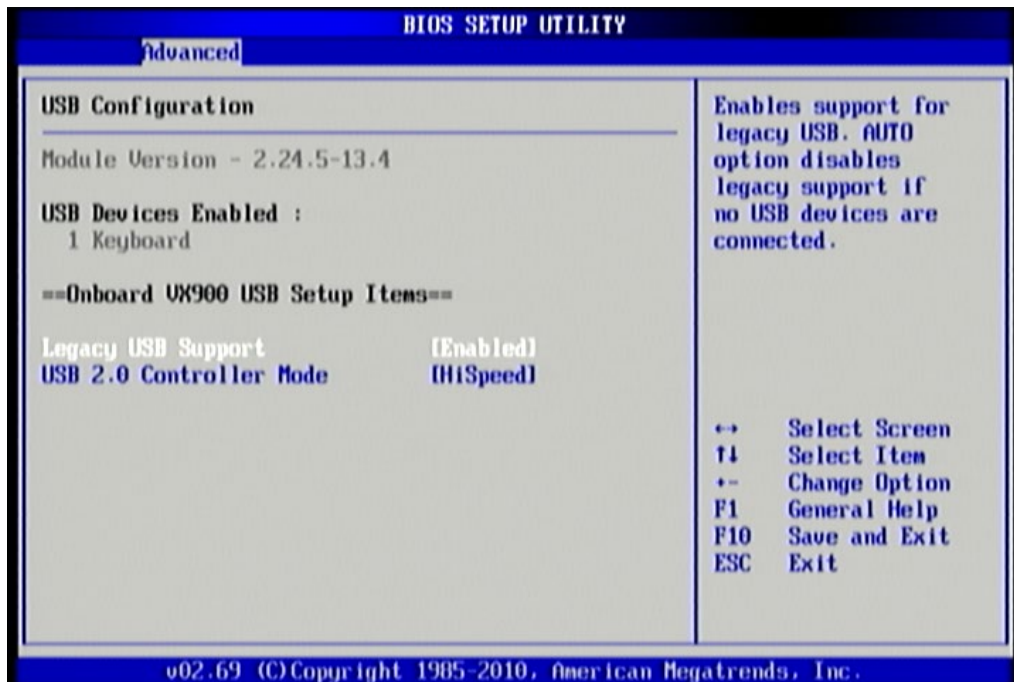

Figure 81: Illustration of USB Configuration screen

6.30.8.1. Legacy USB Support

The Legacy USB Support feature enables environments that do not have native USB support to use USB devices. This feature has three options.

Enabled

The Enabled option keeps the Legacy USB Support feature on at all times.

Disabled

The Disabled option keeps the Legacy USB Support feature off at all times.

6.30.8.2. USB2.0 Controller Mode

The USB 2.0 Controller Mode feature enables the user to set the USB 2.0 controller in HiSpeed (480Mbps) or FullSpeed (12Mbps) mode.

FullSpeed

The FullSpeed option limits the USB 2.0 controller to transfer data at 12Mbps.

HiSpeed

The HiSpeed option enables the USB 2.0 controller to transfer data at 480Mbps. The connected USB device must support USB 2.0 HiSpeed in order to benefit from this setting.

6.30.9. CRB Configuration

The CRB Configuration screen shows the available BIOS-controlled DRAM clock, graphics adapter, display device and LAN control features.

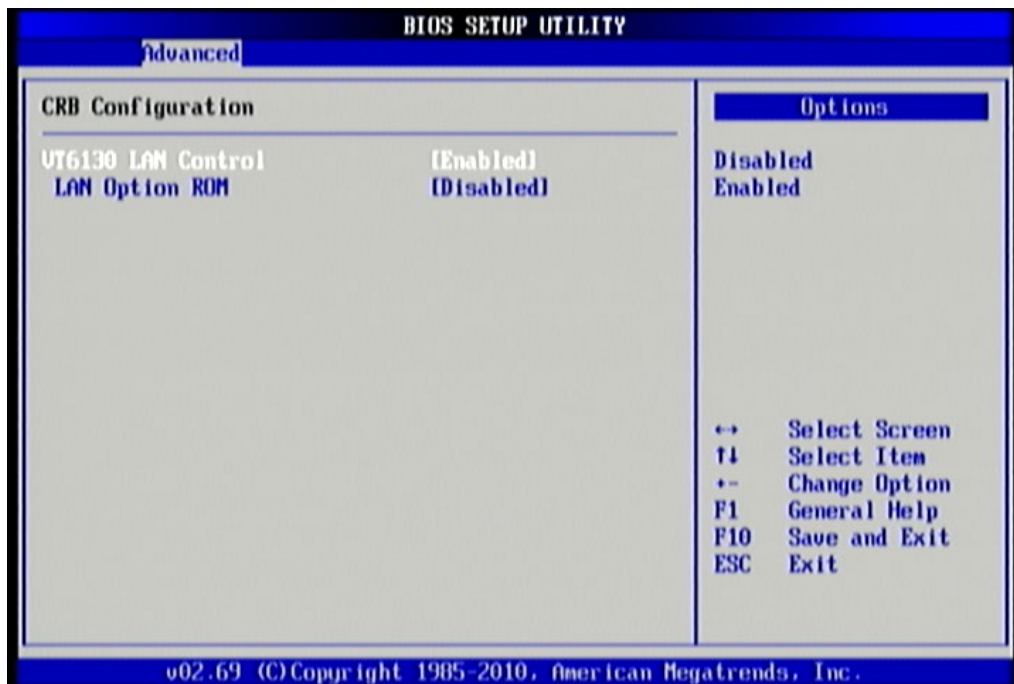

Figure 82: Illustration of CRB Configuration screen

6.30.9.1. VT6130 LAN Control

The VT6130 LAN Control feature determines whether the onboard LAN controller will be used or not.

6.30.9.2. LAN Option ROM

The LAN Option ROM feature will only be visible if the **VT6130 LAN Control** feature is enabled. If the LAN Option ROM feature is enabled, then the system will load a separate ROM for the LAN controller in order to boot from Gigabit LAN.

6.31. Boot Settings

The Boot Settings screen has a single link that goes to the **Boot Settings Configuration** screen.

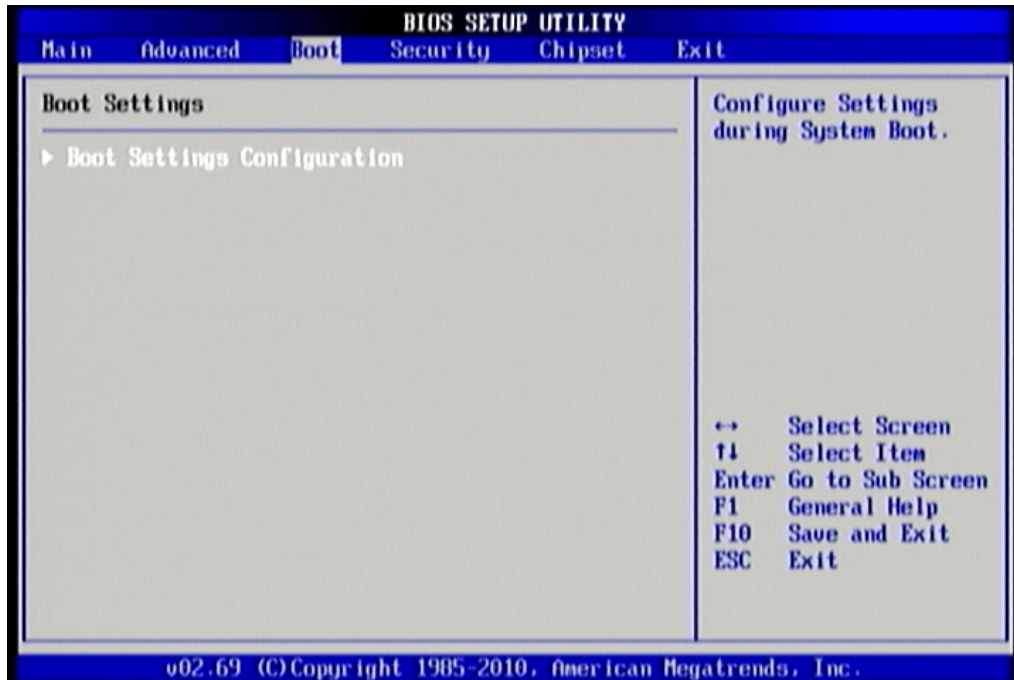

Figure 83: Illustration of Boot Settings screen

6.31.1. Boot Settings Configuration

The Boot Settings Configuration screen has several features that can be run during the system boot sequence.

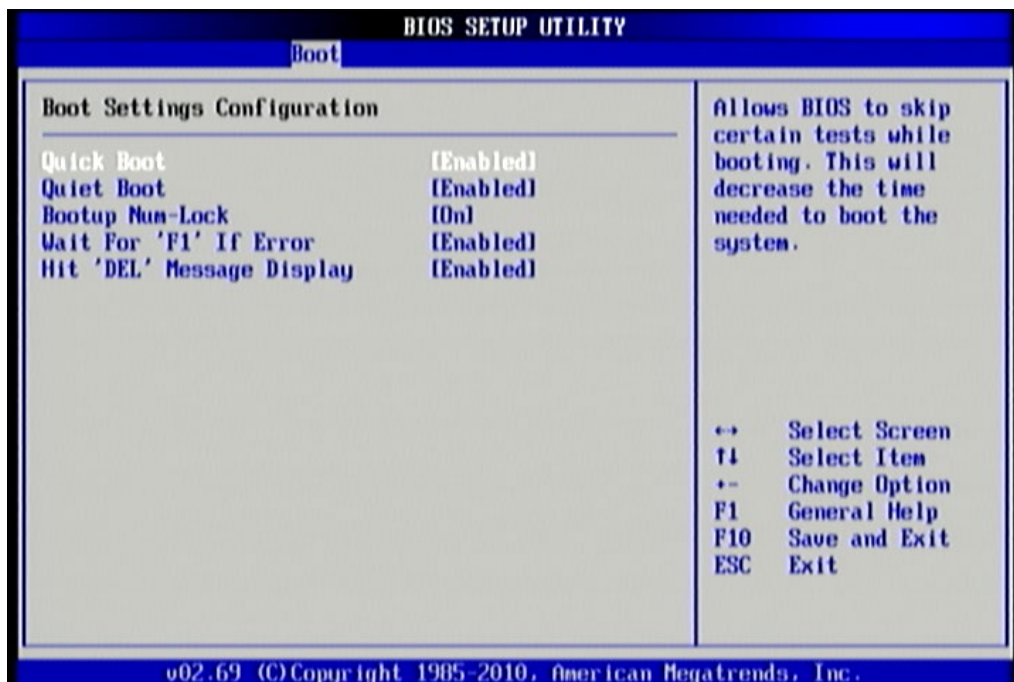

Figure 84: Illustration of Boot Settings Configuration screen

6.31.1.1. Quick Boot

The Quick Boot feature enables the BIOS to skip certain tests in order to speed up the boot sequence. This feature has two options: enabled and disabled.

6.31.1.2. Quiet Boot

The Quiet Boot feature hides all of the Power-on Self Test (POST) messages during the boot sequence. Instead of the POST messages, the user will see an OEM logo. This feature has two options: enabled and disabled.

6.31.1.3. Bootup Num-Lock

The Bootup Num-Lock feature determines how the 10-key pad will behave. When the feature is enabled, the 10-key pad will behave as a number pad. When the feature is disabled, the 10-key pad will behave as cursor navigation keys.

6.31.1.4. Wait for 'F1' if Error

This feature determines how the system will respond if an error is detected during the boot sequence. If this feature is enabled, the BIOS will pause booting and wait for the user to press F1 to enter the BIOS setup menu. This feature has two options: enabled and disabled.

6.31.1.5. Hit 'DEL' Message Display

This feature determines if the BIOS will display a POST message that informs the user how to access the BIOS Setup Utility. This feature has two options: enabled and disabled.



Note:

If the Quiet Boot option is enabled, the settings of this feature will have no effect.

6.32. Security Settings

The Security Settings screen provides a way to restrict access to the BIOS or even the entire system.

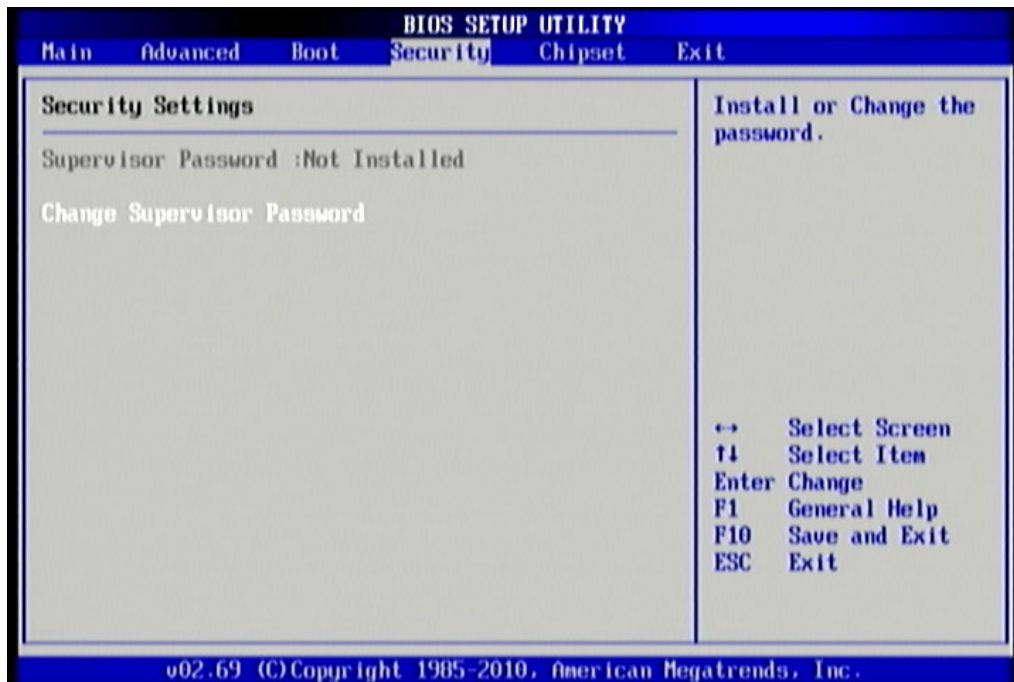

Figure 85: Illustration of Security Settings screen

6.32.1. Security Settings

6.32.1.1. Change Supervisor Password

This option is for setting a password for accessing the BIOS setup utility. When a password has been set, a password prompt will be displayed whenever the BIOS setup utility is launched. This prevents an unauthorized person from changing any part of the system configuration.

When a supervisor password is set, the **Password Check** option will be unlocked.

6.32.1.2. Password Check

This feature is compulsory when the **Change Supervisor Password** option is set. The user will have up to three chances to enter the correct password before the BIOS forces the system to stop booting. If the user does not enter the correct password, the keyboard will also lock up. The only way to get past this is to do a hard reboot (i.e., use the system reset button or cut off the power to the system). A soft reboot (i.e., Ctrl+Alt+Del) will not work because the keyboard will be locked. This feature has two options.

Setup

The Setup option forces users to enter a password in order to access the BIOS Setup Utility.

Always

The Always option forces users to enter a password in order to boot up the system.

6.33. Advanced Chipset Settings

The Advanced Chipset Settings screen has two links for accessing North and South bridge functions. Though the VX900 is a single chip solution, the North and South bridge categories are still for grouping features.

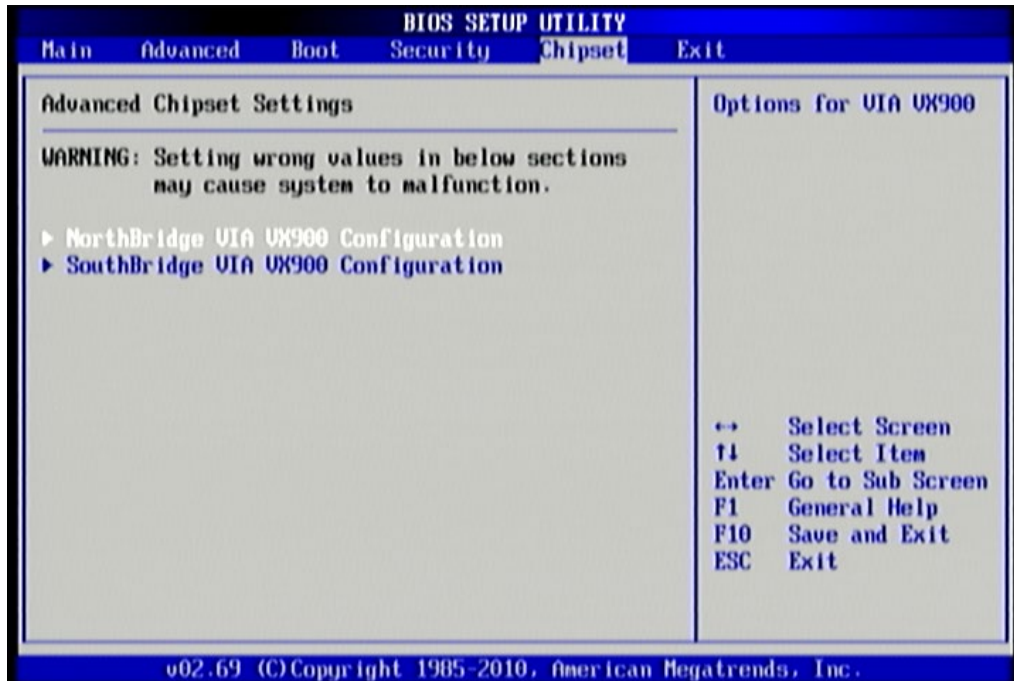

Figure 86: Illustration of Advanced Chipset Settings screen

6.33.1. North Bridge VIA VX900 Configuration

The North Bridge VIA VX900 Configuration screen contains two links to sub-screen.

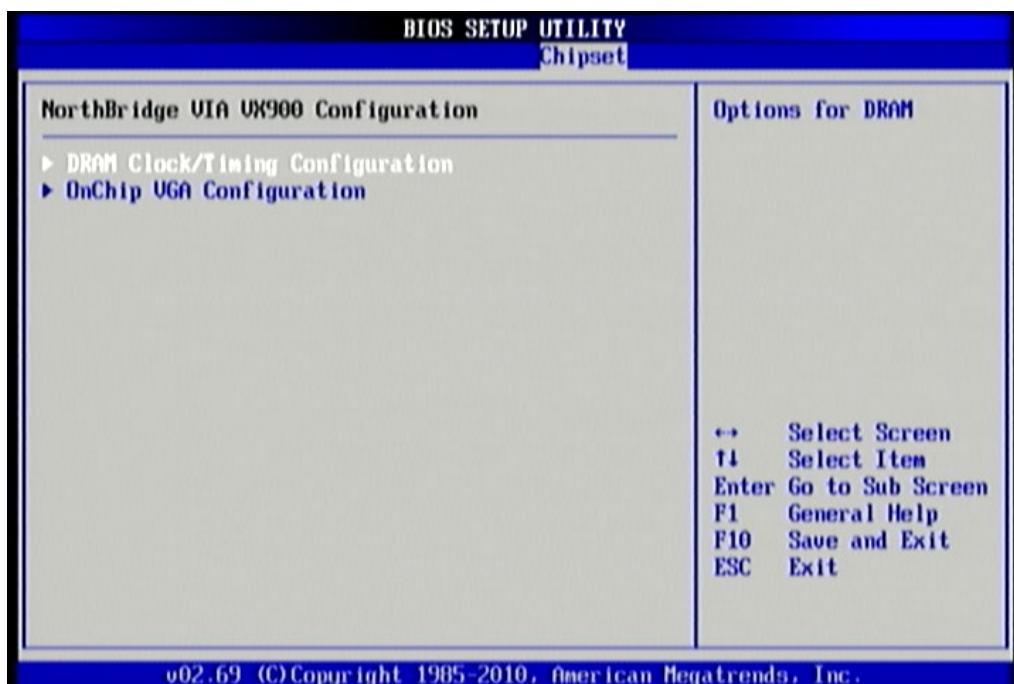

Figure 87: Illustration of North Bridge VIA VX900 Configuration screen

6.33.1.1. DRAM Clock/Timing Configuration

The DRAM Clock/Timing Configuration screen has one feature for controlling the system DRAM. All other DRAM features are automated and cannot be accessed.

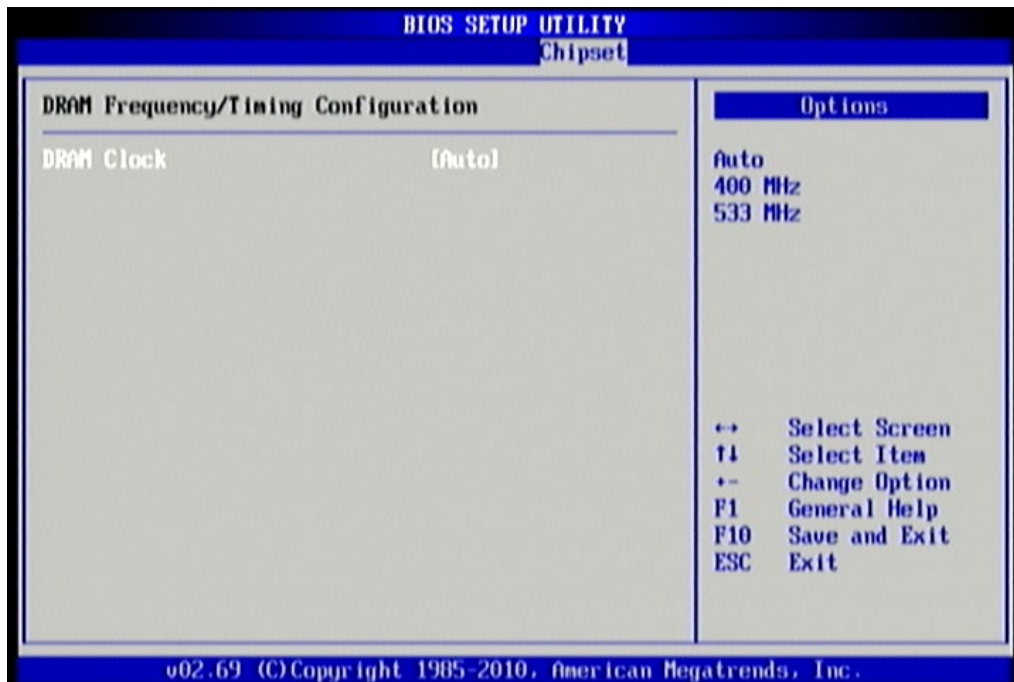

Figure 88: Illustration of DRAM Frequency/Timing Configuration screen

6.33.1.1.1. DRAM Clock

The DRAM Clock option enables the user to determine how the BIOS handles the memory clock frequency. The memory clock can either be dynamic or static. This feature has three options.

Auto

The Auto option enables the BIOS to select a compatible clock frequency for the installed memory.

400MHz

The 400MHz option forces the BIOS to be fixed at 800MHz for DDR3 memory modules.

533MHz

The 533MHz option forces the BIOS to be fixed at 1066MHz for DDR3 memory modules.

6.33.1.2. OnChip VGA Configuration

The OnChip VGA Configuration screen has features for controlling the integrated graphics controller in the VX900 chipset.

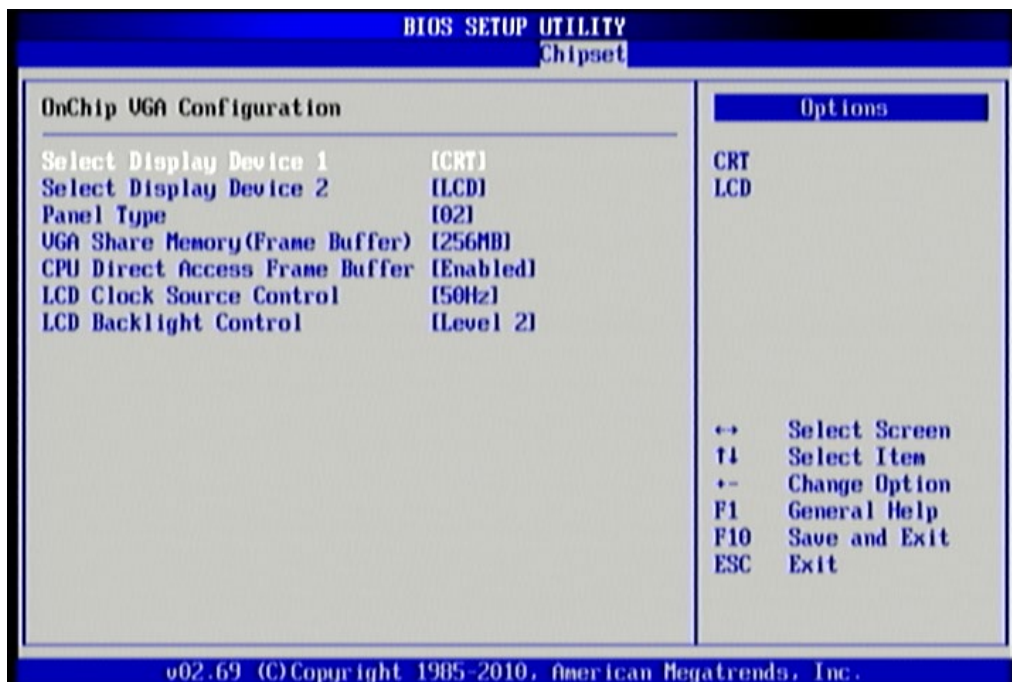

Figure 89: Illustration of OnChip VGA Configuration screen

6.33.1.2.1. Select Display Device 1 and 2

The Select Display Device feature enables the user to choose a specific display interface. This feature has two options: CRT and LCD. If both Select Display Device 1 and Select Display Device 2 are set to the same interface, then any display device connected to the other interface will not function. For example, if both Select Display 1 and 2 are set to CRT, then no data will be sent to the LCD port.

6.33.1.2.2. Panel Type

The Panel Type feature enables the user to specify the resolution of the display being used with the system. The panel types are predefined in the VGA VBIOS.

Panel Type	Resolution	Panel Type	Resolution
00	640 × 480	08	800 × 480
01	800 × 600	09	1024 × 600
02	1024 × 768	10	1366 × 768
03	1280 × 768	11	1600 × 1200
04	1280 × 1024	12	1680 × 1050
05	1400 × 1050	13	1920 × 1200
06	1440 × 900	14	1920 × 1080
07	1280 × 800	15	1024 × 576

6.33.1.2.3. VGA Share Memory (Frame Buffer)

The VGA Share Memory feature enables the user to choose the amount of the system memory to reserve for use by the integrated graphics controller. The selections of memory amount that can be reserved are 128MB, 256MB and 512MB.

6.33.1.2.4. CPU Direct Access Frame Buffer

The CPU Direct Access Frame Buffer feature enables the CPU to write to the portion of memory reserved for the integrated graphics controller. This feature has two options: "Disabled" and "Enabled".

6.33.1.2.5. LCD Clock Source Control

The clock source for LCD backlights control. This feature has four options: 14KHz/7KHz/110Hz/50Hz.

6.33.1.2.6. LCD Backlight Control

The Backlight Control feature control by VX900 enables the user to control the brightness of the LCD backlight. This feature has five options.

Level 1 0% PWM Duty

Level 1 25% PWM Duty

Level 2 50% PWM Duty

Level 3 75% PWM Duty

Level 4 100% PWM Duty

6.33.2. South Bridge VIA VX900 Configuration

The South Bridge VIA VX900 Configuration screen has the following features.

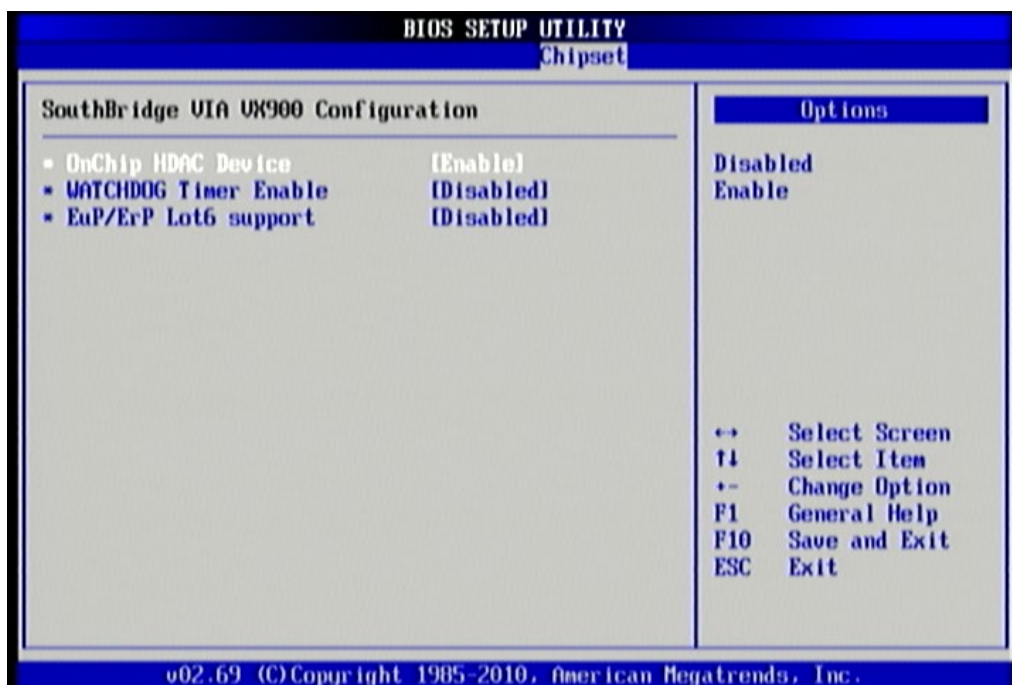

Figure 90: Illustration of South Bridge VIA VX900 Configuration screen

6.33.2.1. OnChip HDAC Device

The OnChip HDAC Device feature enables the BIOS to control the high definition audio codec in the chipset. This feature has two options: "Enable" or "Disabled".

6.33.2.2. WATCHDOG Timer Enable

The WATCHDOG Timer Enable feature unlocks three other features that enable the BIOS to monitor the state of the system. This feature has two options: "Enabled" or "Disabled".

6.33.2.3. Eup/ErP Lot6 support

The EuP/ErP Lot6 Support feature enables the BIOS to reduce the power draw to less than 1W when the system is in standby mode. This feature has two options: enabled and disabled.

6.34. Exit Options

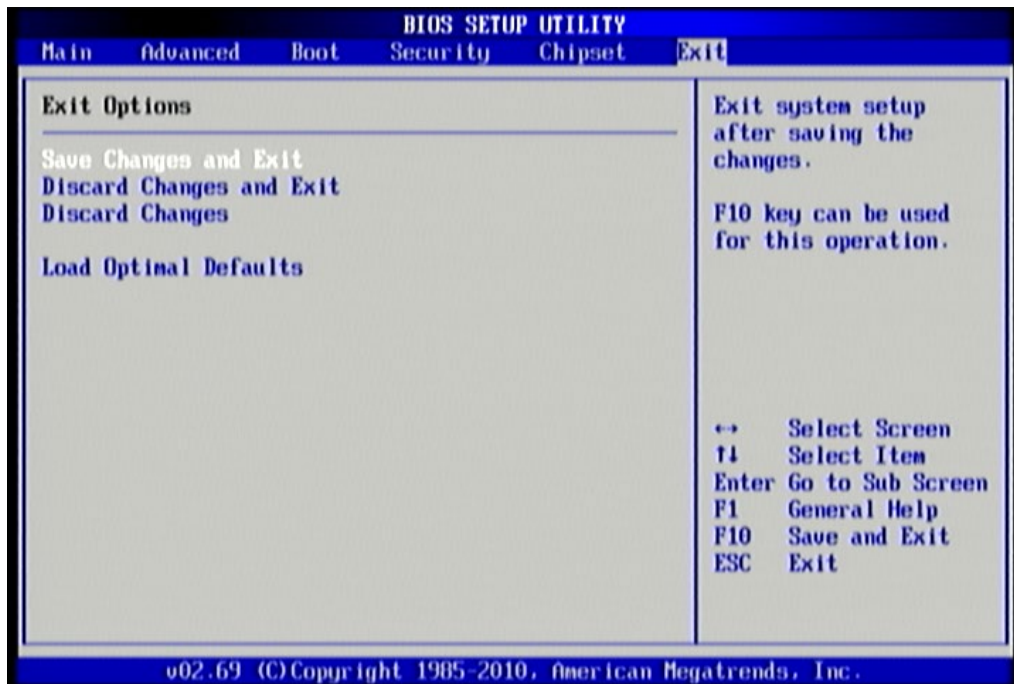

Figure 91: Illustration of Exit Options screen

6.34.1. Save Changes and Exit

Save all changes to the BIOS and exit the BIOS Setup Utility. The “F10” hotkey can also be used to trigger this command.

6.34.2. Discard Changes and Exit

Exit the BIOS Setup Utility without saving any changes. The “Esc” hotkey can also be used to trigger this command.

6.34.3. Discard Changes

This command reverts all changes to the settings that were in place when the BIOS Setup Utility was launched.

6.34.4. Load Optimal Defaults

Load optimal default values for all the setup items. The default optimized values are defined by the board manufacturer to provide optimized environment for a basic system.

7. Software and Technical Support

7.1 Microsoft and Linux Support

The VIA VB7009 is compatible with Microsoft Windows and Linux operating systems.

7.1.1. Driver Installation

Microsoft Driver Support

The latest windows drivers can be downloaded from the VIA website at <https://www.viatech.com>.

Linux Driver Support

Linux drivers are provided through various methods including:

- Drivers provided by VIA (binary only). An ARCM or NDA/BSLA may be asked in order to get the drivers, please contact our sales representative to submit a request.
- Using a driver built into a distribution package.
- Installing a third party driver (such as the ALSA driver from the Advanced Linux Sound Architecture project for integrated audio).

7.2 Technical Support and Assistance

- For utilities downloads, latest documentation and information about the VIA VB7009, please visit our website at <https://www.viatech.com/en/products/boards/embedded-boards/vb7009>.
- For technical support and additional assistance, always contact your local sales representative or board distributor, or go to <https://www.viatech.com/en/support/technical-support>.
- For OEM clients and system integrators developing a product for long term production, other code and resources may also be made available. Please visit our website at <https://www.viatech.com/en/about/contact> to submit a request.

Appendix A. Installing Wireless Accessories

This chapter provides you with information on how to install the VIA EMIO wireless module into the VIA VB7009. It is recommended to use a grounded wrist strap before handling computer components. Electrostatic discharge (ESD) can damage some components.

A.1. Installing the VIA EMIO-1533 USB Wi-Fi Module

Step 1

Mount the VIA EMIO-1533 module to the prepared standoff in the chassis. Align the two mounting holes on the VIA EMIO-1533 module with the mounting holes on the standoffs. And then secure the VIA EMIO-1533 module in place with two screws.

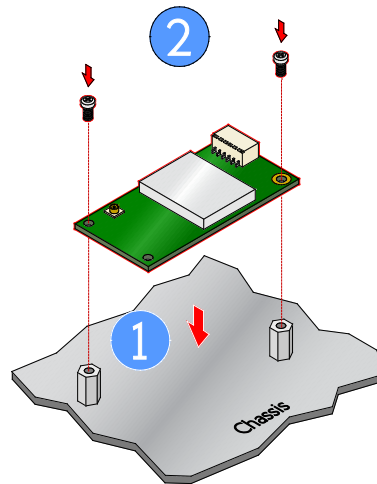

Figure 92: Installing the VIA EMIO-1533 module to the chassis

Step 2

Connect one end of USB Wi-Fi cable to pin 1, 3, 5, and 7 of onboard USB 2.0 pin header (USB_4 or USB_5) on VIA VB7009, and then connect the other end of the cable to the VIA EMIO-1533 module.

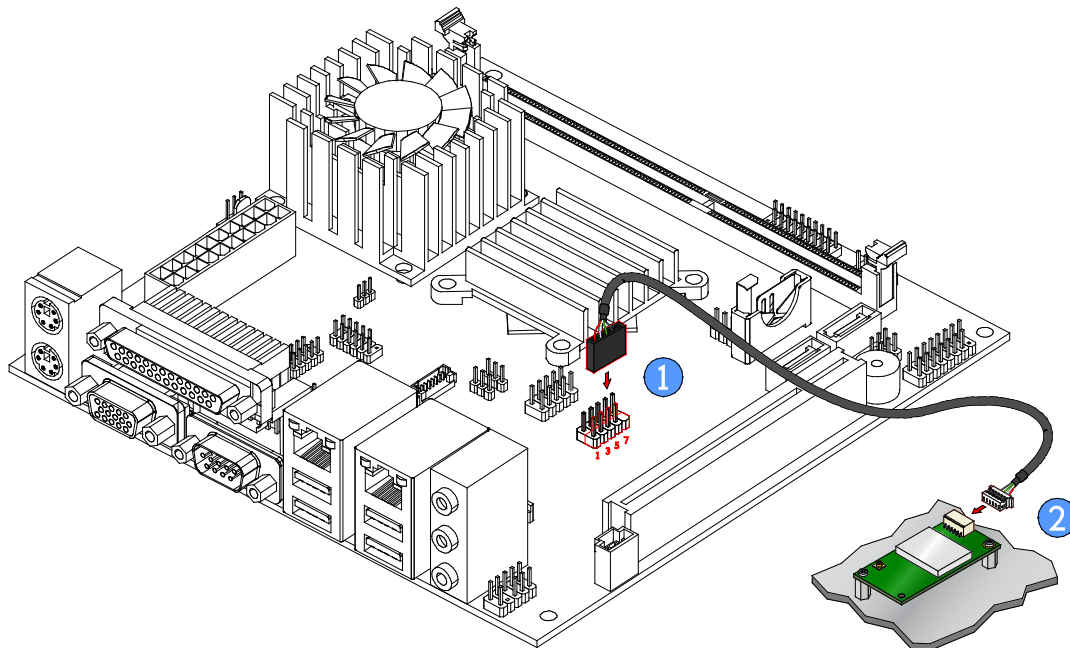

Figure 93: Connecting the USB Wi-Fi cable (VIA EMIO-1533)

Step 3

Insert the Wi-Fi antenna cable into the antenna hole from the inside of the panel I/O plate. Insert the toothed washer, fasten it with the nut and install the external antenna.

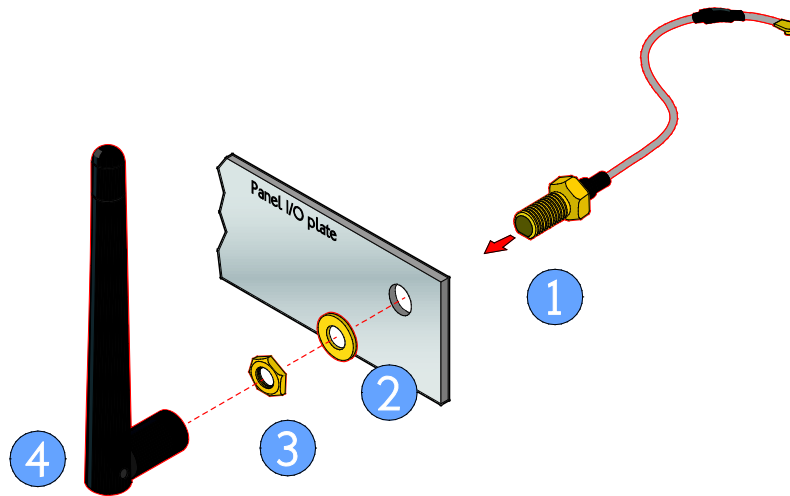

Figure 94: Installing Wi-Fi antenna cable (VIA EMIO-1533)

Step 4

Connect the other end of the Wi-Fi antenna cable to the micro-RF connector labeled "I-PEX" on the VIA EMIO-1533 module.

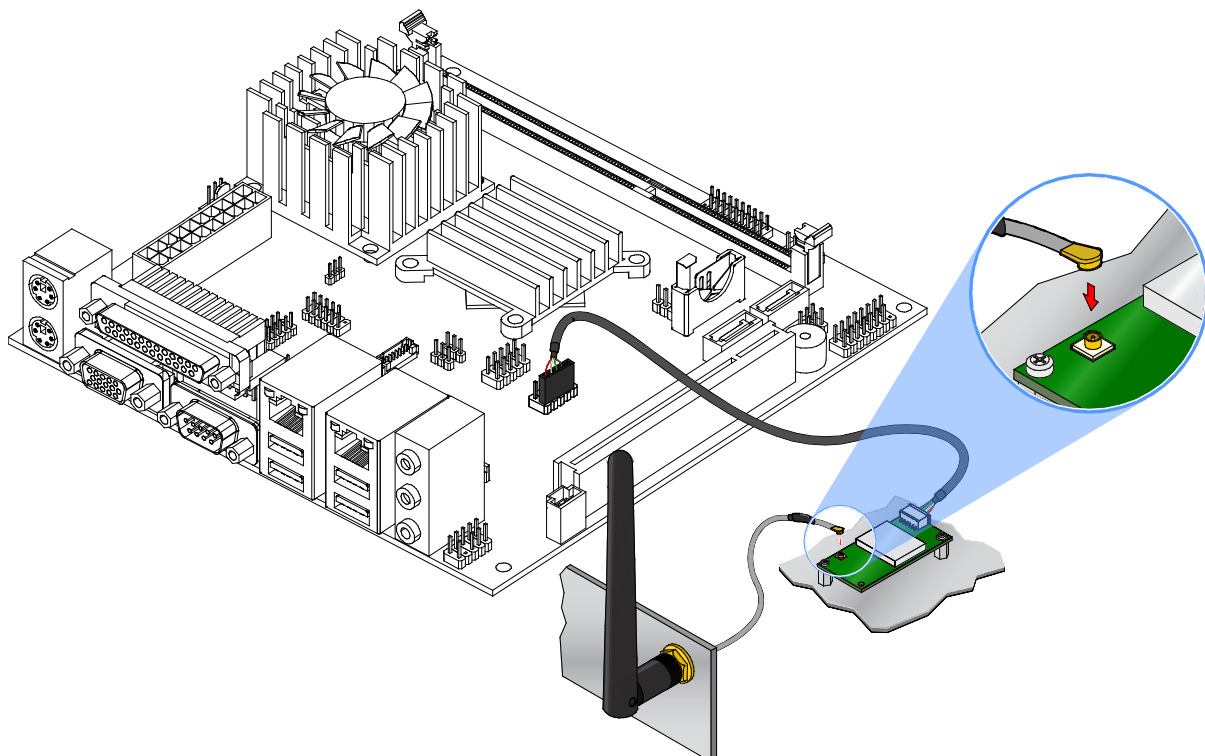

Figure 95: Connecting Wi-Fi antenna cable to the micro-RF connector (VIA EMIO-1533)

A.2. Installing the VIA EMIO-5531 USB Wi-Fi & Bluetooth Module

Step 1

Mount the VIA EMIO-5531 module to the prepared standoff in the chassis. Align the two mounting holes on the VIA EMIO-5531 module with the mounting holes on the standoffs. And then secure the VIA EMIO-5531 module in place with two screws.

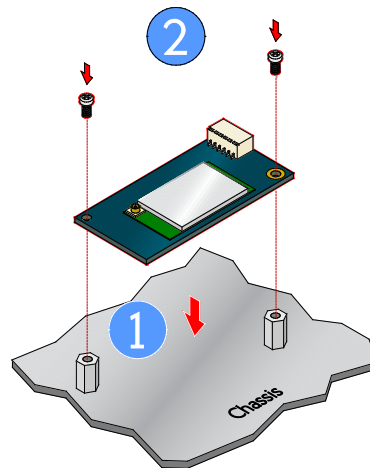

Figure 96: Installing the VIA EMIO-5531 module to the chassis

Step 2

Connect one end of USB Wi-Fi cable to pin 1, 3, 5, and 7 of onboard USB 2.0 pin header (USB_4 or USB_5) on VIA VB7009, and then connect the other end of the cable to the VIA EMIO-5531 module.

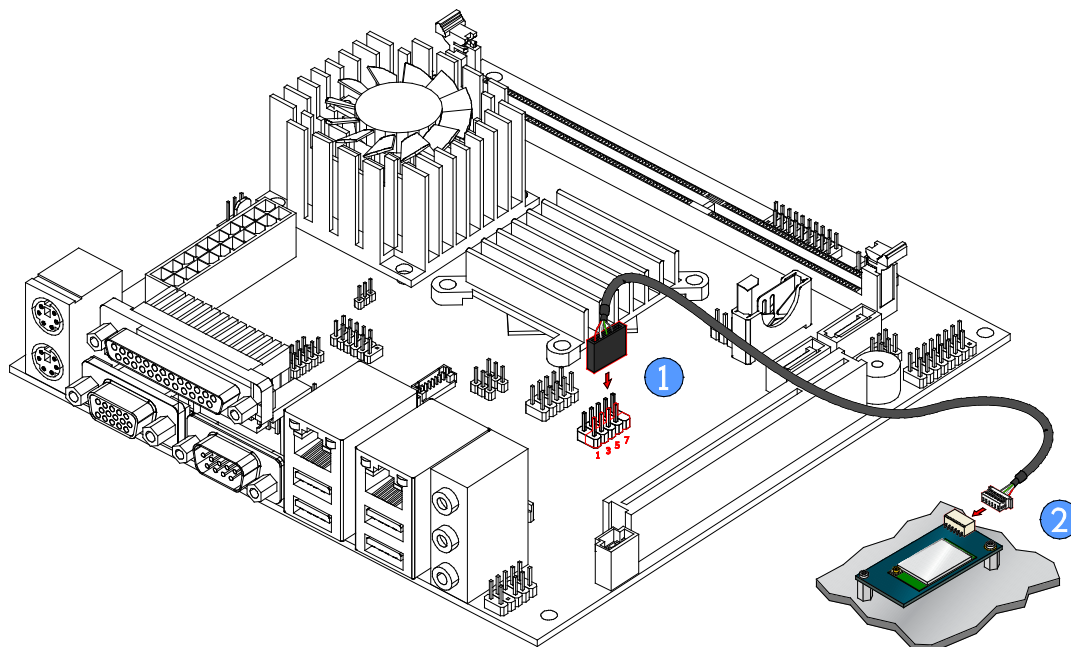

Figure 97: Connecting the USB Wi-Fi cable (VIA EMIO-5531)

Step 3

Insert the Wi-Fi antenna cable into the antenna hole from the inside of the panel I/O plate. Insert the toothed washer, fasten it with the nut, and install the external antenna.

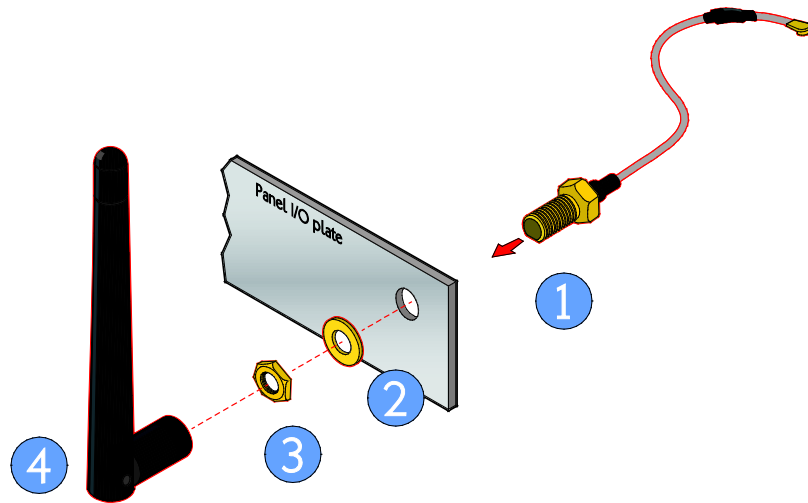

Figure 98: Installing Wi-Fi antenna cable (VIA EMIO-5531)

Step 4

Connect the other end of the Wi-Fi antenna cable to the micro-RF connector labeled "I-PEX" on the VIA EMIO-5531 module.

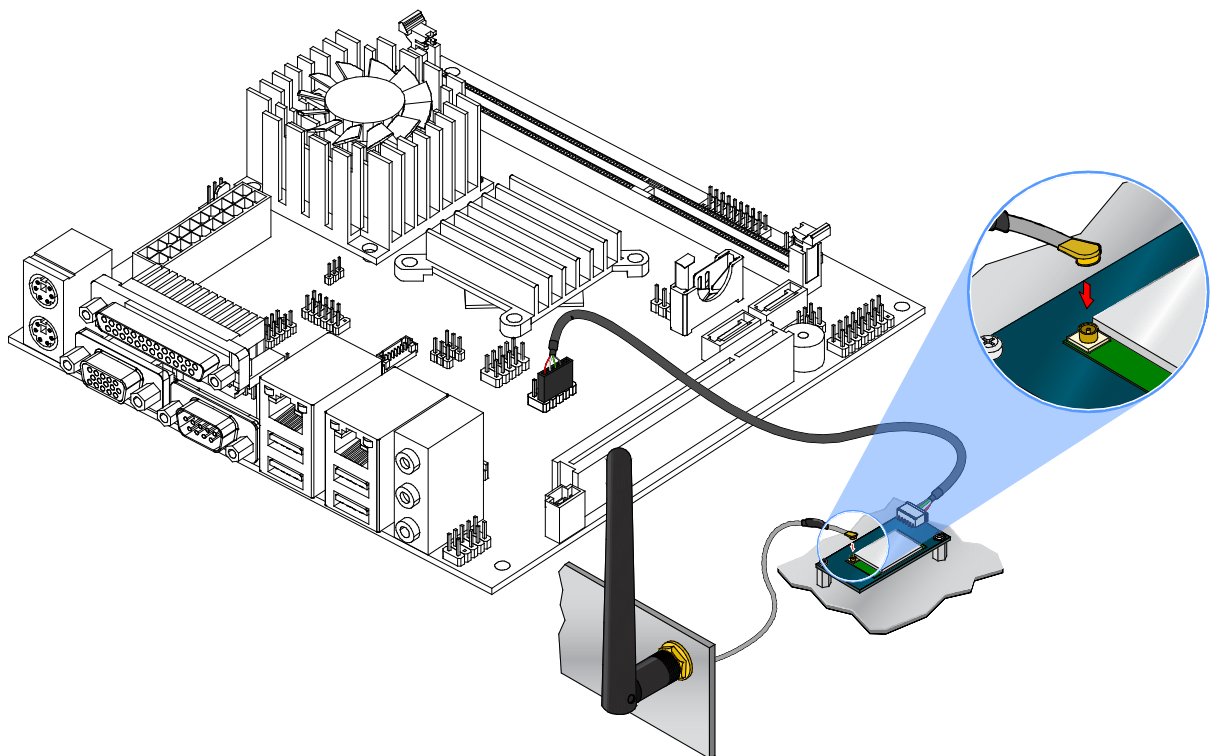

Figure 99: Connecting Wi-Fi antenna cable to the micro-RF connector (VIA EMIO-5531)

Appendix B. Power Consumption Report

Power consumption tests were performed on the VIA VB7009. The following tables represent the breakdown of the voltage, amp and wattage values while running common system applications.

B.1. VB7009-16

The tests were performed based on the following additional components:

- **CPU:** VIA C7[®]-D 1.6GHz
- **Chipset:** VX900
- **Memory:** DDR3 DIMM Kingston HyperX 1600MHz 4GB
- **HDD SATA:** Fujitsu MJA2250BH 250GB
- **DVD-ROM:** Sony CRX890S
- **Power Supply:** ATX power supply SevenTeam ST-350GL 350W
- **Operating System:** Windows 7 32-bit

B.1.1. System Idle – Windows 7 32-bit

Power Plane	Volts	Amperes	Watts
+3.3V	3.161	0.650	2.055
+5V	4.845	3.080	14.923
+5VSB	5.033	0.068	0.342
+12V	11.975	0.086	1.030
		Total Power Consumption	18.350

B.1.2. S3 Status – Windows 7 Sleep

Power Plane	Volts	Amperes	Watts
+3.3V	-0.019	0.000	0.000
+5V	-0.010	0.011	0.000
+5VSB	5.080	0.370	1.880
+12V	-0.020	0.009	0.000
		Total Power Consumption	1.880

B.1.3. MP3 Playback – Windows Media Player10

Power Plane	Volts	Amperes	Watts
+3.3V	3.192	0.680	2.171
+5V	4.917	2.240	11.014
+5VSB	5.104	0.057	0.291
+12V	11.998	0.086	1.032
		Total Power Consumption	14.508

B.1.4. DVD Playback – PowerDVD 8.0

Power Plane	Volts	Amperes	Watts
+3.3V	2.955	0.650	1.921
+5V	4.675	4.153	19.415
+5VSB	4.857	0.112	0.544
+12V	11.905	0.078	0.929
		Total Power Consumption	22.809

B.1.5. Graphics – Run 3DMarks'06

Power Plane	Volts	Amperes	Watts
+3.3V	2.979	0.660	1.966
+5V	4.576	4.950	22.651
+5VSB	4.786	0.227	1.086
+12V	11.884	0.065	0.772
		Total Power Consumption	26.475

B.1.6. Functional Test – Run Passmark BurnIn test 6.0

Power Plane	Volts	Amperes	Watts
+3.3V	2.797	0.630	1.762
+5V	4.390	6.450	28.316
+5VSB	4.620	0.361	1.668
+12V	11.762	0.074	0.870
		Total Power Consumption	32.616

B.1.7. Network Access <Single LAN> – Gigabit Ethernet File Transmitting

Power Plane	Volts	Amperes	Watts
+3.3V	2.798	0.640	1.791
+5V	4.420	6.254	27.643
+5VSB	4.636	0.424	1.966
+12V	11.774	0.071	0.836
		Total Power Consumption	32.236

B.1.8. Network Access <Dual LAN> – Gigabit Ethernet File Transmitting

Power Plane	Volts	Amperes	Watts
+3.3V	2.966	0.730	2.165
+5V	4.489	7.204	32.339
+5VSB	4.710	0.452	2.129
+12V	11.880	0.090	1.069
		Total Power Consumption	37.702

B.2. VB7009-10E

The tests were performed based on the following additional components:

- **CPU:** VIA C7® 1.0GHz
- **Chipset:** VX900
- **Memory:** DDR3 DIMM Kingston HyperX 1600MHz 4GB
- **HDD SATA:** Fujitsu MJA2250BH 250GB
- **DVD-ROM:** Sony CRX890S
- **Power Supply:** ATX power supply SevenTeam ST-350GL 350W
- **Operating System:** Windows 7 32-bit

B.2.1. System Idle – Windows 7 32-bit

Power Plane	Volts	Amperes	Watts
+3.3V	3.248	0.700	2.274
+5V	4.969	1.545	7.677
+5VSB	5.173	0.053	0.274
+12V	12.052	0.035	0.422
		Total Power Consumption	10.647

B.2.2. S3 Status – Windows 7 Sleep

Power Plane	Volts	Amperes	Watts
+3.3V	-0.016	0.000	0.000
+5V	-0.008	0.009	0.000
+5VSB	5.071	0.365	1.851
+12V	-0.017	0.005	0.000
		Total Power Consumption	1.851

B.2.3. MP3 Playback – Windows Media Player10

Power Plane	Volts	Amperes	Watts
+3.3V	3.233	0.710	2.295
+5V	4.942	1.827	9.029
+5VSB	5.145	0.062	0.319
+12V	12.051	0.031	0.374
		Total Power Consumption	12.017

B.2.4. DVD Playback – PowerDVD 8.0

Power Plane	Volts	Amperes	Watts
+3.3V	3.186	0.700	2.230
+5V	4.880	2.060	10.053
+5VSB	5.085	0.071	0.361
+12V	12.030	0.040	0.481
		Total Power Consumption	13.125

B.2.5. Graphics – Run 3DMarks'06

Power Plane	Volts	Amperes	Watts
+3.3V	3.175	0.700	2.223
+5V	4.863	2.191	10.655
+5VSB	5.071	0.074	0.375
+12V	12.002	0.040	0.480
		Total Power Consumption	13.733

B.2.6. Functional Test – Run Passmark BurnIn test 6.0

Power Plane	Volts	Amperes	Watts
+3.3V	3.221	0.710	2.287
+5V	4.918	2.050	10.082
+5VSB	5.124	0.068	0.348
+12V	12.049	0.033	0.398
		Total Power Consumption	13.115

B.2.7. Network Access <Single LAN> – Gigabit Ethernet File Transmitting

Power Plane	Volts	Amperes	Watts
+3.3V	3.083	0.700	2.158
+5V	4.700	3.573	16.793
+5VSB	4.868	0.147	0.716
+12V	11.961	0.045	0.538
		Total Power Consumption	20.205

B.2.8. Network Access <Dual LAN> – Gigabit Ethernet File Transmitting

Power Plane	Volts	Amperes	Watts
+3.3V	3.078	0.690	2.124
+5V	4.695	3.606	16.930
+5VSB	4.864	0.144	0.700
+12V	11.954	0.040	0.478
		Total Power Consumption	20.232

B.3. VB7009-12QCE

The tests were performed based on the following additional components:

- **CPU:** CNR C4250 X4 1.2+GHz
- **DDR III:** Corsair 1600MHz 4GB
- **HDD SATA:** Fujitsu MJA2250BH 250GB
- **Power Supply:** ATX power supply ENERMAX EG701AX-VH 350W
- **Meter:** YOKOGAWA DR232-12-00-1D
- **Operating System:** Windows 7 64bit

B.3.1. System Idle – Windows 7 64bit

MAX	Volts	Amperes	Watts
+3.3V	3.161	0.722	2.282
+5V	4.930	2.333	11.502
+5VSB	5.066	0.144	0.730
+12V	12.401	0.030	0.372
		Total Power Consumption	14.885

MEAN	Volts	Amperes	Watts
+3.3V	3.155	0.711	2.243
+5V	4.927	2.133	10.509
+5VSB	5.064	0.037	0.187
+12V	12.395	0.021	0.260
		Total Power Consumption	13.200

B.3.2. S3 Status – Windows 7 Sleep (EuP Disable)

MAX	Volts	Amperes	Watts
+3.3V	-0.019	-0.011	0.000
+5V	-0.015	-0.021	0.000
+5VSB	5.159	0.416	2.146
+12V	0.119	-0.010	-0.001
		Total Power Consumption	2.146

MEAN	Volts	Amperes	Watts
+3.3V	-0.019	-0.018	0.000
+5V	-0.020	-0.036	0.001
+5VSB	5.157	0.413	2.130
+12V	-0.017	-0.021	0.000
		Total Power Consumption	2.130

B.3.3. MP3 Playback – Windows Media Player10

MAX	Volts	Amperes	Watts
+3.3V	3.163	0.747	2.363
+5V	4.958	3.142	15.578
+5VSB	5.079	0.130	0.660
+12V	12.404	0.035	0.434
		Total Power Consumption	19.035

MEAN	Volts	Amperes	Watts
+3.3V	3.146	0.731	2.300
+5V	4.902	2.273	11.142
+5VSB	5.045	0.057	0.288
+12V	12.387	0.020	0.248
		Total Power Consumption	13.977

B.3.4. MP4 Playback –KM Player10

MAX	Volts	Amperes	Watts
+3.3V	3.148	0.744	2.342
+5V	4.940	2.930	14.474
+5VSB	5.068	0.158	0.801
+12V	12.405	0.025	0.310
		Total Power Consumption	17.927

MEAN	Volts	Amperes	Watts
+3.3V	3.136	0.729	2.286
+5V	4.871	2.428	11.827
+5VSB	5.021	0.095	0.477
+12V	12.377	0.016	0.198
		Total Power Consumption	14.788

B.3.5. Graphics – Run 3DMarks'06

MAX	Volts	Amperes	Watts
+3.3V	3.145	0.735	2.312
+5V	4.939	3.225	15.928
+5VSB	5.061	0.221	1.118
+12V	12.384	0.023	0.285
		Total Power Consumption	19.643

MEAN	Volts	Amperes	Watts
+3.3V	3.131	0.708	2.217
+5V	4.855	2.541	12.337
+5VSB	5.009	0.107	0.536
+12V	12.368	0.014	0.173
		Total Power Consumption	15.262

B.3.6. Functional Test – Run Passmark BurnIn test 6.0

MAX	Volts	Amperes	Watts
+3.3V	3.133	0.731	2.290
+5V	4.875	3.166	15.434
+5VSB	5.030	0.212	1.066
+12V	12.389	0.023	0.285
		Total Power Consumption	19.076

MEAN	Volts	Amperes	Watts
+3.3V	3.125	0.717	2.241
+5V	4.820	2.725	13.135
+5VSB	4.985	0.017	0.085
+12V	12.364	0.051	0.631
		Total Power Consumption	16.090

B.3.7. Network Access <Dual LAN> – Gigabit Ethernet File Transmitting

MAX	Volts	Amperes	Watts
+3.3V	2.964	0.633	1.876
+5V	4.688	3.119	14.622
+5VSB	4.851	0.410	1.989
+12V	12.228	0.007	0.086
		Total Power Consumption	18.573

MEAN	Volts	Amperes	Watts
+3.3V	2.949	0.626	1.846
+5V	4.662	2.807	13.086
+5VSB	4.826	0.273	1.317
+12V	12.217	0.003	0.037
		Total Power Consumption	16.286

B.3.8. S5 Status – Windows 7 Shut down (EuP Disable)

MAX	Volts	Amperes	Watts
+3.3V	-0.010	-0.007	0.000
+5V	0.017	-0.010	0.000
+5VSB	5.165	0.365	1.885
+12V	-0.014	0.006	0.000
		Total Power Consumption	1.885

MEAN	Volts	Amperes	Watts
+3.3V	-0.017	-0.010	0.000
+5V	-0.018	-0.017	0.000
+5VSB	5.165	0.360	1.859
+12V	-0.016	-0.010	0.000
		Total Power Consumption	1.859

B.3.9. S5 Status – Windows 7 Shut down (EuP Enable)

MAX	Volts	Amperes	Watts
+3.3V	0.000	-0.003	0.000
+5V	0.001	0.007	0.000
+5VSB	5.210	0.015	0.078
+12V	0.001	-0.003	0.000
		Total Power Consumption	0.078

MEAN	Volts	Amperes	Watts
+3.3V	-0.001	-0.005	0.000
+5V	0.000	-0.008	0.000
+5VSB	5.209	0.014	0.073
+12V	-0.001	-0.006	0.000
		Total Power Consumption	0.073

Appendix C. Mating Connector Vendors List

The following table listed the mating connector vendors list of VIA VB7009 board.

Connector	Part No.	Mating Vendor & P/N	
F_Audio	99G30-05126I	Neltron	SAMTEC SSW Series
		2214S-XXG-85	
		2214R-XXG-85	
F_PANEL	99G30-05009I	Neltron	SAMTEC SSW Series
		2214S-XXG-85	
		2214R-XXG-85	
FAN	99G30-020035	Neltron	N/A
		2218H-03	N/A
Inverter	99G30-020537	ACES	MOLEX
		85206-0800	51021-**00
LVDS	99G30-170152	ACES	HRS
		44002-4000	DF13-**DS-1.258C
USB	99G30-05072K	Neltron	SAMTEC SSW Series
		2214S-XXG-85	
		2214R-XXG-85	

Table 35: VIA VB7009 mating connector vendors list



Taiwan Headquarters

1F, 531 Zhong-zheng Road,
Xindian Dist., New Taipei City 231
Taiwan

Tel: 886-2-2218-5452
Fax: 886-2-2218-9860
Email: embedded@via.com.tw



USA

940 Mission Court
Fremont, CA 94539,
USA

Tel: 1-510-687-4688
Fax: 1-510-687-4654
Email: embedded@viatech.com



Japan

3-15-7 Ebisu MT Bldg. 6F,
Higashi, Shibuya-ku
Tokyo 150-0011
Japan

Tel: 81-3-5466-1637
Fax: 81-3-5466-1638
Email: embedded@viatech.co.jp



China

Tsinghua Science Park Bldg. 7
No. 1 Zongguancun East Road,
Haidian Dist., Beijing, 100084
China

Tel: 86-10-59852288
Fax: 86-10-59852299
Email: embedded@viatech.com.cn



Europe

Email: embedded@via-tech.eu